

Eminere™
series

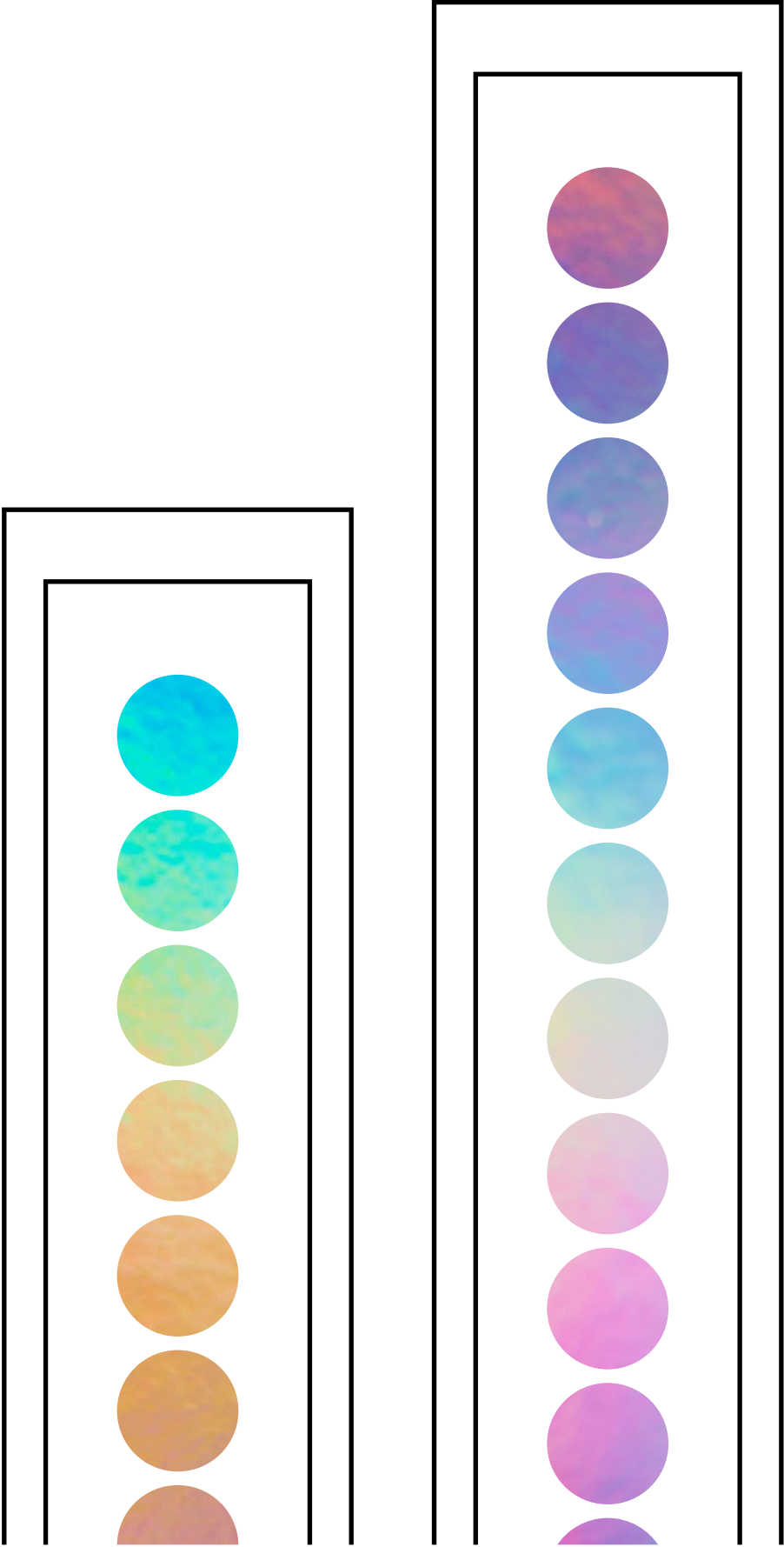

Eminere™ series by Anolis®

Anolis designs and manufactures the highest quality LED architectural lighting. All products are designed in our state of the art R&D facility by industry experts with over 10 years experience in their field. Our fixtures are extensively tested to ensure they perform perfectly in the environment they were designed for. Utilisation of the latest LED technology ensures low power consumption and long lumen maintenance intervals.

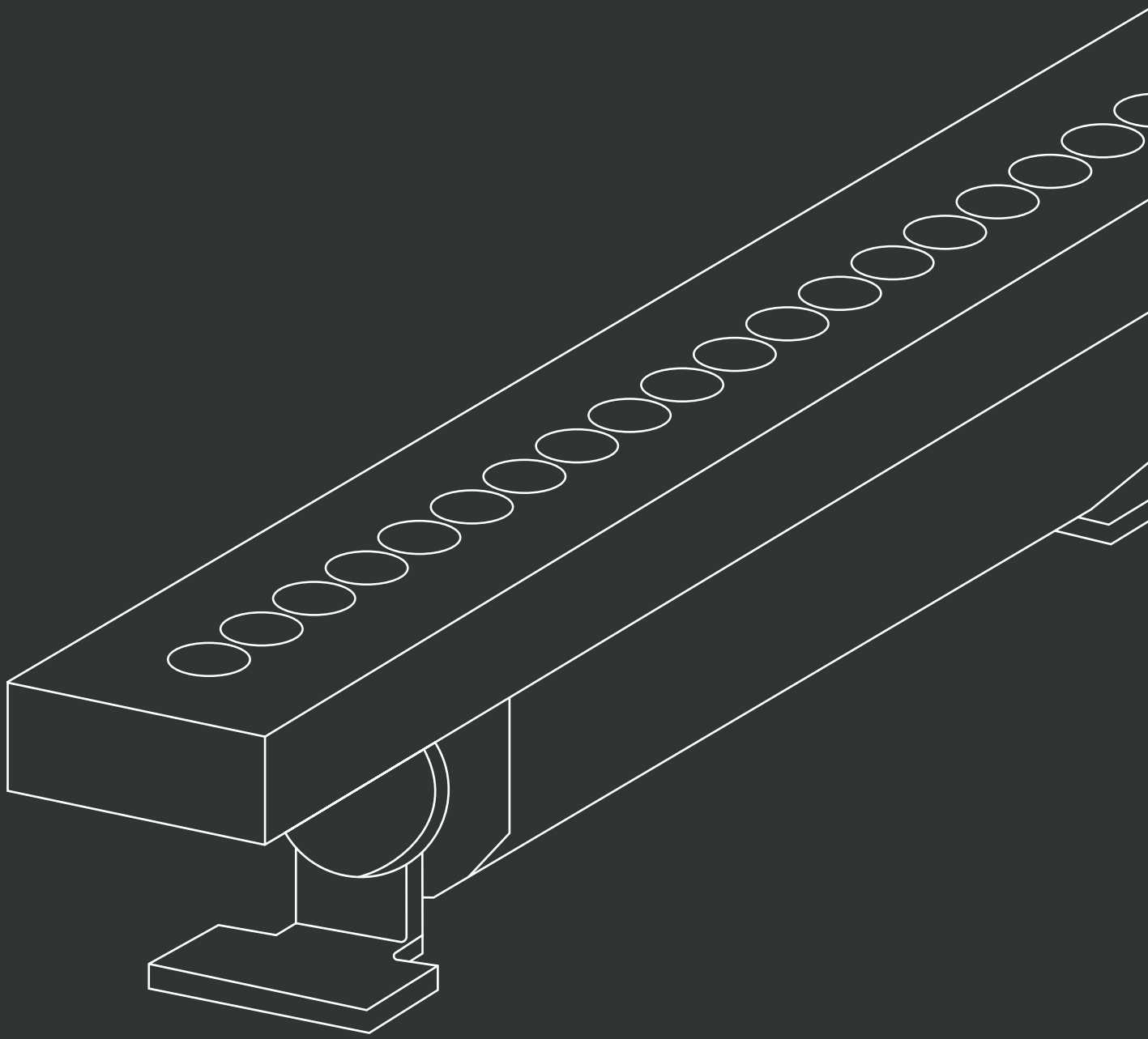

Content

About	6
Design	10
Selections	18
Colour Mixing	22
Application flexibility	24
Durability	30
Connectivity	32
Products	34

Anolis Lighting
Outdoor

Introduction

La Porte de Bourgogne, France

Eminere™ 1

Eminere™ 4

ArcSource™ Outdoor 48MC



Eminere™ series



Exclusive Lineup

The new Eminere range by Anolis builds on the success of the original ArcLine Outdoor Series with precision optics and is available in a variety of sizes. It's perfect for a wide range of exterior and interior applications such as Flood Lighting, Wall Grazing, Wall Washing and Accent Lighting. Built to exact standards, these linear fixtures are durable enough to withstand extreme environments whilst producing beautiful colours from the RGBW, RGBA or PureWhite LED chips.

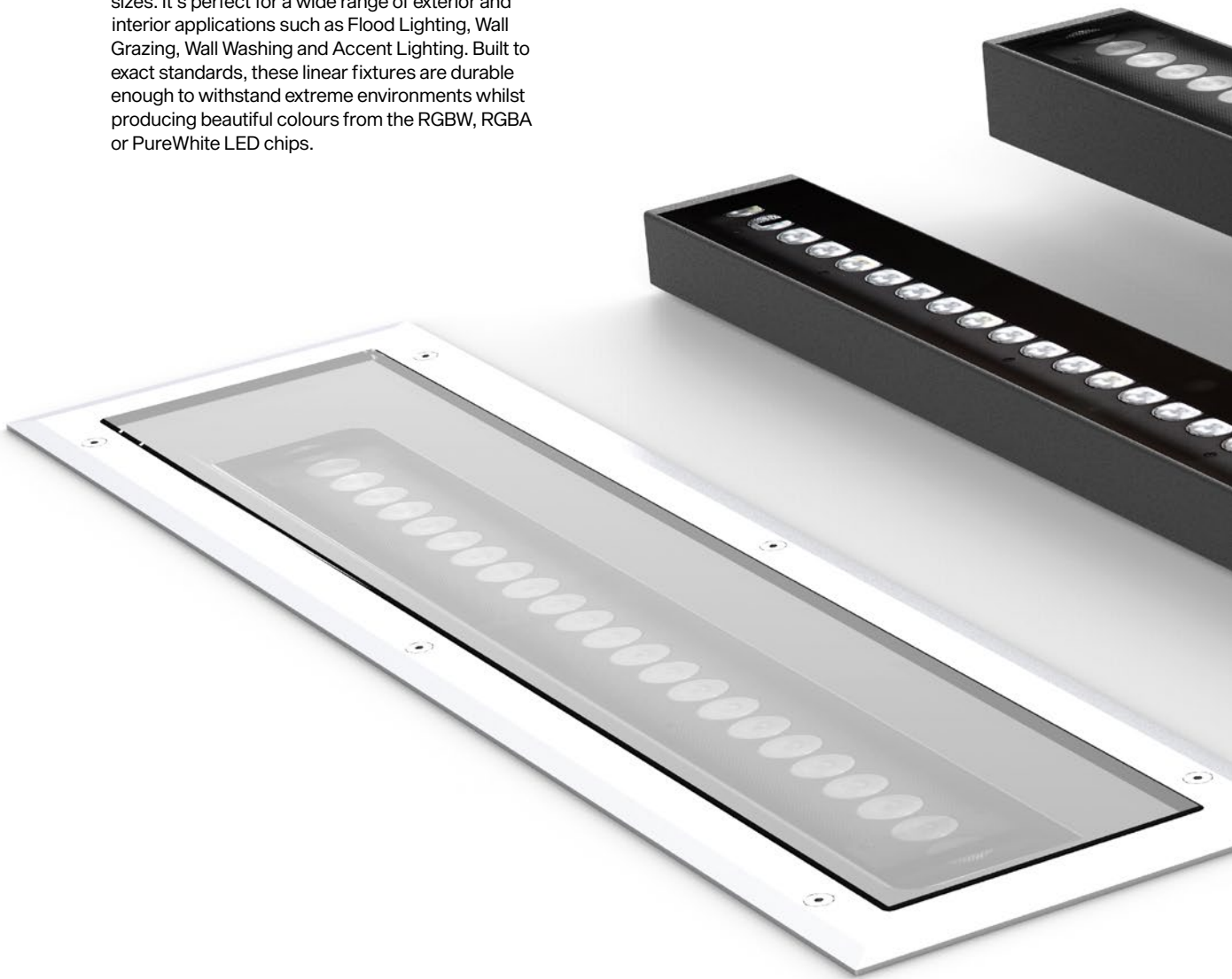

Versatile W



Vide Broad

Design

Anolis luminaires are developed with an emphasis on performance, flexibility, durability, control, and last but not least, design ingenuity. While quality and simplicity are the main characteristics of our Eminere range, they are designed to maximize application functionality in a robust physical housing. Its carefully chosen materials, smooth connections and edges, and multiple colour finish options, make Eminere an ideal lighting solution.

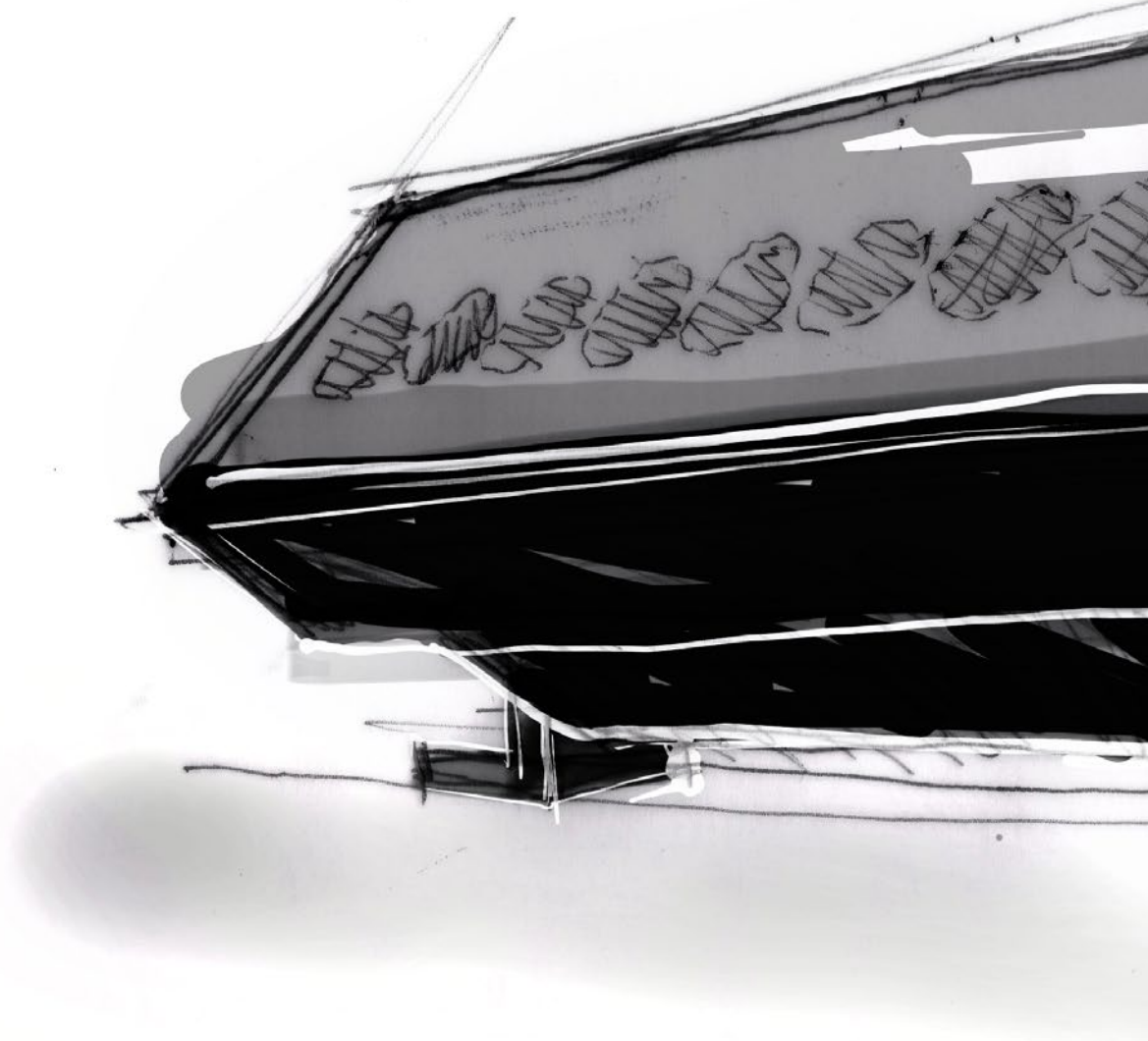

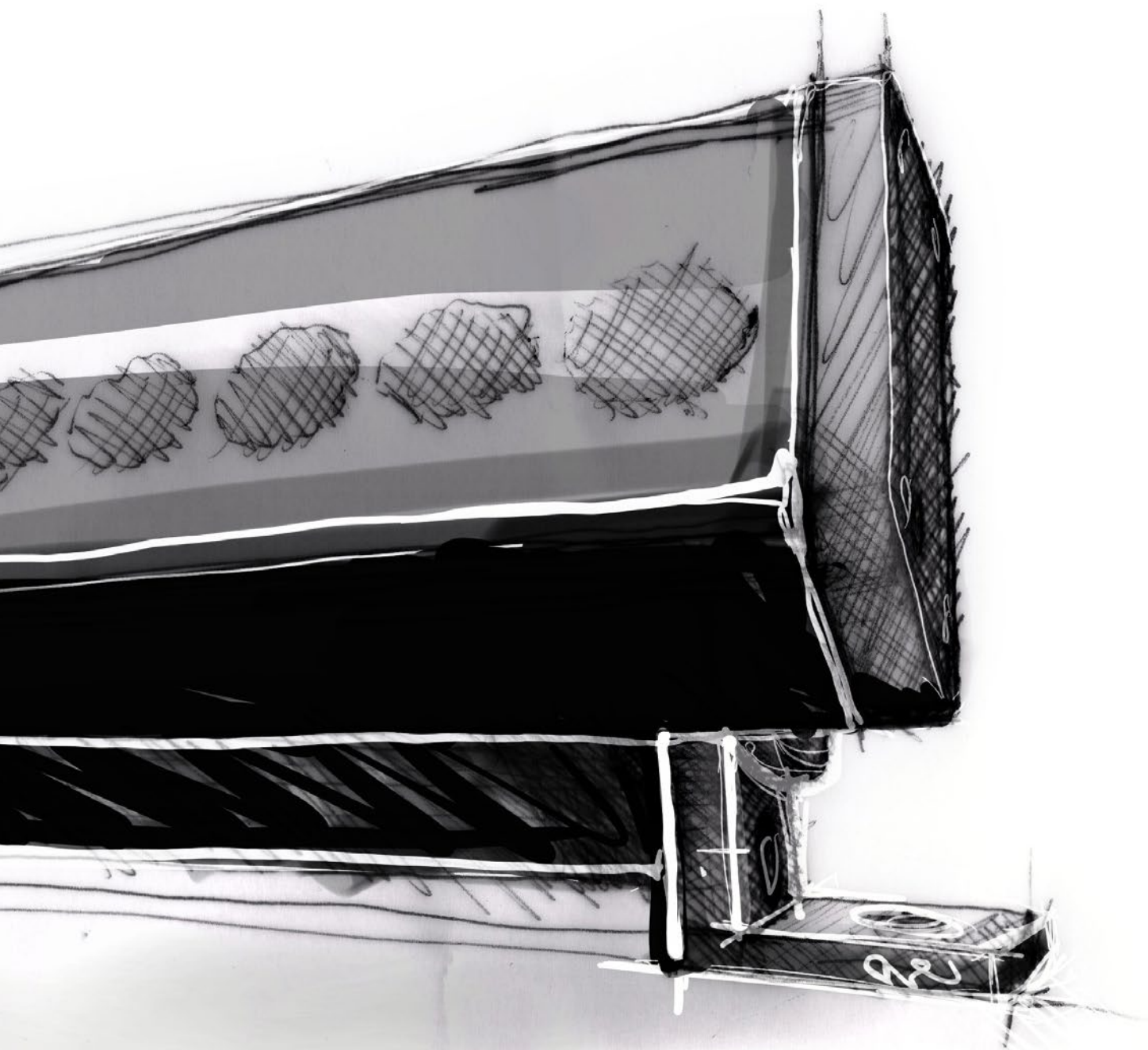

Precision in all its colours

Architectural lighting has never been easier with linear LED fixtures designed to be the new industry standard. Eminere's flexibility offers designers a powerful tool to meet the most demanding scenarios of placement, environment, and light distribution. The ability to select specific LED chips across a wide range of colour temperatures combined with high-quality holographic filters delivers precise colour mixing and exceptional beam definition.





Château de Barr, France

Eminere™ 4

Absolutely limitle ∞

Notre-Dame-du-Rosaire, France

Eminere™ 2/3/4



Notre-Dame-du-Rosaire

The façade of the famous Notre-Dame-du-Rosaire, Catholic shrine and minor basilica within the Sanctuary of Our Lady of Lourdes in southern France has a new Anolis lighting installation. The site is an international pilgrimage destination where the sick can reputedly be miraculously healed by the Lourdes water. Around 80 Anolis products from different ranges including Eminere 4s, Eminere 3s, Eminere 2s, ArcSource Outdoor 16MC, Divine 160s, Divine 72s, ArcPar 150 Outdoors, s and ArcSource Outdoor 4MC Pixels are lighting the basilica's façade, arcades, crown, cross, belfries, stairs, square, statues and lectern.

LED fixtures were chosen for their longer lifespan, lower power consumption and reduced maintenance. Anolis was selected for the breadth of its range of colour changing luminaires – with multiple options needed to precision light the different areas of the façade – as well as the quality of the light output, the brand's reliability and robust build for the outdoor environment plus DMX controllability.

Notre-Dame-du-Rosaire, France
-
Eminere™ 2/3/4



Design and Installation: BLEV
Organisation and ACE EVENT.

Façade as you wish

Green

Yellow

Yellow

White

Orange

Lime

Cyan

Gold

Pink

Coral

Red

Teal

Purple

Navy

Beige

Warm

Indigo

Aqua

Khaki

Blue

Gray

Linen

Azure



Blue

Green

Yellow

Azure

White

Orange

Lime

Cyan

Gold

Pink

Coral

Red

Teal

Purple

Navy

Beige

Teal

Indigo

Aqua

Khaki

Teal

Gray

Linen

with
Eminere™



Selections

Lengths

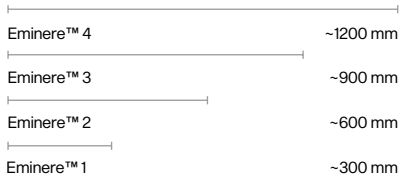

Light Colours



Colour Temperature

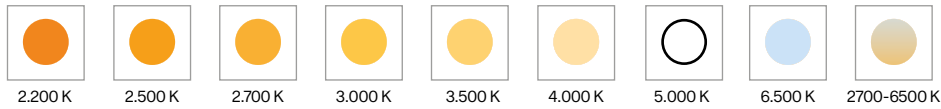

Finish Options

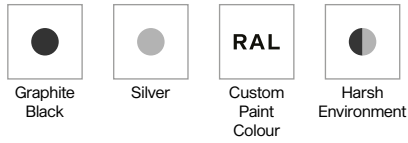

Standard & Specification



Fixture Control

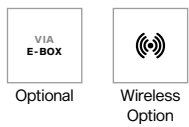

Optical options

Symmetrical:

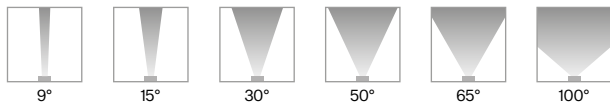

Bi-Symmetrical:

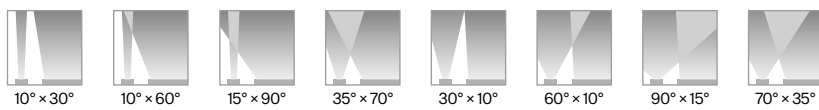

Asymmetrical

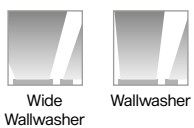

Eminere™ 1/2/3/4

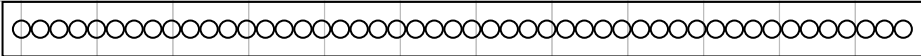

Eminere™ 4 | 76 x 1229 mm

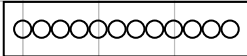

Eminere™ 1 | 76 x 329 mm



Eminere™ 3 | 76 x 929 mm



Eminere™ 2 | 76 x 629 mm

Eminere™ Side 1/2/3/4



Eminere™ Side 4 | 148 x 1229 mm



Eminere™ Side 1 | 148 x 329 mm

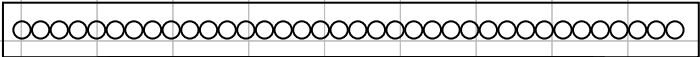

Eminere™ Side 3 | 148 x 929 mm

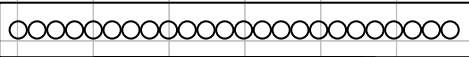

Eminere™ Side 2 | 148 x 629 mm

Eminere Inground™ 1/2/3

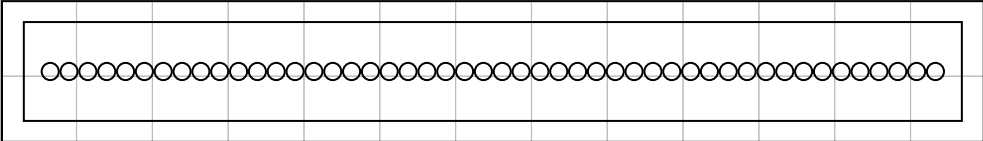
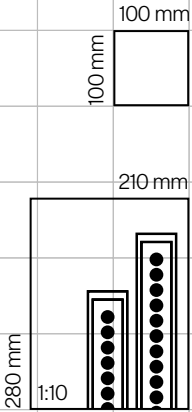

Eminere™ Inground 4 | 186 x 1307 mm

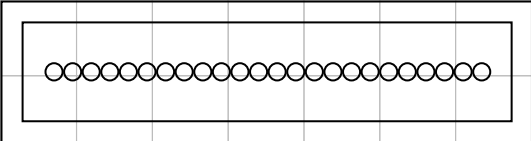

Eminere™ Inground 2 | 186 x 707 mm

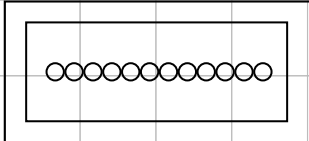

Eminere™ Inground 1 | 186 x 407 mm

Eminere Remote™ 1/2/3/4

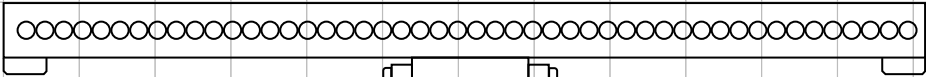

Eminere™ Remote 4 | 113 x 1229 mm

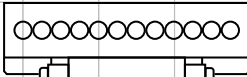

Eminere™ Remote 1 | 113 x 329 mm

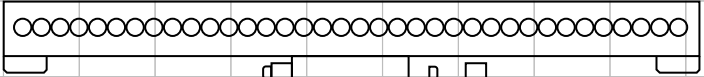

Eminere™ Remote 3 | 113 x 929 mm

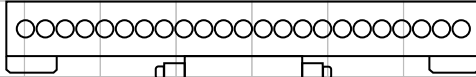

Eminere™ Remote 2 | 113 x 629 mm

Optical Performance

Eminere fixtures accommodate a combination of high power LEDs, specifically designed optics and a wide variety of optical foils with many different beam spreads. Selection of the correct configuration is quick and easy.



9°
4.588 lm
3.002 lx



15°
3.912 lm
1.057 lx



30°
4.184 lm
397 lx



50°
4.156 lm
205 lx



65°
4.160 lm
133 lx



100°
3.984 lm
62 lx

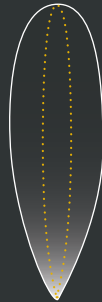

10° × 30°
4.128 lm
936 lx

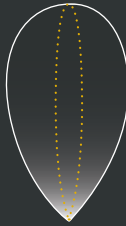

10° × 60°
3.748 lm
504 lx

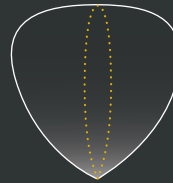

15° × 90°
3.880 lm
283 lx



35° × 70°
4.160 lm
198 lx



Wallwasher
3.806 lm
496 lx



Wide Wallwasher
3.416 lm
149 lx

Colour Mixing

The Eminere series offers a full spectrum of colours with the latest technology standards such as 18-bit resolution for stepless colour fades, amber-shift for sunrise / sunset emulation, internal CTO or green colour correction channel. Specifically designed glass printings help improve colour mixing and blend all LEDs into the desired hue.

Head2Head

Fixtures installed right next to each other create absolutely perfect colour and intensity overlap which helps outputted light hit surfaces in the desired colour tone.



Stand Alone

Specially designed glass printing to achieve optimal colour mixing and intensity distribution. No matter which colour pallet is chosen, output is always perfectly consistent and balanced from one side to the other.



Application Flexibility

Lighting design can be challenging and the result is dependent on the right application. Consider textured materials for wall grazing, homogenised output and uniform coverage for wall washing, picking up contours or specific passages for accent lighting and flood lighting is ideal for places that are not always easy accessible.

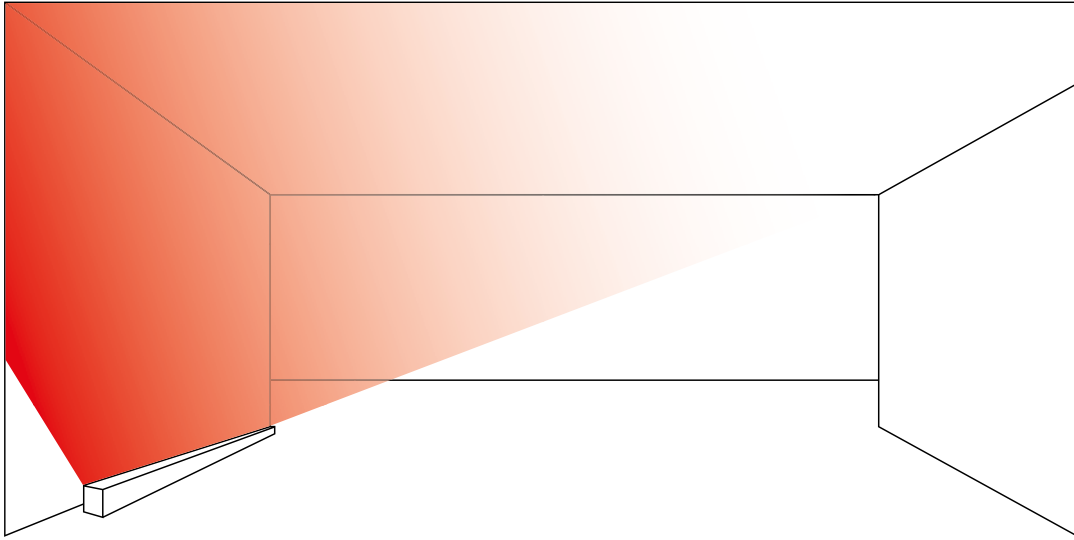

Flood Lighting

Using flooding optics gives flexibility to illuminate large areas with minimum fixture positioning requirements. Thinking about bridge arcades, giant walls or tunnels illumination? Flood lighting will be the right solution for you.

30°, 50°, 65°, 100°

Spacing: distance between head of luminaires
 Setback: distance from the wall to luminaire
 Av. illuminance: average illuminance on the wall
 min/av.: minimum value of illuminance on the wall
 average value of illuminance on the wall.

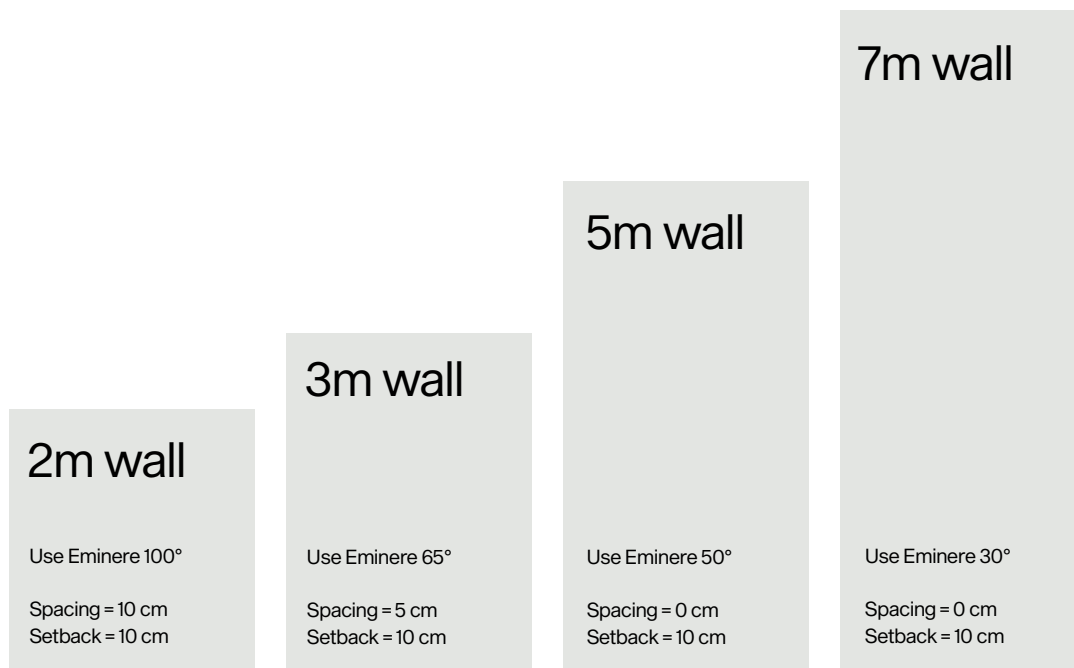

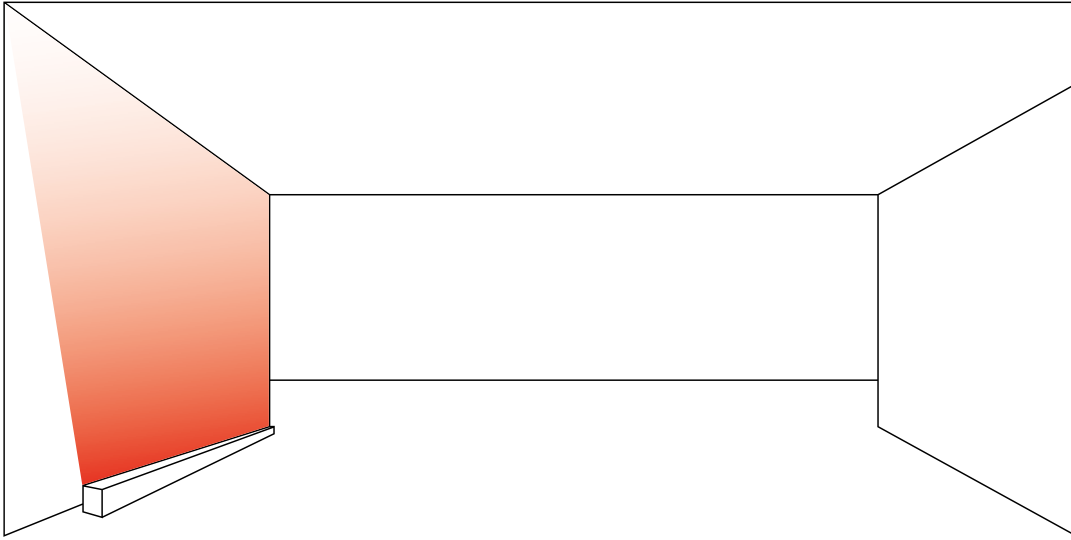

Wall Grazing

Place fixture close to the surface and let it highlight the texture of the illuminated material. Grazing is an ideal method to bring out every single detail and create a very natural look.

9°, 15°, 10° × 30°, 10° × 60°,
15° × 90°, 35° × 70°

2m wall

Use Eminere 15° × 90°
30° × 60°

Spacing = 10 cm
Setback = 10 cm

3m wall

Use Eminere 10° × 60°

Spacing = 5 cm
Setback = 10 cm

5m wall

Use Eminere 10° × 30°

Spacing = 0 cm
Setback = 10 cm

7m wall

Use Eminere 15°

Spacing = 0 cm
Setback = 10 cm

10m wall

Use Eminere 9°

Spacing = 0 cm
Setback = 10 cm

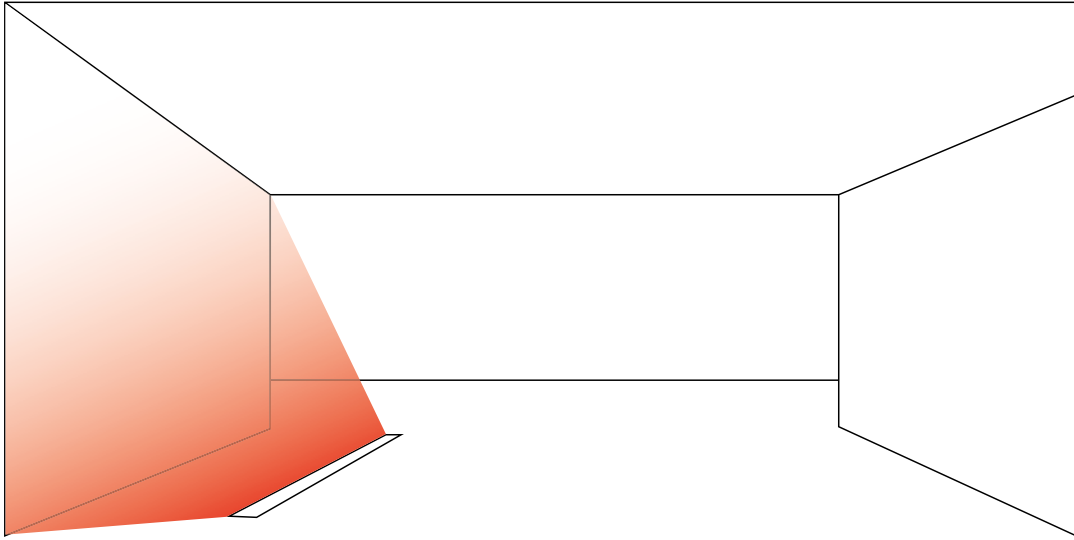

Wall Washing

Having distance between the fixture and the surface allows an even application of light that gives the surface texture a flat appearance.

Wall Washer Wide Wallwasher

2m wall	3m wall	5m wall	7m wall	10m wall
Use Eminere Wide Wallwasher	Use Eminere Wide Wallwasher	Use Eminere Wallwasher	Use Eminere Wallwasher	Use Eminere Wallwasher
Spacing = 65 cm Setback = 55 cm Av. illuminance: 650 lx (min/av. = 0,40)	Spacing = 150 cm Setback = 90 cm Av. illuminance: 300 lx (min/av. = 0,39)	Spacing = 40 cm Setback = 80 cm Av. illuminance: 400 lx (min/av. = 0,24)	Spacing = 90 cm Setback = 120 cm Av. illuminance: 257 lx (min/av. = 0,28)	Spacing = 90 cm Setback = 170 cm Av. illuminance: 160 lx (min/av. = 0,33)
Use Eminere Wide Wallwasher	Use Eminere Wide Wallwasher	Use Eminere Wide Wallwasher	Use Eminere Wide Wallwasher	Use Eminere Wide Wallwasher
Spacing = 65 cm Setback = 55 cm Av. illuminance: 650 lx (min/av. = 0,40)	Spacing = 150 cm Setback = 90 cm Av. illuminance: 300 lx (min/av. = 0,39)	Spacing = 350 cm Setback = 135 cm Av. illuminance: 107 lx (min/av. = 0,37)	Spacing = 390 cm Setback = 180 cm Av. illuminance: 75 lx (min/av. = 0,30)	Spacing = 450 cm Setback = 235 cm Av. illuminance: 50 lx (min/av. = 0,37)

Anolis Lighting
Outdoor

Eminere™
series

Notre Dame du Rosaire, France

Eminere™ 2
Eminere™ 3
Eminere™ 4



Eminere™ series



Will it survive?

Every member of the Eminere series is equipped with the latest technology to meet market standards and the high expectations of lighting designers. Its classified ingress protection of IP67 declares usability in wet locations, and vibration testing allows use of the Eminere series in high traffic areas and on bridges. A special coating means Eminere fixtures can withstand marine or harsh conditions, and the Inground models have an IK9 rating with anti-skid options available. All Eminere luminaires are tested for extreme operating temperatures and come with a 5-year limited customer warranty.



Outdoor usage

IP67 rated fixtures suitable for wet locations

Vibration standards for bridge applications

meets IEC 60598-1 and 3G ANSI C136.31

Extreme temperatures

-20 °C to +40 °C (-4 °F to +104 °F) operating temperatures

Warranty for 5 years

with LED lifespan over 90.000 hours (L90B10, Ta = 25°/77 °F)

Harsh environment

Suitable for salt spray environments and extreme outdoor applications.



Yes.

click





Connection on one click

The entire Eminere series was designed for both detail and simplicity, with key benefits for installers and system integrators including fast, efficient, and error free wiring and connection. Click-on connectors ensure that everything goes together safely and quickly and makes it simple to remove and replace fixtures for maintenance. Long runs with large quantities of fixtures are facilitated via a wide range of AC mains voltages and various options for cable topology including daisy chain and star configurations. Custom-made, IP67 rated factory molded combination power and data cables and IP67 panel connectors provide maximum protection against water ingress under all circumstances, even when a cable is unplugged.

Eminere™ series

Product
Type

Product Overview
Page Number

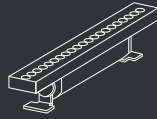

Eminere™

36–37

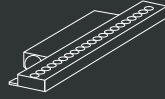

Eminere™ Side

38–39

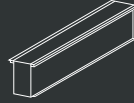

Eminere™ Inground

40–41

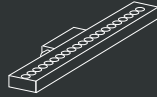

Eminere™ Remote

42–43

Eminere™



Eminere was designed by Anolis for a wide range of exterior and interior applications with a variety of lens options that can be used for flood lighting, wall grazing, wall washing and accent lighting. Equipped with Anolis' unique 18-bit colour mixing resolution ensures extra fine colour tuning as well as smooth dimming at low level of intensity. Designed in our state of the art R&D facility by industry experts with over 10 years experience in their field, Eminere is IP67 rated and can withstand extreme conditions. Eminere is available in 1, 2, 3, and 4 foot sizes (300/600/900/1200 mm) with RGBW, RGBA or PureWhite single chips as standard and is easy to control, 1 pixel per foot. Eminere fixtures can be used for both permanent and temporary installations, including various architectural and architainment applications.



Scale

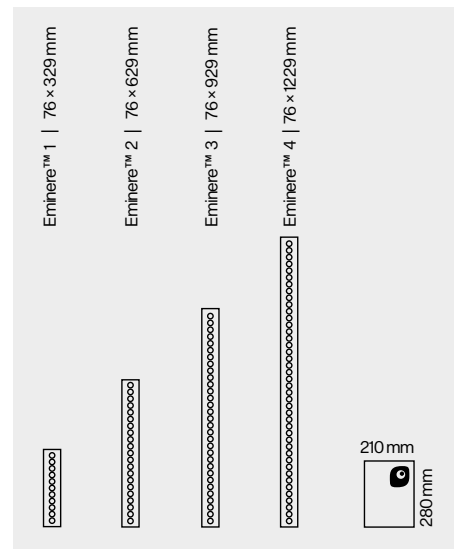

Quick and Easy Installation

Plug & Play system means easy installation, fast adjustment and intuitive programming with self-addressing.

Durability

Eminere is rated IP67, suitable for wet locations and has a protection rating of IK06. Marine grade finish option also available for harsh environmental conditions.

Application Flexibility

Eminere's optics can be used for various applications including wall grazing, flood lighting, wall washing, wide flood lighting, spot lighting and accent lighting.

Naturally Looking Result

Full spectrum coverage by using RGBW colour mixing with precise wavelengths of each colour for modern architecture or specifically designed combination of RGBA to highlight every single detail of historical buildings or monuments. Output up to 1147 lm (RGBW) or 1652 lm (PW) per one foot of Eminere.

Product Variant



Finish Options

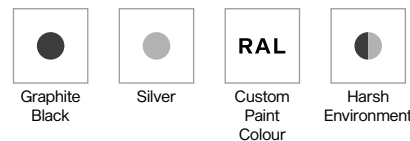

Optic Options

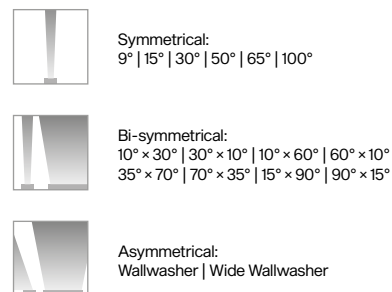

Control & Protocols

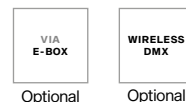

Standards and Certifications

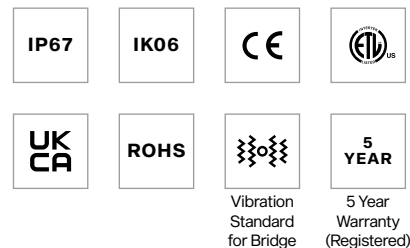

Eminere™ Side



Eminere Side is specifically designed for applications where a low form factor is required whilst keeping installation of the luminaire neat and clean. With only 76 mm in height, it keeps all of the Eminere series strengths. Wide range of optics options, durability, connectivity, application flexibility make this luminaire ideal solution for flood lighting, wall grazing, wall washing and accent lighting.



Scale

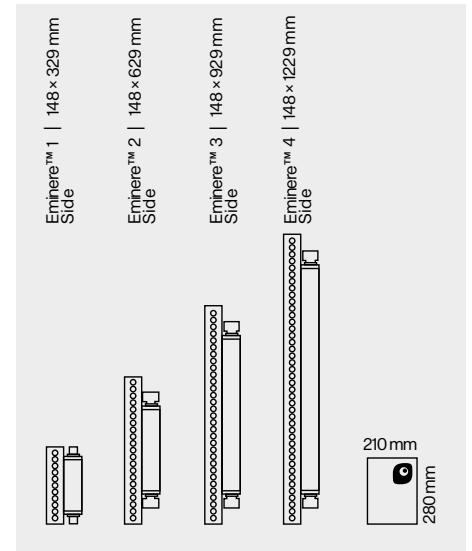

Quick and Easy Installation

Easy and quick installation using click-on connectors overmoulded on combo cable (Power + Data).

Durability

High durability of IK06 in combination of ingress factor IP67.

Application Flexibility

Complete solution for illuminating buildings, monuments, walls, statues, bridges, coves, arches and much more. With PSU on its side, Eminere Side is only 76 mm in height.

Optics & Colours

Wide range of optics allows to place product anywhere needed with no limitation. Full spectral LEDs selection with custom option on request. Output up to 1147 lm (RGBW) or 1652 lm (PW) per one foot of Eminere.

Product Variant



Finish Options

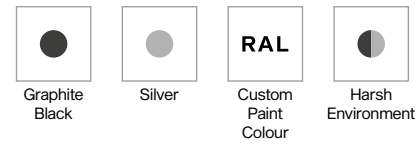

Optic Options

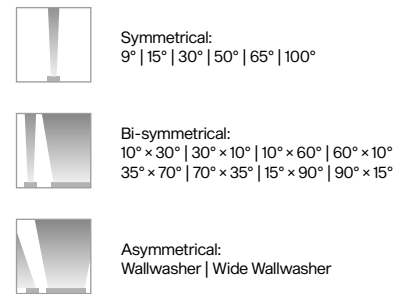

Control & Protocols

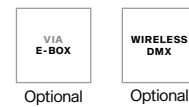

Standards and Certifications

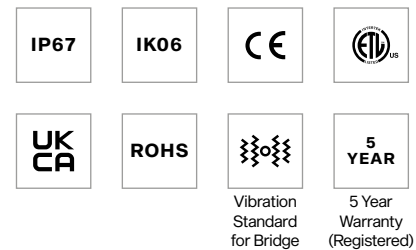

Eminere™ Inground



Eminere Inground is a robust luminaire designed to be installed into the ground. A stainless steel installation sleeve provides rust protection as well as “armour” for the Eminere fixture itself. Overall, Eminere Inground comes with an IP67 protection factor, standard or Anti-skid glass, and as always, perfect colour mixing. With $\pm 15^\circ$ tilt adjustment, precision optics with wide range of beam angles and colour variants, in-ground version of the Eminere luminaire is great choice for an exterior applications such as flood lighting, wall grazing, wall washing and accent lighting.



- Application** Anti-skid glass option for pedestrian areas application. Easy to install into soft and hard ground.
- Light Source** Full spectral LEDs selection with custom option on request. Output up to 2019 lm for Eminere Inground 2 RGBW. Long LED lifetime over 90,000 hrs. Manually adjustable tilt $\pm 15^\circ$ for fine adjustment of light beam.
- Durability** High durability with ingress factor of IP67 and walkover housing made from stainless steel with welded support for highest durability requirements.

Scale

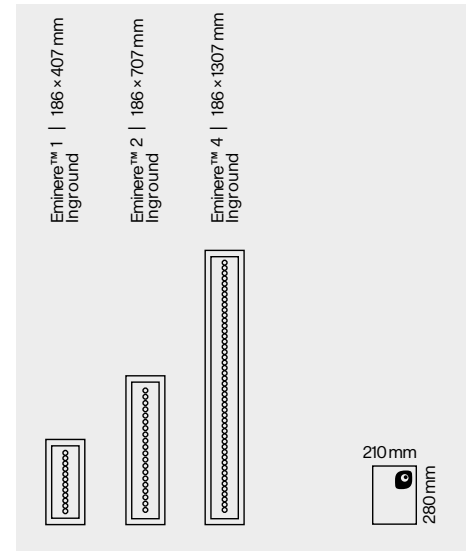

Product Variant



Finish Options



Optic Options



Symmetrical Clear Glass:
9° | 15° | 30° | 50° | 65° | 100°
Symmetrical Anti-Skid Glass:
18° | 22° | 35° | 50° | 65° | 100°



Bi-symmetrical Clear Glass:
10° x 30° | 10° x 60° | 15° x 90° | 35° x 70°
Bi-symmetrical Anti-Skid Glass:
20° x 35° | 20° x 65° | 20° x 90° | 40° x 70°



Asymmetrical:
Wallwasher | Wide Wallwasher

Control & Protocols



Optional



Optional

Standards and Certifications



Vibration Standard for Bridge

5 Year Warranty (Registered)

Eminere™ Remote



The newest member of the Eminere product range, Eminere Remote extends our series of linear architectural fixtures into further application possibilities using only low voltage for higher safety restrictions. Available in four sizes, ranging from 1 to 4 feet, Eminere Remote follows the identical optical and performance features of our other established and proven Eminere fixtures. Design-wise, Eminere Remote brings all of today's technology into an elegant and slim body, but is still very robust with an IP67 rating to withstand the harshest environments.



Scale

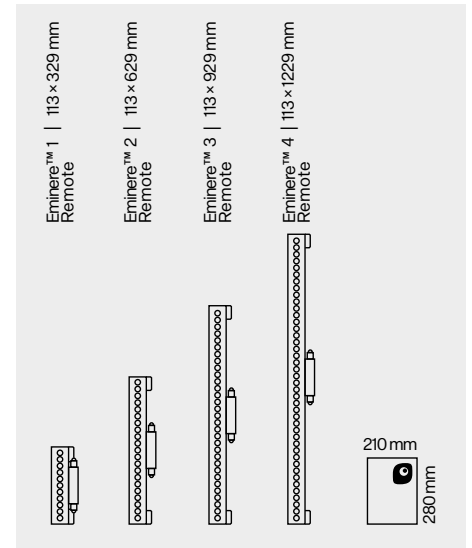

Optic & Control Output up to 1147 lm (RGBW) or 1652 lm (PW) per one foot of Eminere. With a wide range of optics for limitless fixture applications, Eminere Remote can also be operated in pixel (12 LEDs) or fixture modes, and its low-input voltages allow the luminaire to be used in applications with higher safety restrictions.

Product Variant



Finish Options

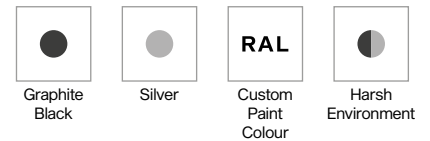

Optic Options

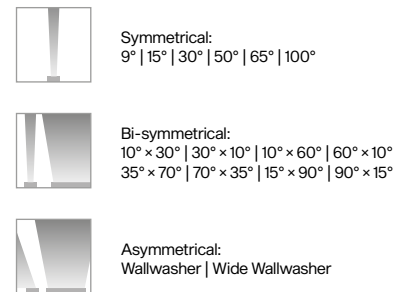

Control & Protocols



Standards and Certifications

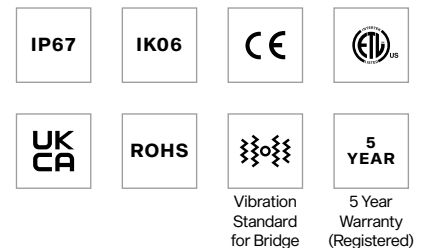

Compact Design At only 39 mm of total height, Eminere Remote is the thinnest lighting solution in our Eminere series and has been designed as a compact and slim LED luminaire suitable for any low-profile application.

Durability Thanks to its tempered glass and high-pressure, extruded aluminium housing, Eminere Remote is IK06 and IP67 certified. For more extreme and marine applications, a harsh environment finish option is also available.

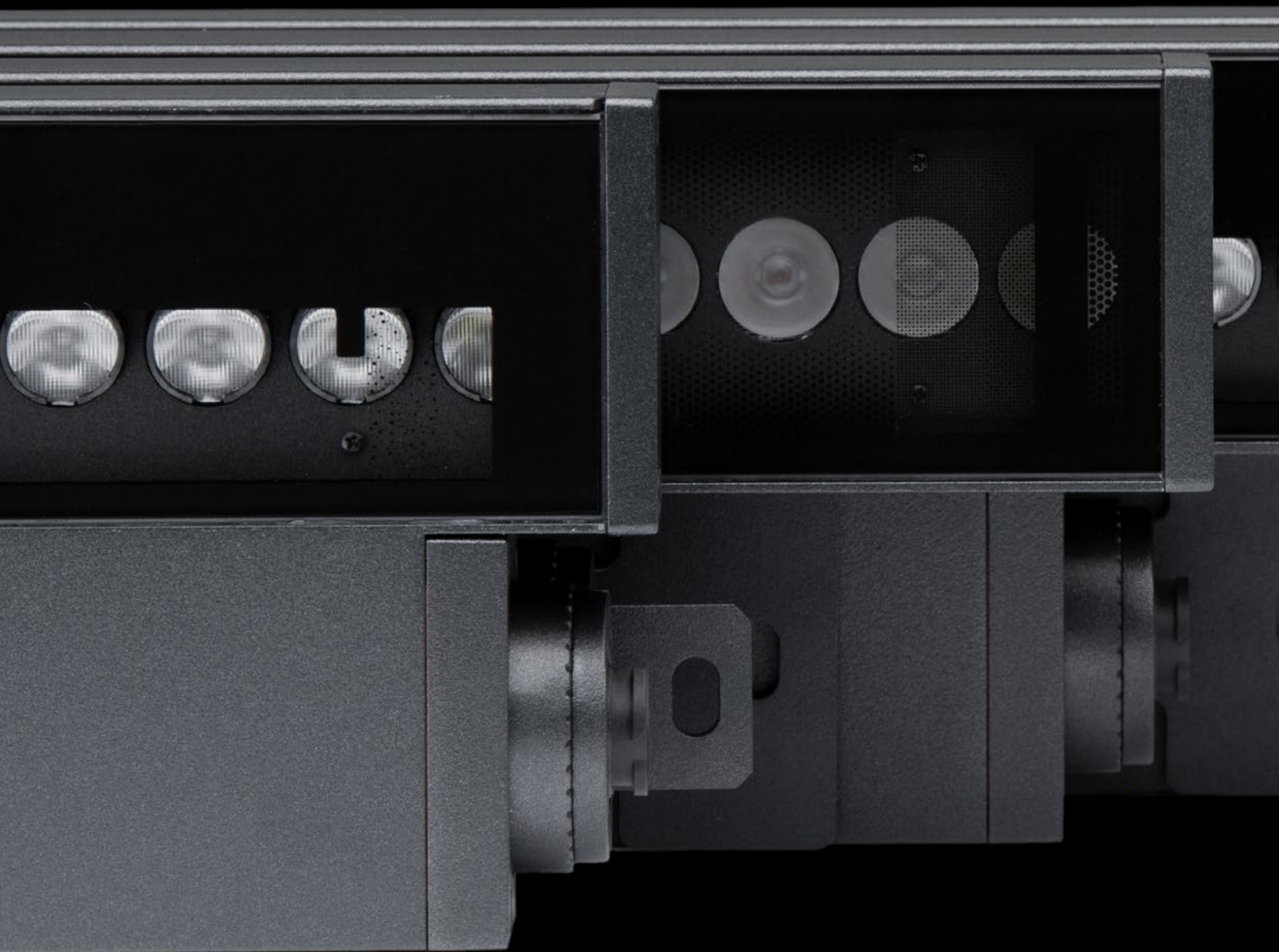

Eminere™ series



www.anolislighting.com

info@anolis.eu
+420 571 751 500

Head Office

Anolis
Hážovice 2090
756 61 Rožnov pod Radhoštěm
Czech Republic

Factory

Anolis
Palackého 416
757 01 Valašské Meziříčí
Czech Republic

Graphics, composition
KNOW HOW solutions s.r.o.

Print shop
GRASPO CZ, a.s.

Issue
EN 09/2022

© August 2022 Anolis
All specifications subject to change without notice.

