

QR code for Installations Instructions



The unit must be installed by a qualified electrician in accordance with all national and local electrical and construction codes and regulations. This device falls under class I and must be grounded!



The Ambiane Power Rack has 8 LED outputs and is desing for mounting into 19-inch equipment rack.

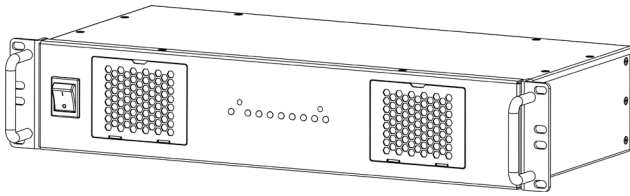

**STEP 1
AMBIANE POWER RACK CONNECTION (ONLY POWER)**

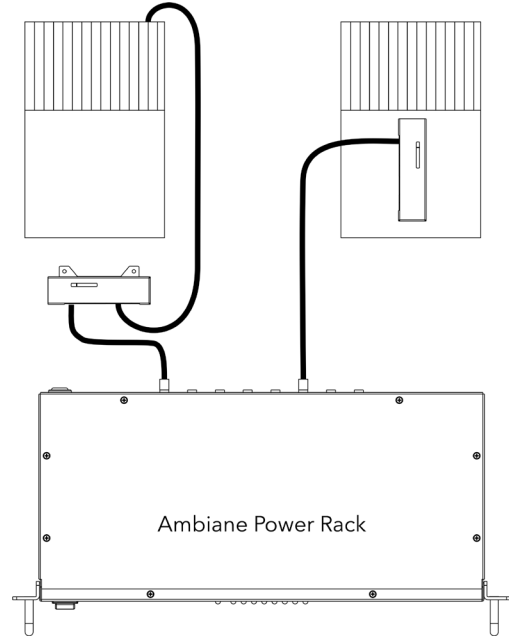

Connection of luminaire's power supply and Ambiane Power Rack.

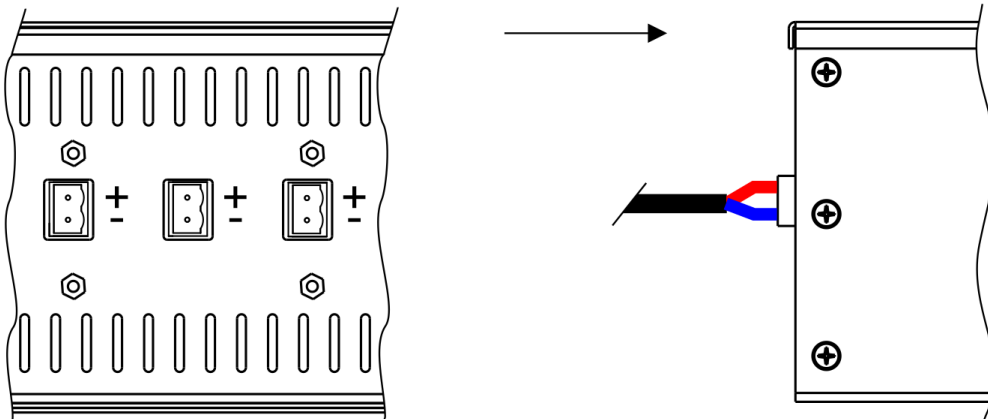
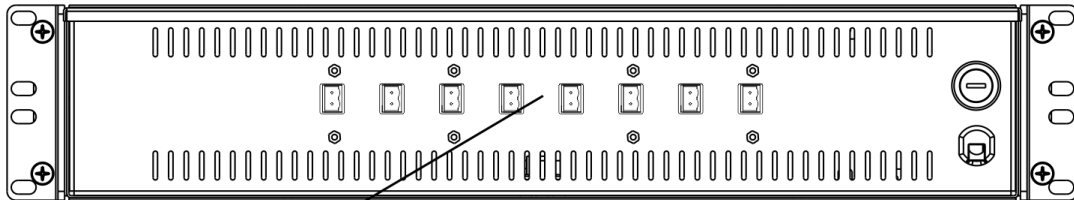

Install a terminal block on power cable and connect to the Ambiane Power Rack.

STEP 2
AMBIANE POWER RACK INSTALLATION

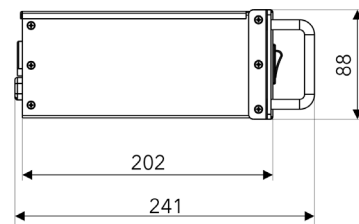
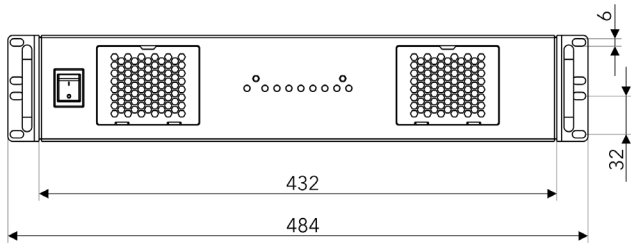

1

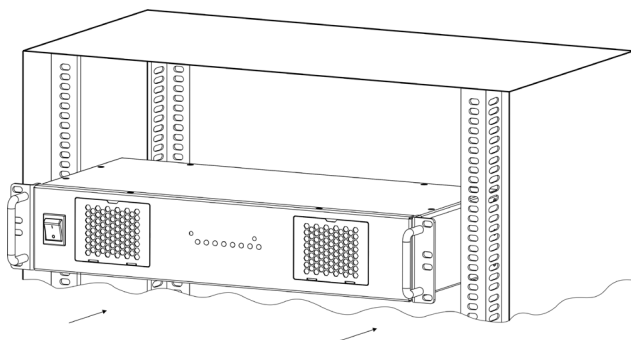

Insert the Ambiane Power Rack into the 19" equipment rack.

2

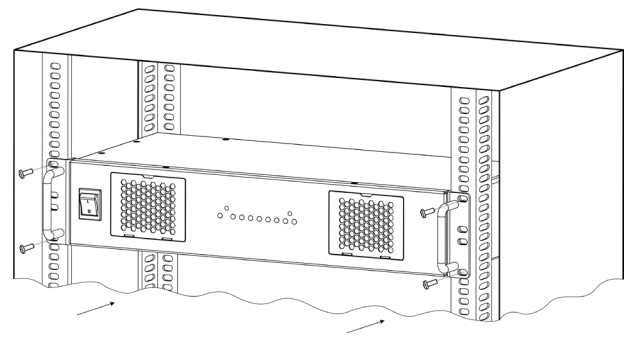

Fasten the Ambiane Power Rack into rack by means of two screws on each side of the Ambiane Power Rack .