

## AMBIANE® SP16 RECESSED

The smallest luminaire of Ambiane range with only 108 mm in diameter offers efficient, powerful and high-quality solution for lower ceiling recessed applications. Highly efficient LED module with CRI 90+, no UV or IR emissions, CCT and green correction settings is perfect for museums, art galleries, theaters, concert halls and other most demanding installations. Sharing the same LED chip-set with other Ambiane fixtures it complements the range and gives lighting designers even more options for various interior lighting installations.



### KEY FEATURES

#### Lumen output & Light source

Available in wide range of colour configurations (RGBW, PW, TW, TD), the Ambiane SP16 Recessed utilises highly efficient LED modules with CRI 90+. The fixture offers two different beam spreads of 30° and 60°.

#### Control

Using DALI or USITT DMX512 control protocols, with RDM support, Ambiane SP16 Recessed can be remotely controlled and managed. Ambiane SP16 Recessed also offers intelligent power balancing.

#### Installation

With compact dimensions, Ambiane SP16 Recessed is suitable for lower ceiling applications and to complement our more powerful luminaires of Ambiane range. Ambiane SP16 Recessed is convection cooled for silent operation without fans.

### COLOURS

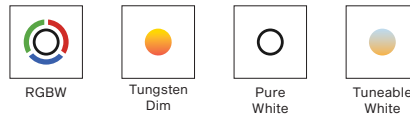

### COLOUR TEMPERATURE

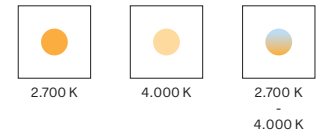

### CONTROL & PROTOCOLS



### OPTIC OPTIONS

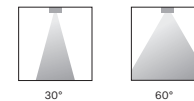

### STANDARD & SPECIFICATION

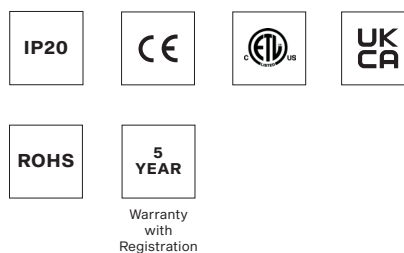

### FINISH OPTIONS

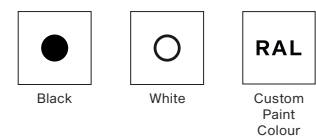

**SPECIFICATION**

<b>ELECTRICAL</b>	Input Voltage	48 V DC			
	Input Voltage range	44-50 V DC			
	Max. Power Consumption	10 W			
<b>OPTICAL</b>	Light Source	High Power LED module			
	Colour Variants	RGBW (W 2700 K or 4000 K)	Pure White	Tunable White	Tungsten Dim
	Colour Temperature of White	PW 2700 K or 4000 K   TW 2700-4000 K   TD 3200 K			
	CRI	90+			
	Beam Angle	30°   60°			
	Lumen Output Delivered	481 lm (RGBW at 30° White LEDs only)			
		518 lm (RGBW at 60° White LEDs only)			
Projected Lumen Maintenance	L90B10 >90.000 hrs, Ta = 25°C / 77°F				
<b>CONTROL</b>	Interface Protocol	USITT DMX512, RDM, DALI 2, 0-10 V			
	DALI 2 Device Type	DT 8			
	Control System	ArcControl Range or any Third Party Controller			
	DMX Modes	5 (for RGBW version)			
	DMX Channels	4, 3, 12, 3, 6			
	Settings / Addressing	DIP Switch, RDM			
	Power Supply	Ambiane Power AP (up to 4x Ambiane SP16)			
Ambiane Power Rack (up to 4x Ambiane SP16 per output)					
<b>PHYSICAL</b>	Diameter x Height	Ambiane SP16 Recessed 30° - ø108 x 110 mm (ø4.2 x 4.3 in.)			
		Ambiane SP16 Recessed 60° - ø108 x 100 mm (ø4.2 x 3.9 in.)			
	Weight	0.49 kg   1.08 lbs			
	Housing	Die-Cast Aluminium Body			
	Trim Finish Options	Standard Color - White RAL9016   Black RAL9005			
		Cost Option - Custom RAL			
	Cables / Connections	Terminal block (Power In, DMX In/Out, DALI In/Out, Secondary Power Input)			
	Mounting Method	Recessed, Via Spring Clips. Cut-Out Diameter: 90 mm / 3.5 in			
		Recessed, Via Yoke (Spring Clips not included)			
		Recessed, Trimless, Bayonet mounting method Cut-Out Diameter: 110 mm / 4.3 in			
	Protection Factor	IP20 / Dry location only			
	Cooling System	Convection			
	Operating Ambient Temperature	-20 °C / +40 °C (-4 °F / +104 °F) (TBC)			
Max. Operating Temperature	+75°C (167°F) (TBC)				
<b>CERTIFICATION</b>	Listings	ETL / cETL, RoHS, CE, UKCA			
<b>ACCESSORIES</b>	<b>Included Items</b>	Control Unit for Ambiane SP16			
	<b>Not Included Items</b>	Ambiane Power Rack (CE/US)			
		Ambiane Power AP			

**DIAMETER OF CONDUCTORS**

Recommended diameters of conductors with respect to distance between Fixture and Power supply (per 4pcs of Ambiane SP16)

<b>Distance / Cable length</b>	100 m
<b>Diameters of conductors</b>	1 mm²

**DIMENSIONS**

Ambiane SP16 Recessed - standard

30° H = 110 mm [4 5/16" inch]  
 60° H = 100 mm [3 15/16" inch]

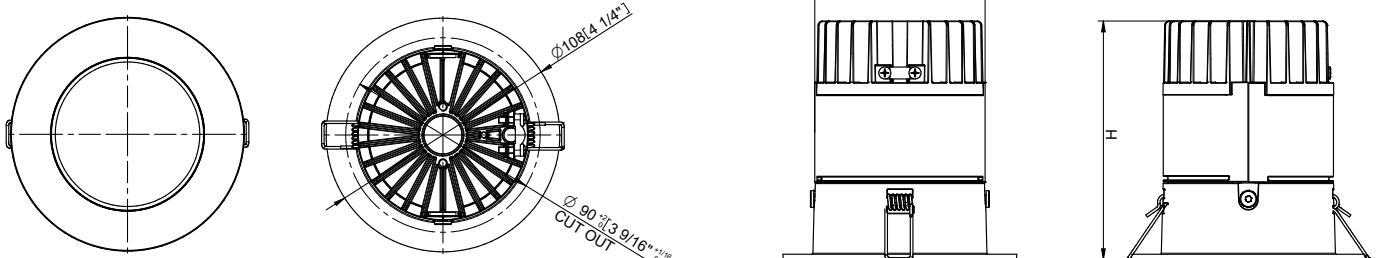

Ambiane SP16 Recessed - version with Yoke

30° H = 110 mm [4 5/16" inch]  
 60° H = 100 mm [3 15/16" inch]

30° H2 = 138 mm [5 5/16" inch]  
 60° H2 = 128 mm [4 15/16" inch]

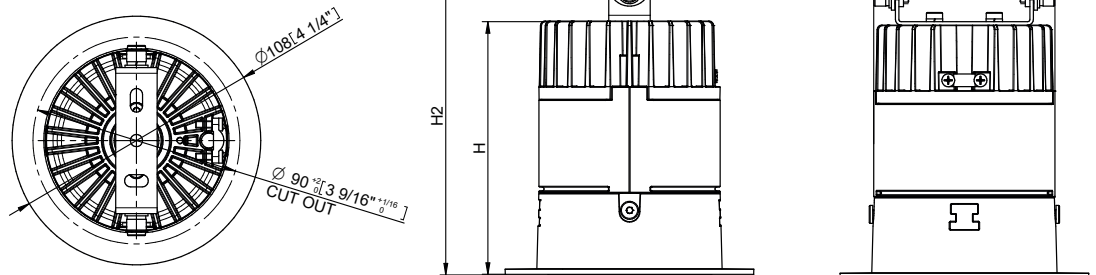

Ambiane SP16 w/Control Unit

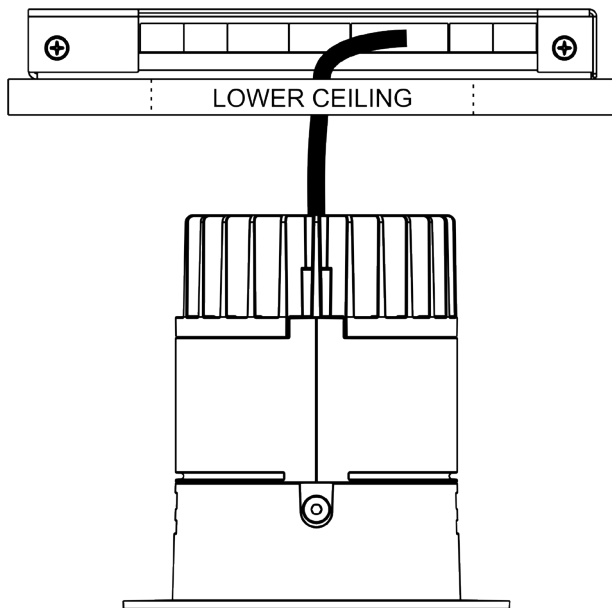

Control Unit dimensions

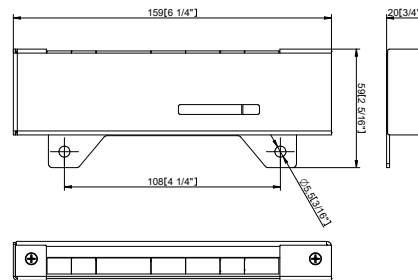

Quad Control Unit dimensions (CE Only)

- to be ordered as a bundle of 4 identical Ambiane SP16 fixtures and one Quad Control Unit.

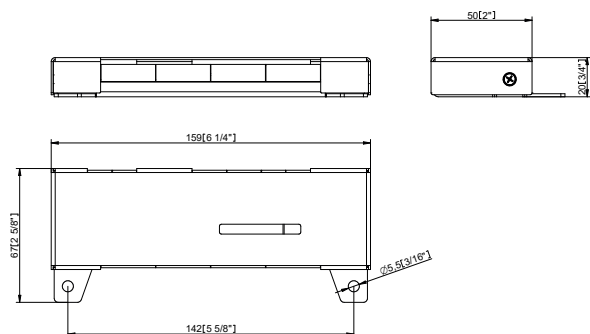

# SPECIFICATION SHEET

## AMBIANE® SP16 RECESSED

Ambiane SP16 Recessed Trimless

30° H = 123 mm [4 8/8" inch]  
 60° H = 113 mm [4 7/16" inch]

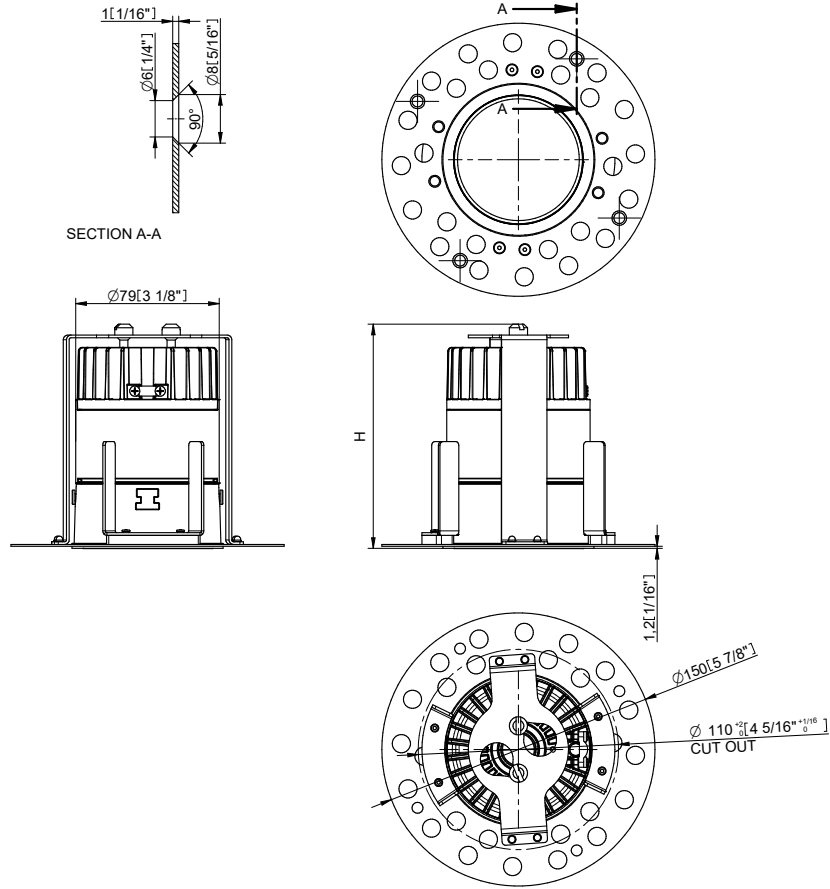

### PHOTOMETRIC DATA

Ambiane SP16 Recessed  
 RGBW 30dg White LEDs only

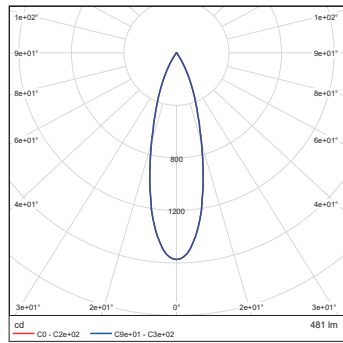

Ambiane SP16 Recessed  
 RGBW 60dg White LEDs

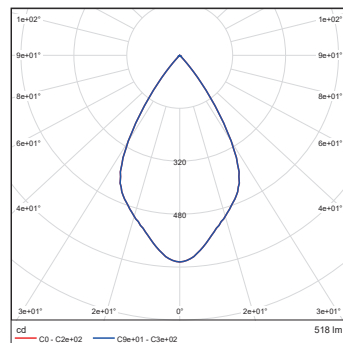

### PHOTOMETRIC OVERVIEW

	Lumen Output (lm)	
	30°	60°
<b>RGBNW (4000 K) WHITE LEDS ONLY</b>	481	518

