

CALUMMA™ M SC

Featuring an optical design using 37 high efficacy single-chip LEDs and available with optional LED colour variants and various beam angles, the medium-sized Calumma M SC luminaire creates powerful and beautiful light output for a spot, accent or flood lighting solution. Its durable housing is built to withstand any exterior conditions, and its special finish for harsh and marine environments provides an exceptional outdoor LED luminaire in an elegant design. Additionally, Calumma M SC can be connected in long In/Out daisy-chains via an E-Box and hybrid Plug & Play connections for almost effortless installation. Complemented by wide range of accessories and control protocols, this luminaire is an effective and versatile unit to get the most out of architectural lighting applications.



KEY FEATURES

Lumen output & Light source

Luminaire with 37 high-power, singlechip LEDs provides up to 3478 lumen output. Multiple LED colour variants. No light spills. Well homogenised light output with great efficacy up to 57 lm/w.

Design & Durability

Compact, durable and stylish housing made of high-pressure die cast aluminium. IP67 and IK10 certification; suitable for marine applications (Harsh Environment Finish required) and traffic applications. Supported with a 5 year warranty.





Flexibility

Exceptional outdoor or indoor LED luminaire with a wide range of accessories, custom colour finishes, multiple light output variants and beam angles.

Connectivity







Utilising the innovative E-Box series of power and data interfaces, Calumma M SC can communicate via numerous wired, wireless, and Ethernet based control protocols. Various wiring topologies are supported using hybrid power / data cables with Plug & Play connectors or standard connection options.

CONTROL & PROTOCOLS













 DMX RDM OPTIONAL	 WIRELESS DMX OPTIONAL	 VIA E-BOX OPTIONAL	 DALI OPTIONAL
 ON OFF PW & SINGLE COLOR ONLY			

OPTIC OPTIONS

SYMMETRICAL









 10°	 15°	 25°	 30°
 45°	 65°	 100°	

BI-SYMMETRICAL

 10°x30°	 10°x60°	 15°x45°	 15°x90°
 30°x60°	 30°x90°	 30°x10°	 60°x10°
 45°x15°	 90°x15°	 60°x30°	 90°x30°

COLOUR TEMPERATURE

* UPON REQUEST





 2.200 K *	 2.500 K *	 2.700 K *	 3.000 K
 3.500 K *	 4.000 K *	 5.000 K *	 6.500 K *
 2.700 K - 6.500 K *			

COLOURS









* UPON REQUEST

 RGBW	 RGBA	 Pure White	 Tuneable White *
-----------------------------------------------------------------------------------------------	-----------------------------------------------------------------------------------------------	-----------------------------------------------------------------------------------------------------	-----------------------------------------------------------------------------------------------------------

FINISH OPTIONS

 Graphite Black	 Silver	 RAL Custom Paint Colour	 Harsh Environment
---------------------------------------------------------------------------------------------------------	-------------------------------------------------------------------------------------------------	------------------------------------------------------------------------------------------------------------------	------------------------------------------------------------------------------------------------------------

STANDARD & SPECIFICATION

 IP67	 IK10	 CE	 ETL
 ROHS	 UK CA	 5 YEAR Warranty with Registration	 Vibration Standard for Bridge

SPECIFICATION

ELECTRICAL	Input Voltage	120 - 277 V AC 50/60 Hz (US)	
	Typical Power Consumption	60 W +/-10 %	
OPTICAL	Light Source	37x High Power Single Chip LEDs	
	Colour Variants	RGBW (W - 6500 K) RGBA PW (W - 3000 K) Other Variants On Request (TW (2700 - 6500 K), 2200 K, 2500 K, 2700 K, 3500 K, 4000 K, 5000 K, 6500 K)	
	Beam Angle	10° 15° 25° 30° 45° 65° 100° 10°x30° 30°x10° 10°x60° 60°x10° 15°x45° 45°x 15° 15°x90° 90°x15° 30°x60° 60°x30° 30°x90° 90°x30°	
	Lumen Output Delivered	3478 lm (@10° RGBW)	
	Projected Lumen Maintenance	L90B10 >90.000 hrs, Ta = 25°C / 77°F	
CONTROL	Interface Protocol	Via E-box range, DMX/RDM, wireless DMX, DALI 2 or ON/OFF (PW & single color only)	
	E-box control protocol	USITT DMX512+RDM, ArtNet, MA Net, MA Net2, sACN, Kling-Net	
	DALI 2 Device Type	DT 8	
	Wireless DMX (Option)	Lumen Radio CRMX Technology	
	Control System	Third Party DMX Controllers or third party DALI 2 controllers, Ethernet	
	Operating Modes	DMX, Stand-alone	
	Settings / Addressing	E-Box, RDM communicator	
	Power Supply	Integrated	
PHYSICAL	Width x Height x Depth	264 x 278 x 106 mm (10.4 x 10.94 x 4.17 in.)	
	Weight	5.9 kg 13 lbs	
	Housing	High Pressure Die-Cast Aluminium Body Tempered Glass	
	Finish Options	Standard Colour - Graphite Black (RAL 9011) Silver (RAL 9006) Cost Option - Custom RAL Harsh Environment (RAL 9016, RAL 9011)	
	Cables / Connections	IN/OUT (for E- Box version): - 0,5 m cables with hybrid connectors - Jumper cables	IN (for DMX, DALI, ON/OFF): - 1 m cable with bare end - Other cable length - custom - Junction box - optional
	Mounting Method	Yoke or Yoke for Pole Adaptor	
	Adjustability	+180° / -180°	
	Protection Factor	IP67 / Suitable For Wet Locations	
	IK Rating	IK10	
	Cooling System	Convection	
Operating Ambient Temperature	-20 °C / +50 °C (-4 °F / +122 °F)		
CERTIFICATION	Listings	ETL / cETL, CE, RoHS, UKCA	
ACCESSORIES	Not Included Items		
		Junction Box for Calumma	
		Optical Demo Set for Calumma M	
		Top Hat Calumma M	
		Half Top Hat Calumma M	
		Tenon Adaptor for Calumma M	
		Floor Stand for Calumma S, M Pole Adaptor (ø 102mm) (Yoke for Pole Adaptor Required)	

PROJECTED AREA

	Front (rear) - m ²	Front (rear) ft ²	Side - m ²	Side - ft ²	Top - m ²	Top - ft ²
Calumma Remote M	0,047	0,500	0,026	0,280	0,024	0,258
with Top Hat	0,047	0,500	0,054	0,581	0,052	0,559
with Half Top Hat	0,047	0,500	0,037	0,398	0,052	0,559

DIMENSIONS

Standard Yoke

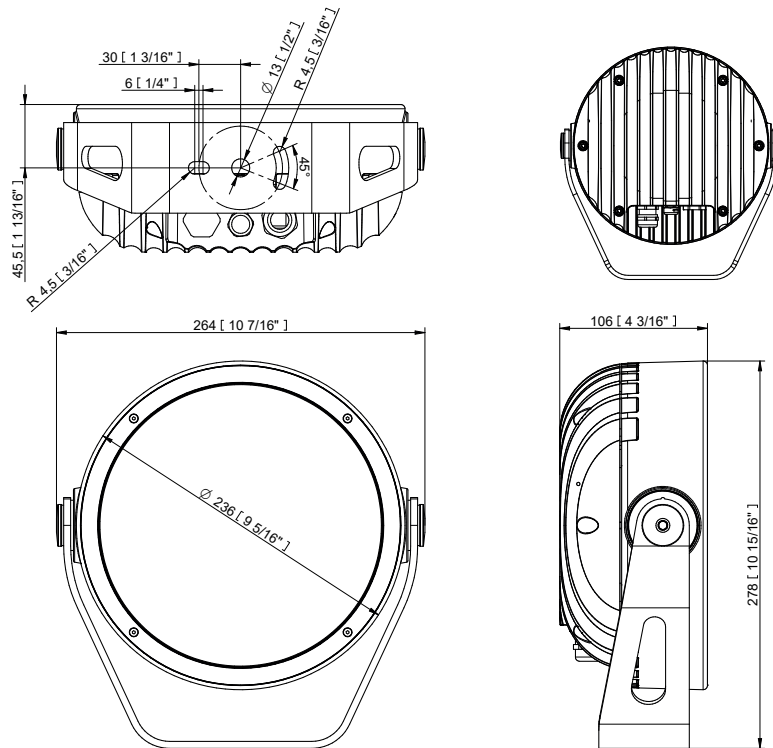

Yoke for Pole Adaptor (with Pole Adaptor / PA)

Example of ordering code: Calumma M SC RGBCW 15° PA

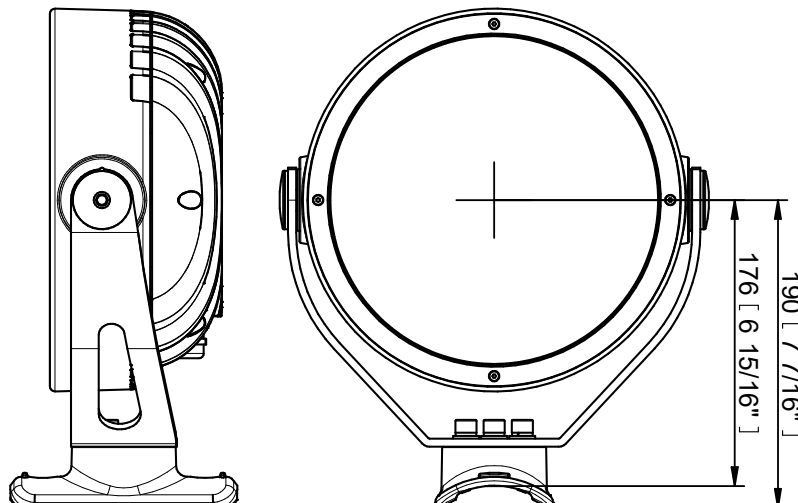

CONTROL AND CONNECTION OPTIONS - CE

DALI

- 1) Hybrid Cable (1305 3693)
Standard 1 m with bare-end
- 2) Hybrid Cable (1305 3693)
or
Scope of Others
- 3) Junction Box for Calumma

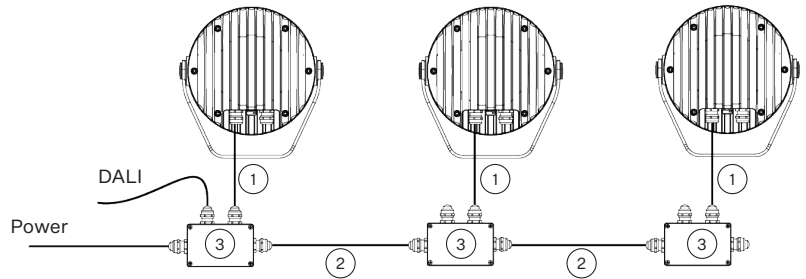

DMX

- 1) Flamar 3x AWG 16 + 1 x (2x AWG 24)
Standard 1 m with bare-end, (13051508), black
or
Hybrid Cable HYB-5731ZH LSZH (13053694), white
- 2) Flamar 3x AWG 16 + 1 x (2x AWG 24), (13051508), black
or
Hybrid Cable HYB-5731ZH LSZH (13053694) white
or
Scope of Others
- 3) Junction Box for Calumma

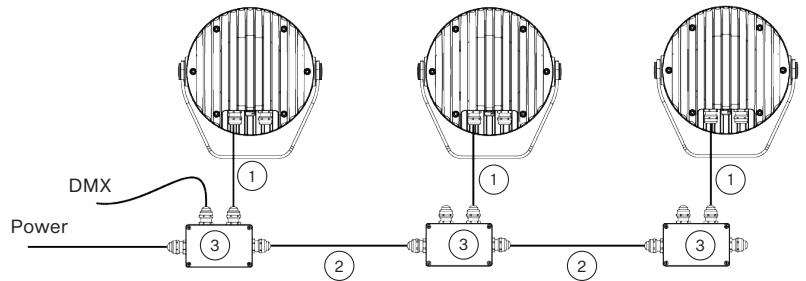

WIRELESS DMX

- 1) Flamar 3x AWG 16 + 1x (2x AWG 24),
(13051508), Standard 1 m bare-end, black
or
Hybrid Cable HYB-5731ZH LSZH (13053694), white
- 2) Junction Box for Calumma

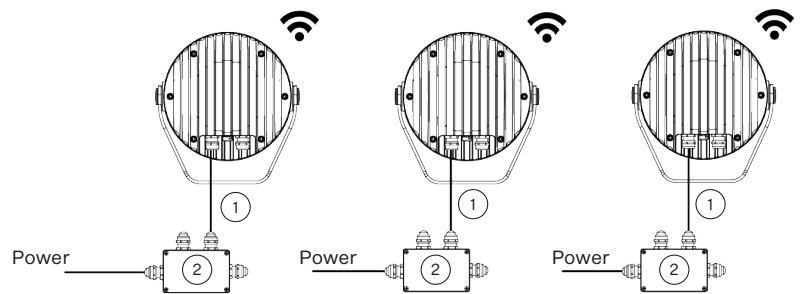

Note: This type of connection is available for M, L, XL versions.

- 1) Flamar 3x AWG 16 + 1x (2x AWG 24)
(13051508), Standard 1 m bare-end, black
or
Hybrid Cable HYB-5731ZH LSZH (13053694), white
- 2) Junction Box for Calumma
- 3) Flamar 3x AWG 16 + 1 x (2x AWG 24), (13051508)
or
Hybrid Cable HYB-5731ZH LSZH (13053694), white
or
Scope of Others

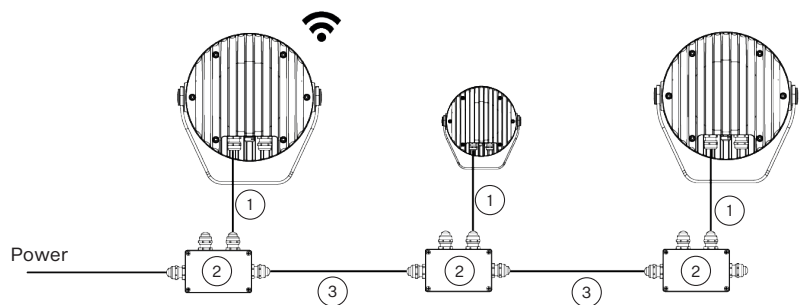

Note: This type of connection must have M, L or XL versions as the first luminaire. Next luminaires in a row could be chosen from S, M, L or XL versions.

CONTROL AND CONNECTION OPTIONS - CE

DMX or ETHERNET via E-BOX

- 1) Flamar 3x AWG 16 + 1x (2x AWG 24) (13051508), Standard 1 m with bare-end, black or Hybrid Cable HYB-5731ZH LSZH (13053694), white
- 2) Junction Box for Calumma
- 3) Flamar 3x AWG 16 + 1x (2x AWG 24), (13051508), black or Hybrid Cable HYB-5731ZH LSZH (13053694) white or Scope of Others

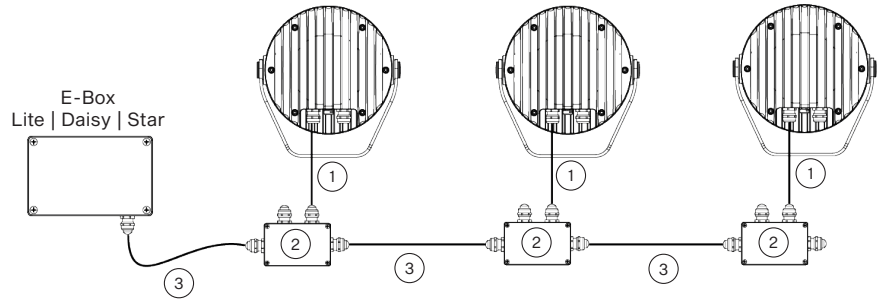

Note: This type of connection is available for S, M, L, and XL versions. E-Box has to be in Pass Through mode only.

- 1) Leader Cable MM (13053493) Standard 0,5 m with hybrid connector
- 2) Leader Cable MF (13053494) Standard 0,5 m with hybrid connector
- 3) Leader Cable FF 2 m (13053438)
Leader Cable FF 5 m (13053440)
Leader Cable FF 10 m (13053436)
Leader Cable FF 25 m (13053437)
Leader Cable FF 50 m (13053439)

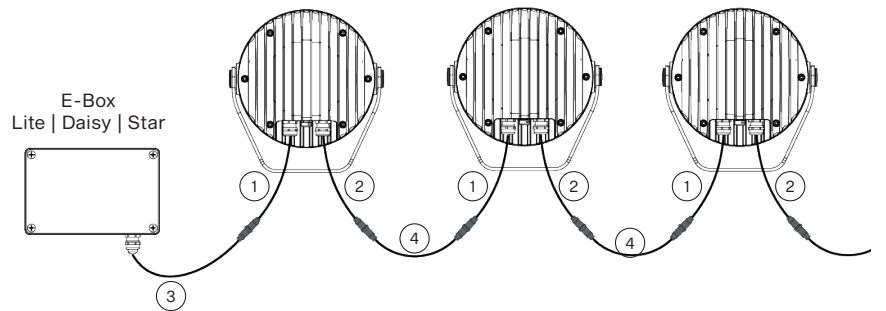

- 4) Jumper Cable FF/FM 0,25 m (13053422)
Jumper Cable FF/FM 0,5 m (13053423)
Jumper Cable FF/FM 1 m (13053425)
Jumper Cable FF/FM 2 m (13053427)
Jumper Cable FF/FM 3 m (13053428)
Jumper Cable FF/FM 5 m (13053430)
Jumper Cable FF/FM 10 m (13053424)

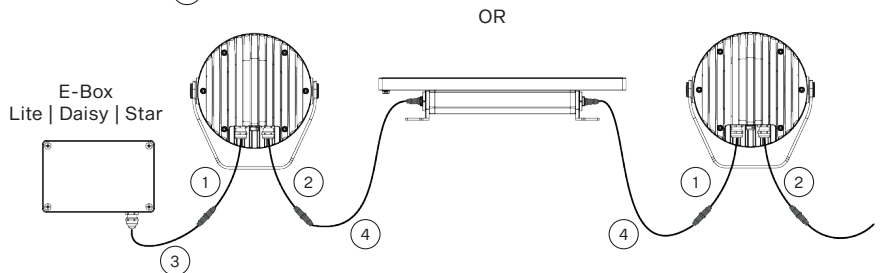

Note: With this type of connection is possible to connect Calumma (M, L, XL) and Eminere (Eminere, Eminere Side) luminaires in a row.

ON/OFF

- 1) 3-cored cable H07BB-F 3G 1.5 (1305 1443), Standard 1 m with bare-end

Note: This type of connection is available for Pure White and single color version only. Non dimmable.

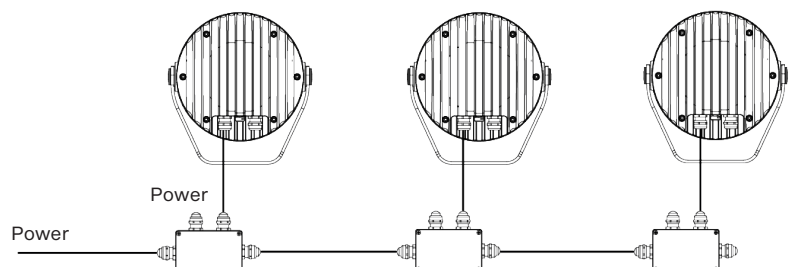

CONTROL AND CONNECTION OPTIONS - US

DALI

- 1) SJTW 5x 14AWG (13053336), Standard 1 m with bare-end, black
or
Cable SJTW 5x 14AWG (13053697), white
- 2) SJTW 5x 14AWG (13053336), black
or
Cable SJTW 5x 14AWG (13053697), white
or
Scope of Others
- 3) Junction Box for Calumma

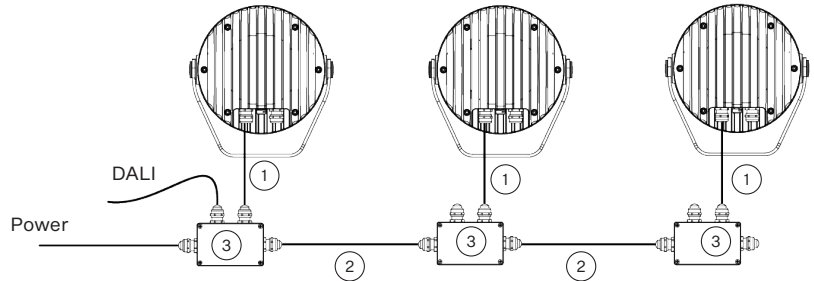

WIRELESS DMX

- 1) SJTW 6x 14AWG (13053480), Standard 1 m with bare-end, black
or
Cable SJTW 6x 14AWG (13053695), white
- 2) Junction Box for Calumma

Note: This type of connection is available for M, L, XL versions

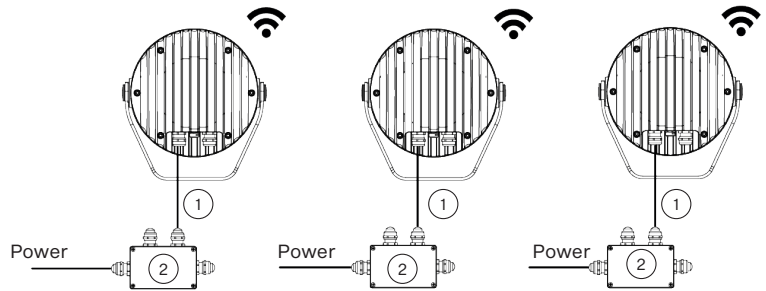

- 1) SJTW 6x 14AWG (13053480), Standard 1 m with bare-end, black
or
Cable SJTW 6x 14AWG (13053695), white
- 2) Junction Box for Calumma
- 3) SJTW 6x 14AWG (13053480), black
or
Cable SJTW 6x 14AWG (13053695), white
or
Scope of Others

Note: This type of connection must have M, L or XL versions as the first luminaire. Next luminaires in a row could be chosen from S, M, L or XL versions.

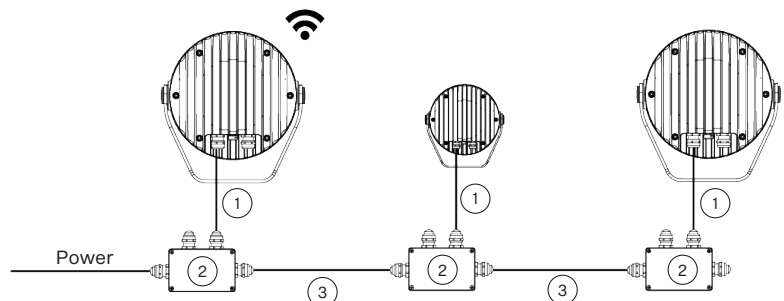

CONTROL AND CONNECTION OPTIONS - US

DMX or ETHERNET via E-BOX

- 1) SJTW 6x 14AWG (13053480)
Standard 1 m with bare-end, black
or
Cable SJTW 6x 14AWG (13053695), white
- 2) Junction Box for Calumma
- 3) SJTW 6x 14AWG (13053480), black
or
Cable SJTW 6x 14AWG (13053695), white
or
Scope of Others

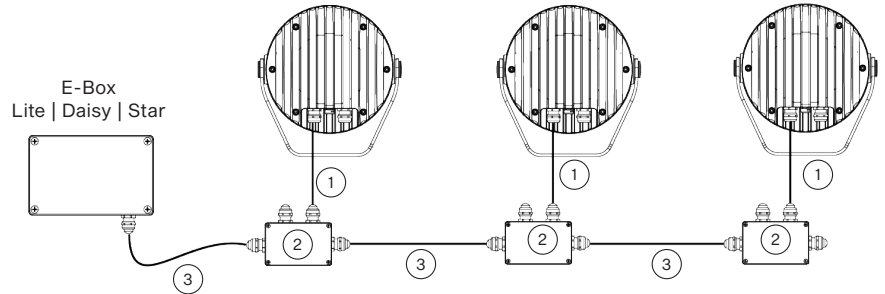

Note: This type of connection is available for S, M, L, and XL versions. E-Box has to be in Pass Through mode only.

ON/OFF

- 1) 3-cored cable SE00W power 3x16 AWG (13051558-01), Standard 1 m with bare-end

Note: This type of connection is available for Pure White and single color version only. Non dimmable.

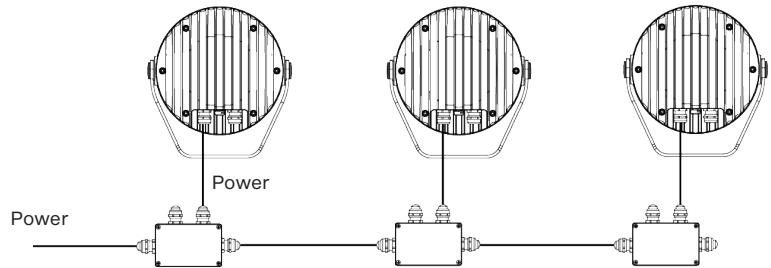

CONNECTIVITY

Following table shows maximum connected Calummas M SC in a row with respect of cable length.

STANDARD MODE	Cable length (m)	Voltage (V)			
		120	190	230	277
CALUMMA M SC	10	30	48	58	70
	20	30	48	58	70
	30	21	48	58	70
	50	13	32	47	68
	70	9	23	34	49
	100	6	16	24	34
	200	3	8	12	17
	500	1	3	5	7

PASS-THROUGH MODE	Cable length (m)	Voltage (V)			
		120	190	230	277
CALUMMA M SC	10	30	32	32	32
	20	30	32	32	32
	30	21	32	32	32
	50	13	32	32	32
	70	9	23	32	32
	100	6	16	24	32

BOOSTER BOX POSITIONS

Cable length (m)		Max. number of Calummas M SC= 191 (in Standard mode)			
		120 V	190 V	230 V	277 V
CALUMMA M SC	10 m	30	-	-	-
	20 m	30, 60	48	58	70
	30 m	21, 42, 63, 84, 105, ...	48, 96	58	70
	50 m	13, 26, 39, 52, 65, 78, 91...	32, 64, 96, 128, 158, 180...	47, 94, 141, 188...	68, 136
	70 m	9, 18, 27, 36, 45, 54, 63....	23, 46, 69, 92, 115...	34, 68, 102, 136...	49, 98, 147, 196..
	100 m	16, 12, 18, 24, 30, 36, 42, 48, 54, 60, 66, 72, 78, 84, 90, 96, 102....	16, 32, 48, 64, 80, 96, 112, 128, 144...	24, 48, 72, 96, 120...	34, 68, 102, 136...
	200 m	3, 6, 9, 12, 15, 18, 21, 24, 27, 30, 33, 36, 39, 42, 45, 48, 51, 54, 57, 60, 63, 66, 69, 72, 75, 78, 81...	8, 16, 24, 32, 40, 48, 56, 64, 72, 80, 88, 96....	12, 24, 48, 56, 64, 76, 88, 100...	17, 34, 51, 68, 85, 102
	500 m	1, 2, 3, 4, 5, 6, 7, 8, 9, 10, 11....	3, 6, 9, 12, 15, 18, 21, 24, 27, 30, 33, 36, 39, 42, 45, 48....	5, 10, 15, 20, 25, 30, 35, 40...	7, 14, 21, 28, 35, 42, 49, 56, 63, 70, 77...

NOTE: For more detail see the User manual.

ACCESSORIES

Top Hat

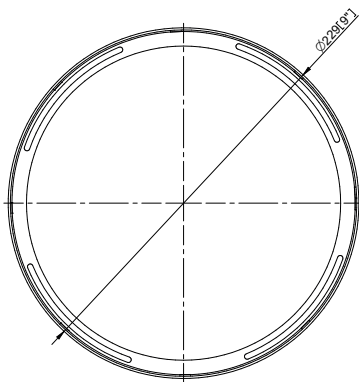

Half Top Hat

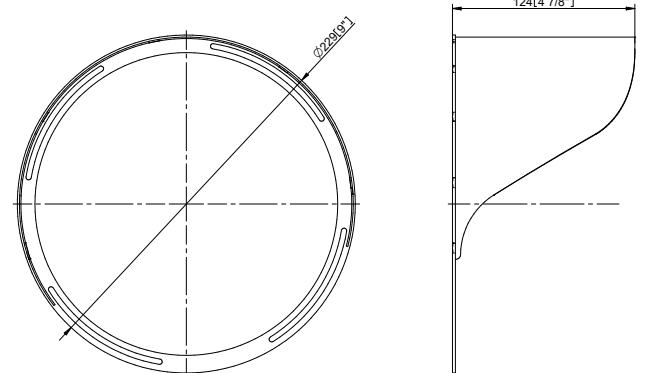

Floor Stand

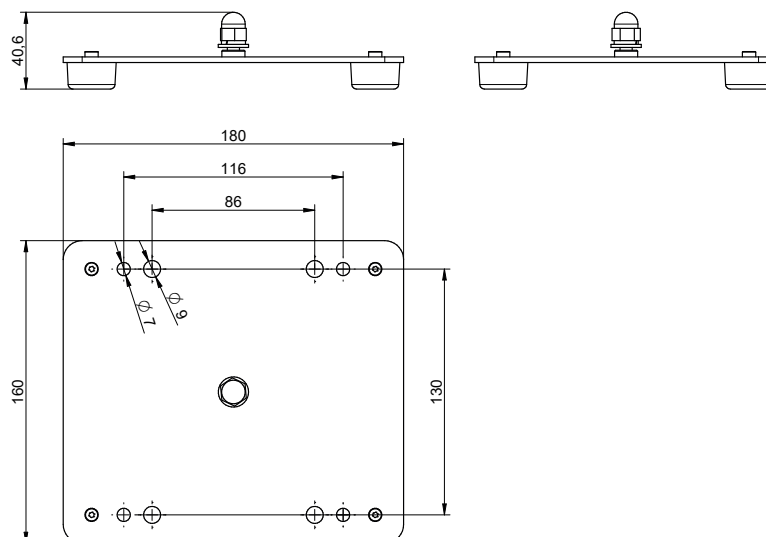

Pole Adaptor (ø 102mm)

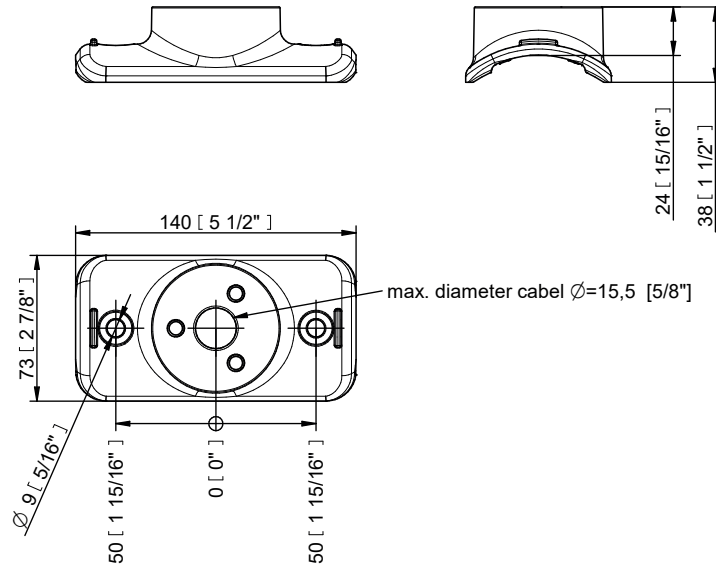

PHOTOMETRIC OVERVIEW

Lumen Output (lm)

	RGBCW (W 6500 K)	RGBA	WW (W 3000 K)
10°	3478	2439	4305
15°	3169	2222	3923
25°	3097	2172	3834
30°	3040	2132	3763
45°	3104	2177	3842
65°	3043	2134	3767
100°	3081	2160	3814
10° x 30°, 30° x 10°	3060	2146	3788
10° x 60°, 60° x 10°	3045	2135	3769
15° x 45°, 45° x 15°	3177	2228	3933
30° x 60°, 60° x 30°	3027	2123	3747
30° x 90°, 90° x 30°	2853	2001	3532
15° x 90°, 90° x 15°	2996	2101	3709

BI-SYMMETRICAL BEAM ANGLES

Bi-symmetrical:
10°x30°,
10°x60°,
15°x45°,
15°x90°,
30°x60°,
30°x90°

10°, 15°, 30°

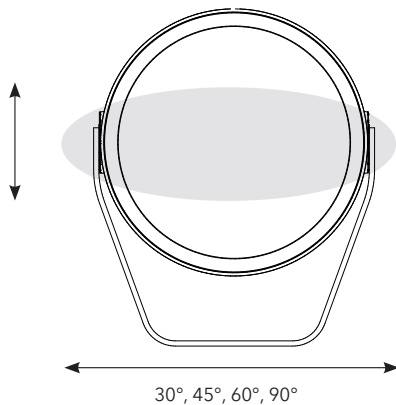

Bi-symmetrical:
30°x10°,
60°x10°,
45°x15°,
90°x15°,
60°x30°,
90°x30°

30°, 45°, 60°, 90°

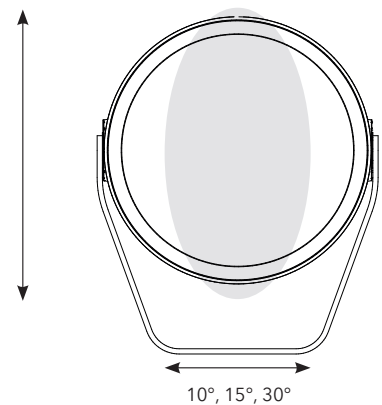

PHOTOMETRIC DATA

Calumma M SC RGBW 6500K 10dg

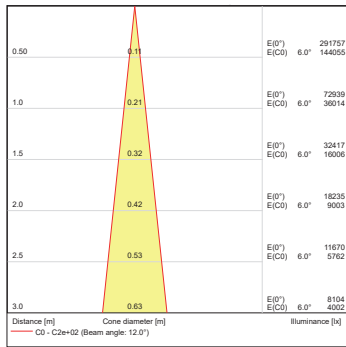
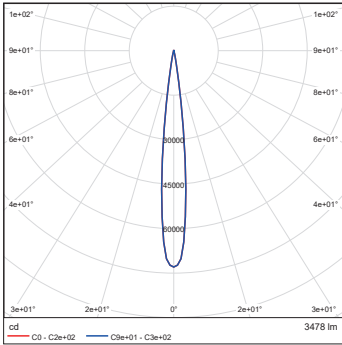

Calumma M SC RGBW 6500K 15dg

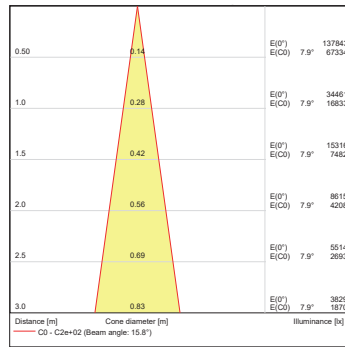
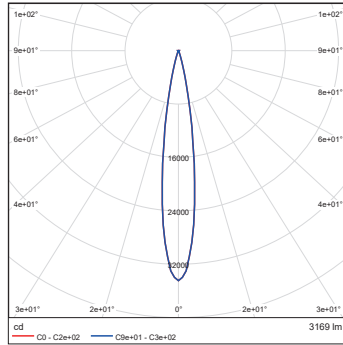

Calumma M SC RGBW 6500K 25dg

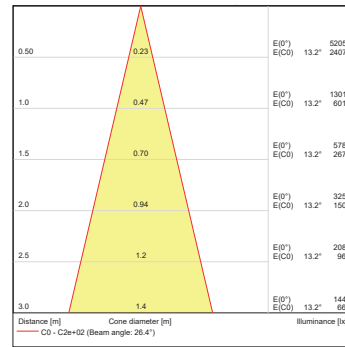
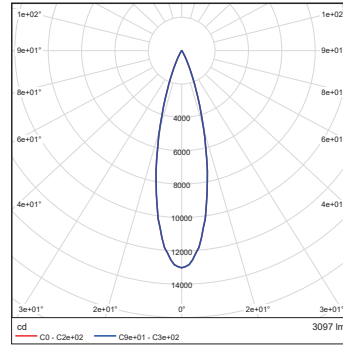

Calumma M SC RGBW 6500K 30dg

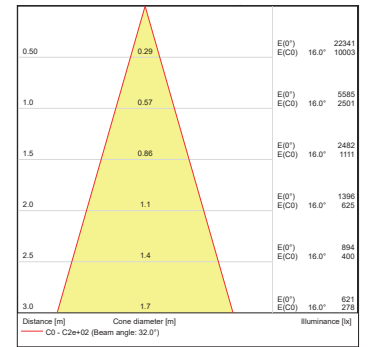
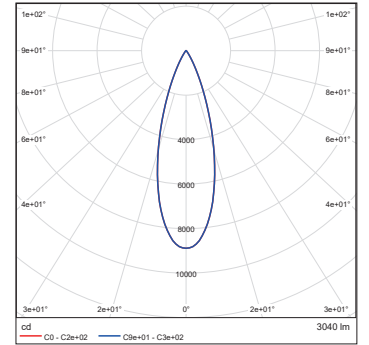

Calumma M SC RGBW 6500K 45dg

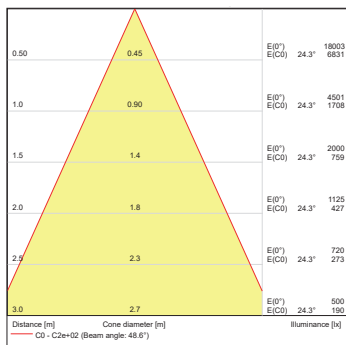
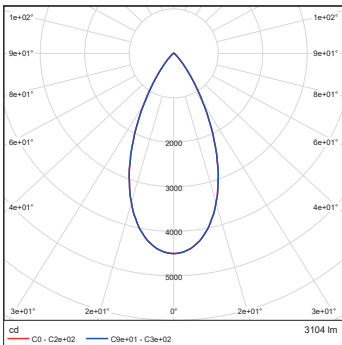

Calumma M SC RGBW 6500K 65dg

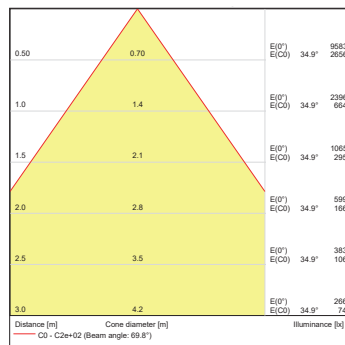
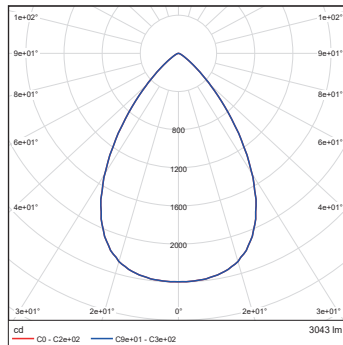

Calumma M SC RGBW 6500K 100dg

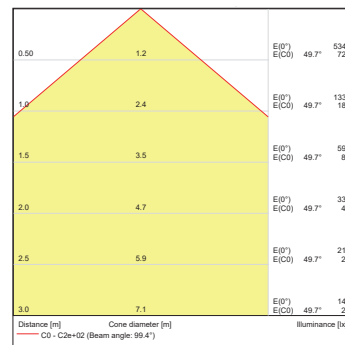
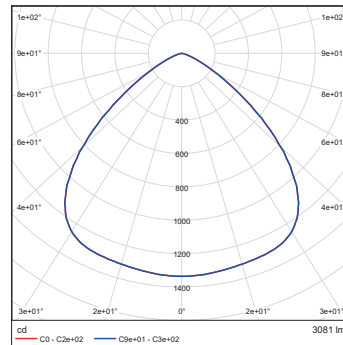

PHOTOMETRIC DATA

Calumma M SC RGBW 6500K
10x30dg

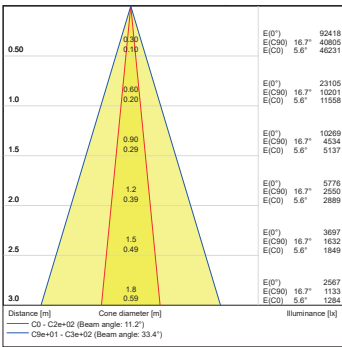
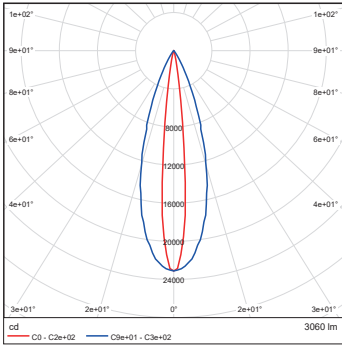

Calumma M SC RGBW 6500K
10x60dg

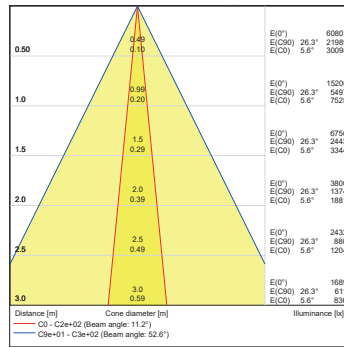
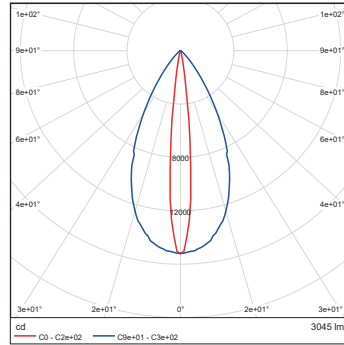

Calumma M SC RGBW 6500K
15x45dg

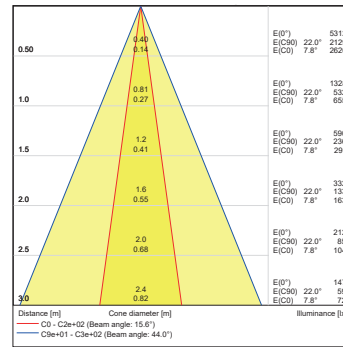
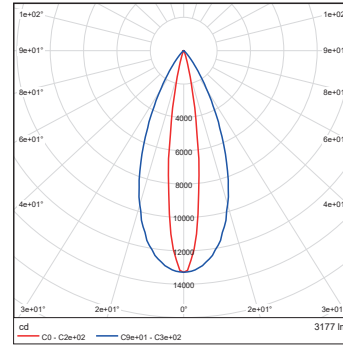

Calumma M SC RGBW 6500K
15x90dg

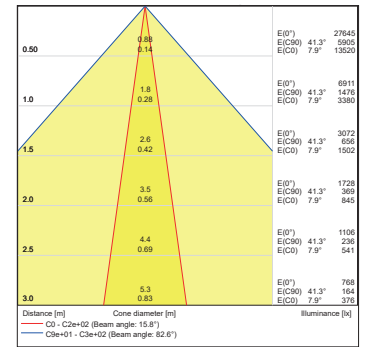
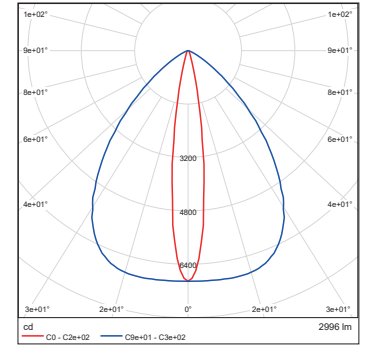

Calumma M SC RGBW 6500K
30x60dg

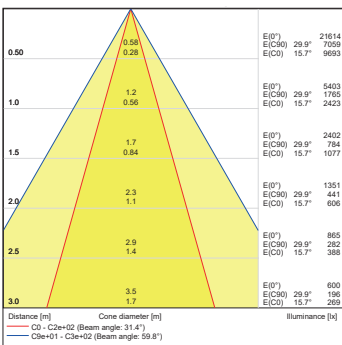
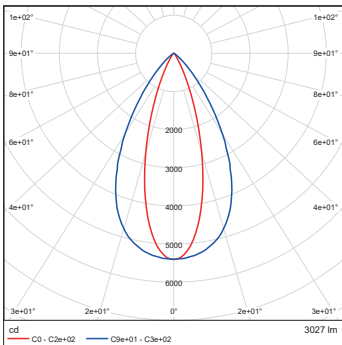

Calumma M SC RGBW 6500K
30x90dg

