

# DIVINE™ 72

The latest fixture in the Divine range, the Divine 72™ features cutting-edge Zero Passive™ technology to eliminate light over-spill with our most precise optics to date. Specifically developed to optimise the beam for long throw applications, the native 6° beam angle delivers an impressive 6.573 lx at 10 meters. Backed by a 5 year warranty and an IP67 rating, this unit has been designed for the rigours of extreme weather, and with flexible mounting options and accessories it can be installed on the most demanding projects.



## KEY FEATURES

Optimised for long throw applications, patented beam control technology eliminates light spill.

### Lumen Output & Light Source

Up to 10,228 lm delivered (RGBW at 6° 6500 K)  
72 x High Power LEDs

### Projected Lumen Maintenance

Long LED life over 60,000 hrs (L70@25°C)

### Power Consumption

Typical power consumption 325W

## CONTROL & PROTOCOLS

 DMX & RDM	 0-10V PURE WHITE ONLY	 WIRELESS DMX OPTIONAL
--	--	--

## STANDARD & SPECIFICATION

 IP67	 IK10	 CE	 ETL US	 RoHS	 2 Year Warranty	 5 Year Warranty (Registered)
---	---	---	--	---	---	---

## COLOURS

\* UPON REQUEST  
(AVAILABLE Q3/2021)

 RGBW	 Pure White *	 Tuneable White *
--	--	--

## COLOUR TEMPERATURES

\* UPON REQUEST  
(AVAILABLE Q3/2021)







 2.700 K *	 6.500 K *	 2.700 K - 6.500 K *
--	--	--

## FINISH OPTIONS







 RAL 9011 Graphite Black	 RAL 9006 Silver	 Custom Paint Colour
--	---	---

## OPTIC OPTIONS

### SYMMETRICAL

 6°	 13°	 20°	 30°	 40°	 60°	 90°
--	--	--	--	--	--	--

### BI-SYMMETRICAL

 6x30°	 6x60°	 10x40°	 10x90°	 35x70°	 30x90°
---	--	---	---	---	---

**DIVINE 72 SPECIFICATION**

<b>ELECTRICAL</b>	Input Voltage	100 - 277 V AC 50/60 Hz	
	Typical Power Consumption	325 W +/- 10 % (for RGBW and PW 6500K variant)	300 W +/- 10 % (for TW and WW 2700K variant)
	Inrush Current	30 A @ 230 V, 20 A @ 115V	
<b>OPTICAL</b>	Light Source	72 x High Power Single Chip LEDs	
	Colour Variants	RGBW (W - 6500 K)	TW (2700 - 6500 K) Upon Request   PW (2700 K, 6500 K) Upon Request
	Beam Angle	Symmetrical: 6°   10°   20°   30°   45°   60°   100° Bi-symmetrical: 6° x 30°   30° x 6°   6° x 60°   60° x 6°   10° x 40°   40° x 10°   35° x 70°   70° x 35°   30° x 90°   90° x 30°   10° x 90°   90° x 10°	
	CRI	70+ (@RGBCW and PW 6500 K)	80+ (@PW 2700 K)
	Peak Intensity	6.573 lx @ 10 m	
	Lumen Output Delivered	10.228 lm (RGBW 6°, all LEDs on full)	
	Projected Lumen Maintenance	60.000 hrs (L70 @ 77 °F / 25 °C)	
<b>CONTROL</b>	Display	LED Display (Inside Integrated Junction Box) Chassis Mounted LED Display (Optional)	
	Wireless DMX (Option)	Lumen Radio CRMX Technology	
	Interface Protocol	USITT DMX512, RDM, 0-10 V	
	Control System	Third Party DMX Controllers	
	Operating Modes	DMX, Stand-alone	
	DMX Modes	4	
	DMX Channels	10, 14, 5, 4	
	Programs / Functions / Features	Editable Program: 1 (up to 40 steps)	
	Settings / Addressing	Via LED Display with Control Buttons or RDM	
	Power Supply	Integrated	
<b>PHYSICAL</b>	Width x Height x Depth	463 x 314 x 175 / 237 mm (18.2 x 12.4 x 6.9 / 9.3 in.)	
	Weight	16.8 kg / 37 lbs	
	Housing	High Pressure Die-Cast Aluminium Body Tempered Glass	
	Finish Options	Standard Colour - Graphite Black (RAL 9011), Silver (RAL 9006) Cost Option - Custom RAL	
	Cables / Connections	Integrated Junction Box With Terminal Block Recommended: Li9Y11Y 3 x AWG16 + 1(2 x AWG24)	
	Mounting Method	Surface Mount, Flush (J-Box), C-Clamp (For Side Connection Only)	
	Adjustability	+35° / -90°	
	Protection Factor	IP67 / Suitable For Wet Locations	
	IK Rating	IK10	
	Cooling System	Convection	
	Operating Ambient Temperature	-20 °C / +40 °C (-4 °F / +104 °F)	
	Operating Temperature	+85°C @ Ambient + 25°C (+185°F @ Ambient + 77°F)	
	Total Heat Dissipation	1410 BTU/h (calculated)	
<b>CERTIFICATION</b>	Listings	ETL / cETL, CE, RoHS	
<b>ACCESSORIES</b>		Surface Mount Adaptor (Included)	
		Optical Demo Set for Divine 72	
		Set of Rubber Feet	
		C-Clamp Adaptor Divine (for side conn. only)	
		Single Top Loader Case Divine	

**DIMENSIONS**

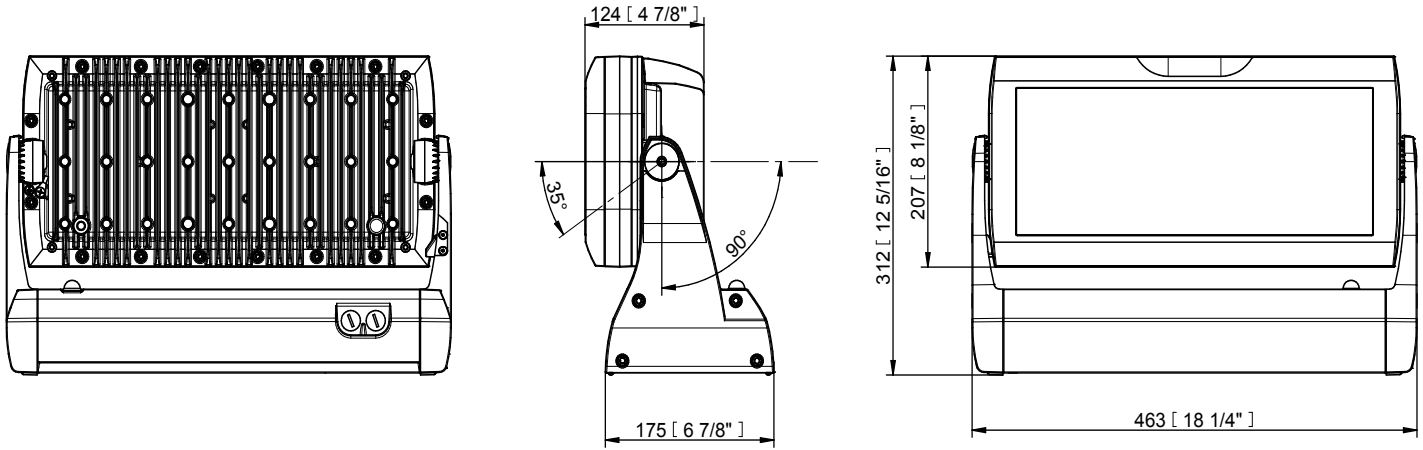

**PHOTOMETRIC OVERVIEW**

	Lumen Output (lm)		
	RGBW (6500 K)	TW (W 2700 - 6500 K)	CW (W 6500 K)
6°	10 228	11 142	20 441
10°	9 288	10 978	20 140
20°	8 603	10 168	18 654
30°	8 061	9 528	17 480
45°	8 539	10 093	18 516
60°	8 913	10 534	19 325
100°	8 638	10 210	18 731
6° x 30°, 30° x 6°	8 350	9 869	18 105
6° x 60°, 60° x 6°	7 837	9 263	16 994
10° x 40°, 40° x 10°	8 025	9 485	17 401
10° x 90°, 90° x 10°	7 199	8 509	15 610
30° x 90°, 90° x 30°	8 536	10 089	18 509
35° x 70°, 70° x 35°	8 758	10 352	18 991

**ACCESSORIES FOR DIVINE 72**

C-Clamp Adaptor Divine (for side conn. only)

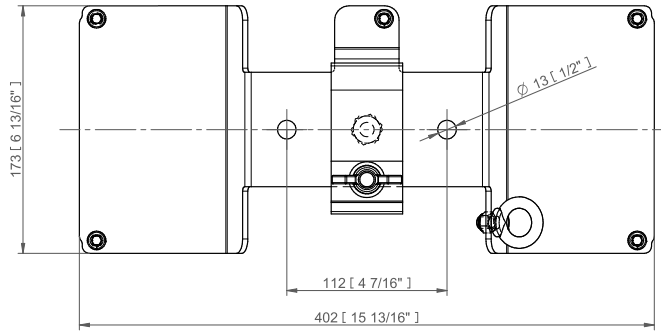
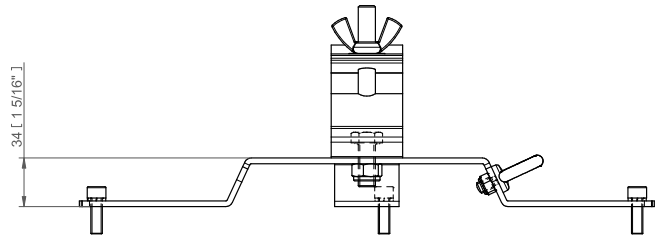
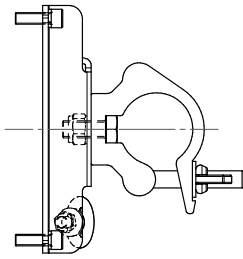
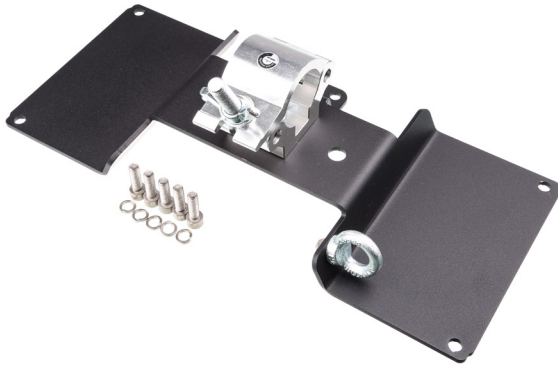

Set of Rubber Feet

