

EMINERE™ SIDE 1 / 2 / 3 / 4

Eminere™ Side is specifically designed for applications where a low form factor is required keeping installation of the luminaire neat and clean. The new Eminere™ range by Anolis builds on the success of the original ArcLine™ Outdoor with precision optics and is available in a variety of sizes, perfect for a wide range of exterior and interior applications such as Flood Lighting, Wall Grazing, Wall Washing and Accent Lighting. Built to exacting standards, these IP67 rated linear fixtures are tough enough to withstand extreme environments whilst producing beautiful colours from the RGBW, RGBA or PureWhite LED chips.



KEY FEATURES

Complete solution for illuminating buildings, monuments, walls, statues, bridges, coves and arches and much more.

Wide range of optics allowing to place product anywhere is needed with no limitation.

Full spectral LEDs selection with custom option on request.

High durability of IK06 in combination of ingress factor IP67.

Easy and quick installation using click on connectors overmolded on combo cable (Power + Data).

CONTROL & PROTOCOLS



OPTIONAL



OPTIONAL

STANDARD & SPECIFICATION



Vibration Standard for Bridge



5 Year Warranty

COLOURS



RGBW

RGBA

Pure White

Tuneable White

COLOUR TEMPERATURE

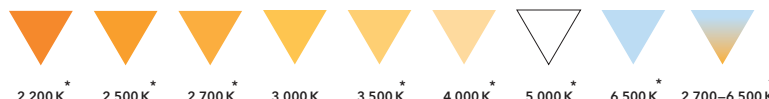

2.200 K*

2.500 K*

2.700 K*

3.000 K*

3.500 K*

4.000 K*

5.000 K*

6.500 K*

2.700-6.500 K*

* UPON REQUEST

FINISH OPTIONS

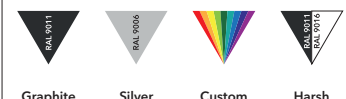

Graphite Black

Silver

Custom Paint Colour

Harsh Environment

OPTIC OPTIONS

SYMMETRICAL



9°

15°

30°

50°

65°

100°

ASYMMETRICAL



WIDE WALLWASHER

WALLWASHER

BI-SYMMETRICAL



10x30°

10x60°

15x90°

35x70°

30x10°

60x10°

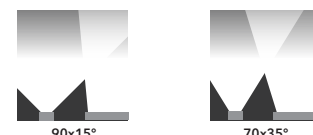

90x15°

70x35°

EMINERE SIDE SPECIFICATION

ELECTRICAL	Input Voltage	120 - 277 V AC 50/60 Hz			
	Typical Power Consumption	Eminere Side 1		25 W	
		Eminere Side 2		45 W	
		Eminere Side 3		65 W	
Eminere Side 4		85 W			
OPTICAL	Light Source	12, 24, 36, 48 x High Power Single Chip LEDs			
	Colour Variants	RGBW (W - 6.500 K)		RGBA	PW (W - 3.000 K)
		Variants On Request (TW (2700 - 6500 K), 2.200 K 2.500 K 2.700 K 3.500 K 4.000 K 5.000 K 6.500 K)			
	Beam Angle	Symmetrical:	9° 15° 30° 50° 65° 100°		
		Bi-symmetrical:	10° x 30° 30° x 10° 10° x 60° 60° x 10° 35° x 70° 70° x 35° 15° x 90° 90° x 15°		
		Asymmetrical:	Wallwasher Wide Wallwasher		
	Lumen Output Delivered	Eminere Side 1		1.147 lm, RGBW @ 9°	
		Eminere Side 2		2.294 lm, RGBW @ 9°	
Eminere Side 3		3.441 lm, RGBW @ 9°			
Eminere Side 4		4.588 lm, RGBW @ 9°			
Projected Lumen Maintenance	60.000 hrs (L70 @ 25 °C / 77 °F)				
CONTROL	Interface Protocol	Via E-Box range or Wireless DMX (excluded Eminere Side 1)			
	E-Box Control Protocols	USITT DMX512, RDM, ArtNet, MA Net, MA Net2, sACN, Kling-Net			
	Wireless DMX (Option)	Lumen Radio CRMX Technology			
	Operating Modes	Pixel (12 LEDs/300mm) or Fixture mode			
	Setting / Addressing	Via Two Row LCD Display with Control Buttons or RDM communicator			
	Power Supply	Integrated			
	Connectivity	E-box Lite		144 of Eminere Side 1 (@ 230 V and 40m cable) via 1 Output	
E-box Daisy		144 of Eminere Side 1 (@ 230 V and 40m cable) via 1 Output			
E-box Star		144 of Eminere Side 1 (@ 230 V and 40m cable) via 6 Outputs			
PHYSICAL	Width x Height x Length	Eminere Side 1		148 x 76 x 329 mm (5.82 x 2.99 x 12.95 in.)	
		Eminere Side 2		148 x 76 x 629 mm (5.82 x 2.99 x 24.76 in.)	
		Eminere Side 3		148 x 76 x 929 mm (5.82 x 2.99 x 36.57 in.)	
		Eminere Side 4		148 x 76 x 1229 mm (5.82 x 2.99 x 48.38 in.)	
	Weight	2.95 kg / 6.5 lbs	4.75 kg / 10.47 lbs	7 kg / 15.43 lbs	8.92 kg / 19.67 lbs
	Housing	High Pressure Extruded Aluminium Body End Caps - Die-Cast Aluminium Tempered Glass			
	Finish Options	Standard Colour		Graphite Black (RAL 9011) Silver (RAL 9006)	
		Cost Option		Custom RAL Harsh Environment (RAL 9016, RAL 9011)	
	Cables / Connections	IP67 Hybrid Connection (Power + Data)			
	Mounting Method	Surface Mount With Different Type of Brackets			
	Adjustability	-105° / +15°			
	Protection Factor	IP67 / Suitable For Wet Locations			
	IK Rating	IK06			
	Cooling System	Convection			
Operating Ambient Temperature	-20 °C / +40 °C (-4 °F / +104 °F)				
Operating Temperature	+67 °C @ Ambient +40 °C (+153 °F @ Ambient +104 °F)				
CERTIFICATION	Listings	ETL / cETL, CE, RoHS			

EMINERE SIDE SPECIFICATION

ACCESSORIES	Mounting Brackets	Mounting Brackets 50 100 200 300 mm	
		Mounting Brackets - custom length	
	Shields	Shield For Eminere Side 1 2 3 4	
	Cables and Connectors	Field Installable Connector FF	
		Field Installable Connector FM	
		Cable CE WCA Cable US WCA	
		Waterproof Cover Cap FM ZAHB-0006	
		CE/UL Leader Cables FF for Eminere:	Leader Cable FF 2 5 10 25 50m
	CE/UL Jumper Cables FF/FM for Eminere:	Jumper Cable FF/FM 0,25 0,5 1 2 3 5 10m	
Booster Box	Booster Box		

DIMENSIONS

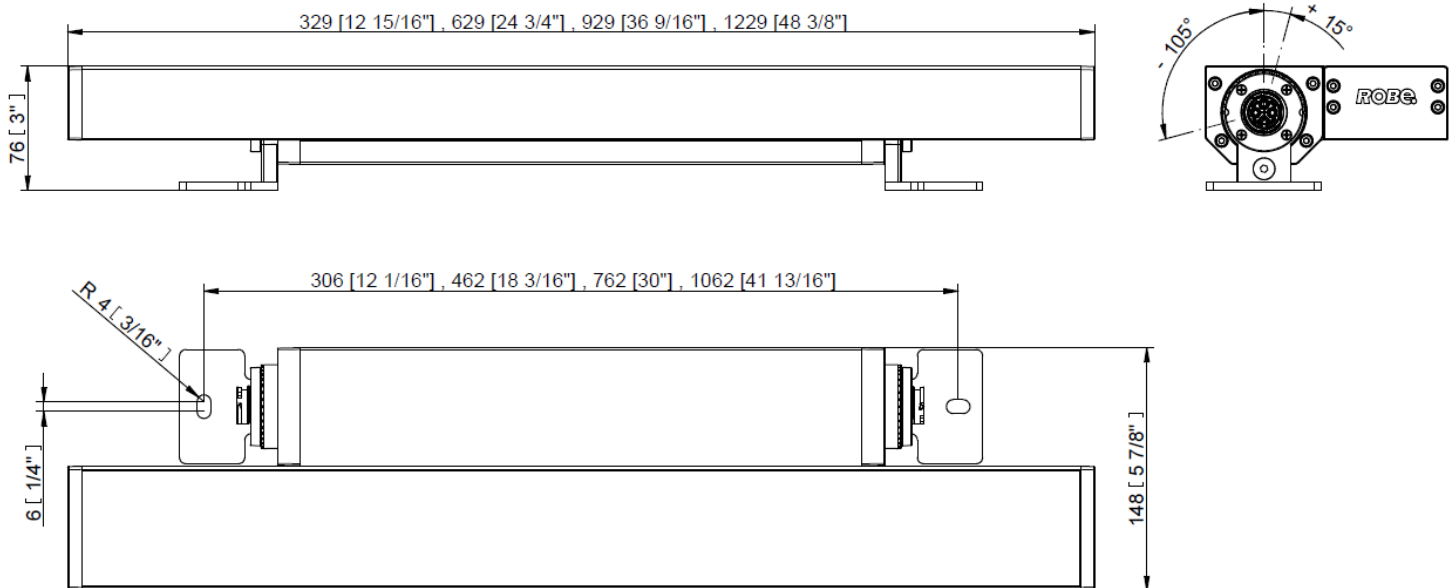

BI-SYMMETRICAL BEAM ANGLES

Bi-symmetrical: 10°x30°, 10°x60°, 35°x70°, 15°x90°

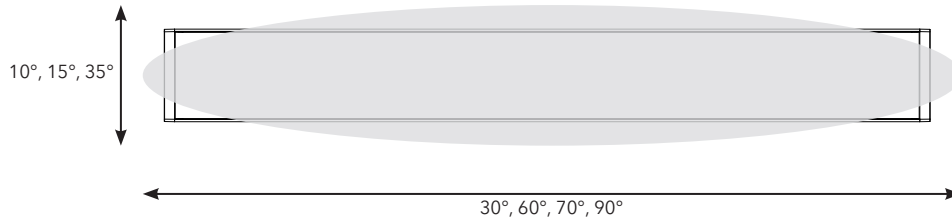

Bi-symmetrical: 30°x10°, 60°x10°, 70°x35°, 90°x15°

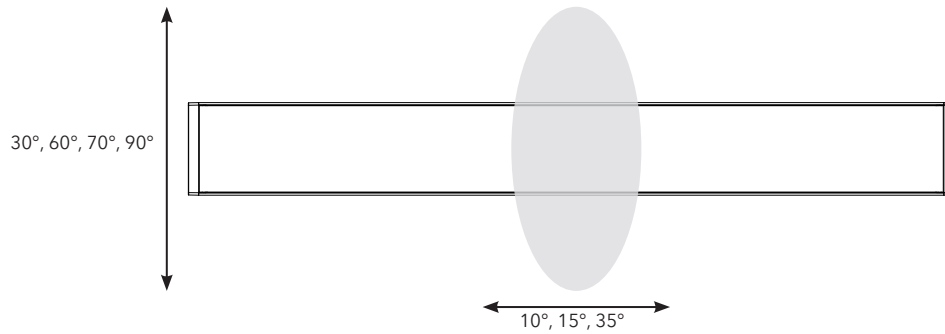

PHOTOMETRIC OVERVIEW

Based on RGBW version, all leds @ full

Lumen Output (lm)

	EMINERE SIDE 1	EMINERE SIDE 2	EMINERE SIDE 3	EMINERE SIDE 4
9°	1 147	2 294	3 441	4 588
15°	978	1 956	2 910	3 912
30°	1 046	2 092	3 138	4 184
50°	1 039	2 078	3 117	4 156
65°	1 040	2 080	3 120	4 160
100°	996	1 992	2 988	3 984
10° x 30°	1 032	2 064	3 096	4 128
10° x 60°	1 051	1 874	2 811	3 748
15° x 90°	970	1 940	2 934	3 880
35° x 70°	1 040	2 080	3 120	4 160
WallWasher	952	1 904	2 856	3 806
Wide WallWasher	854	1 708	2 562	3 416

COLOUR MIXING PRINTS

STAND ALONE

Specially designed glass printing to achieve optimal colour mixing and intensity distribution.

HEAD2HEAD

Fixtures without special end glass print installed right next to each other create absolutely perfect colour and intensity overlap.

Note:
Applies for RGBW, RGBA versions.
Pure white and Tunable white versions are always without the end print (no matter on their position to other fixture).

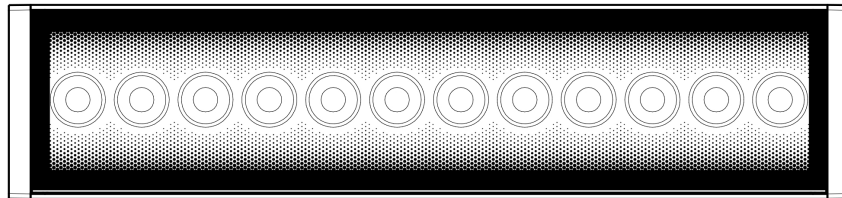

HEAD2HEAD

SYMMETRICAL

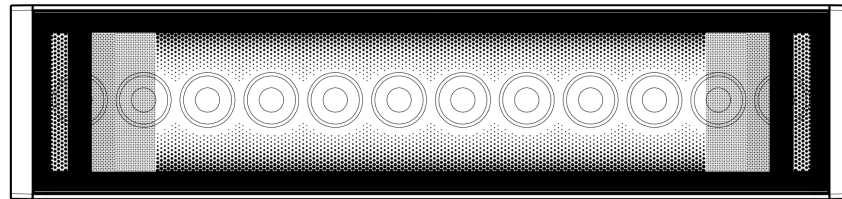

STAND ALONE

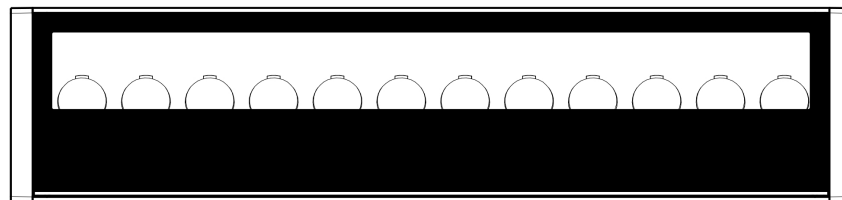

HEAD2HEAD

WALLWASHER

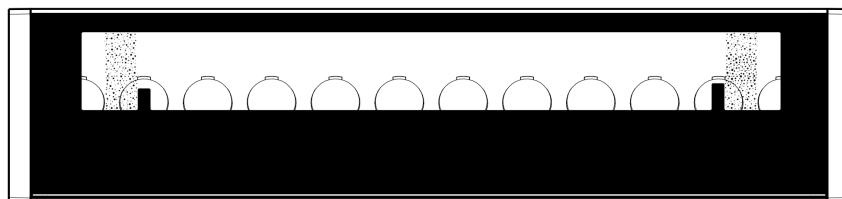

STAND ALONE

EMINERE SIDE INPUT OPTIONS

STANDARD

UPON REQUEST

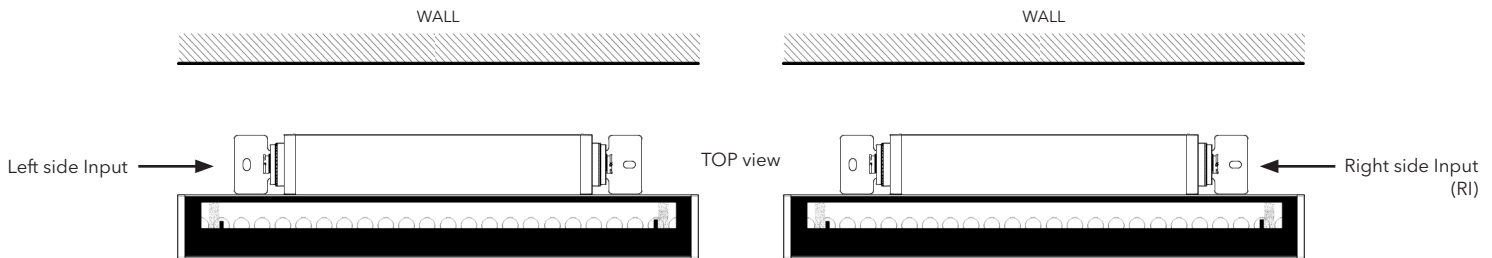

Note: Applies for all optic versions.

E-BOX SPECIFICATION

ELECTRICAL	Input Voltage	120 - 277 V AC 50/60 Hz		
	Wireless DMX (Option)	Lumen Radio CRMX Technology		
CONTROL	Interface Protocol	E-box Lite: USITT DMX512, RDM		
		E-box Daisy / Star: USITT DMX512, RDM, ArtNet, MA Net, MA Net2, sACN, Kling-Net		
	Operating Modes	E-box Lite / Daisy: Fixture Mode, Pixel Mode, Output Mode		
		E-Box Star: Total Mode, Fixture Mode, Pixel Mode, Output Mode		
	Display	Via Two Row LCD Display with Control Buttons or RDM communicator		
	Control System	E-box With Self Addressing Feature or Custom Setting Via LCD Display/RDM		
	Power Supply	Integrated		
CONNECTIVITY	E-box Lite	144 of Eminere Side 1 (@ 230 V and 40m cable) via 1 Output		
	E-box Daisy	144 of Eminere Side 1 (@ 230 V and 40m cable) via 1 Output		
	E-box Star	144 of Eminere Side 1 (@ 230 V and 40m cable) via 6 Outputs		
PHYSICAL	Length x Width x Height	E-box Lite	220 x 120 x 81 mm (8.66 x 4.72 x 3.18 in.)	
		E-box Daisy	260 x 160 x 91 mm (10.24 x 6.30 x 3.58 in.)	
		E-box Star	280 x 230 x 111 mm (11.02 x 9.06 x 4.37 in.)	
	Weight	1.67 kg 3.85 lbs	2.78 kg 6.13 lbs	4.4 kg 9.7 lbs
	Housing	Die-Cast Aluminium Case		
	Finish Options	Standard Colour - Graphite Black (RAL 9011) Silver (RAL 9006)		
		Cost Option - Custom RAL Harsh Environment (RAL 9016, RAL 9011)		
	Cables / Connections	Cable Grommet (stainless steel)		
	Mounting Method	Surface Mount , 4 Mounting Holes		
	Protection Factor	IP67 / Suitable For Wet Locations		
	IK Rating	IK10		
Cooling System	Convection			
Operating Ambient Temperature	-20 °C / +40 °C (-4 °F / +104 °F)			
CERTIFICATION	Listings	ETL / cETL, CE, RoHS		

COMPARISON

	E-BOX LITE	E-BOX DAISY	E-BOX STAR
Power input	1	1	1
Fixture Output	1	1	6
Total load (current)	16A	16A	16A
DMX control	YES	YES	YES
RDM	YES	YES	YES
Art-Net	NO	YES	YES
Ethernet switch	NO	YES	YES
Kling-Net	NO	YES	YES
sACN	NO	YES	YES
MA Net, MA Net2	NO	YES	YES

E-BOX LITE

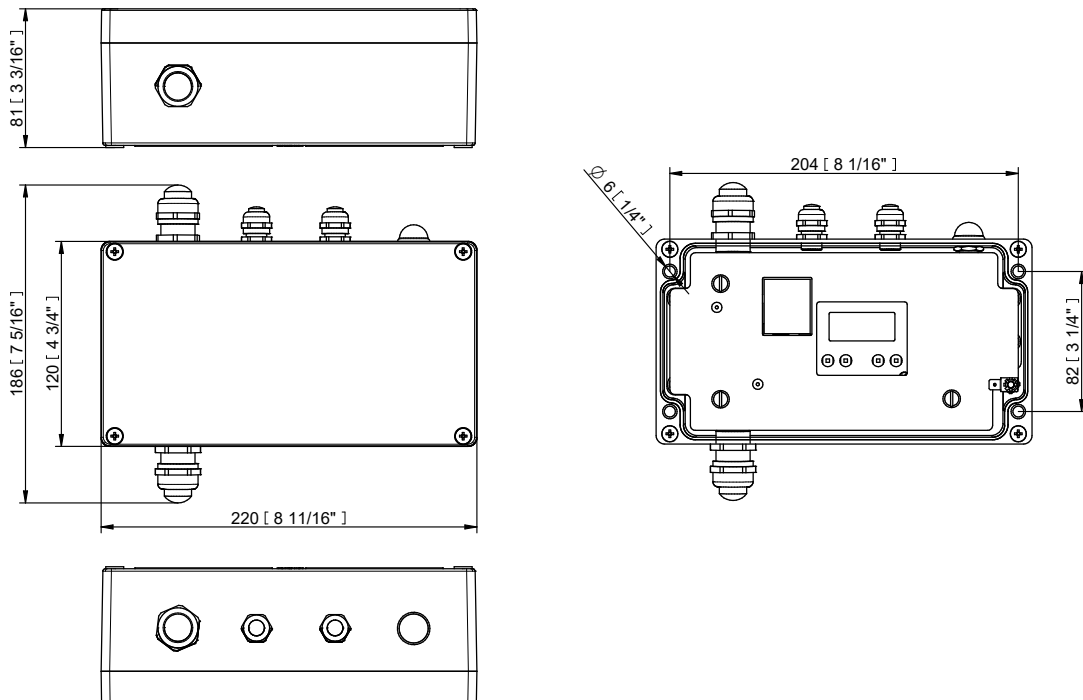

E-BOX DAISY

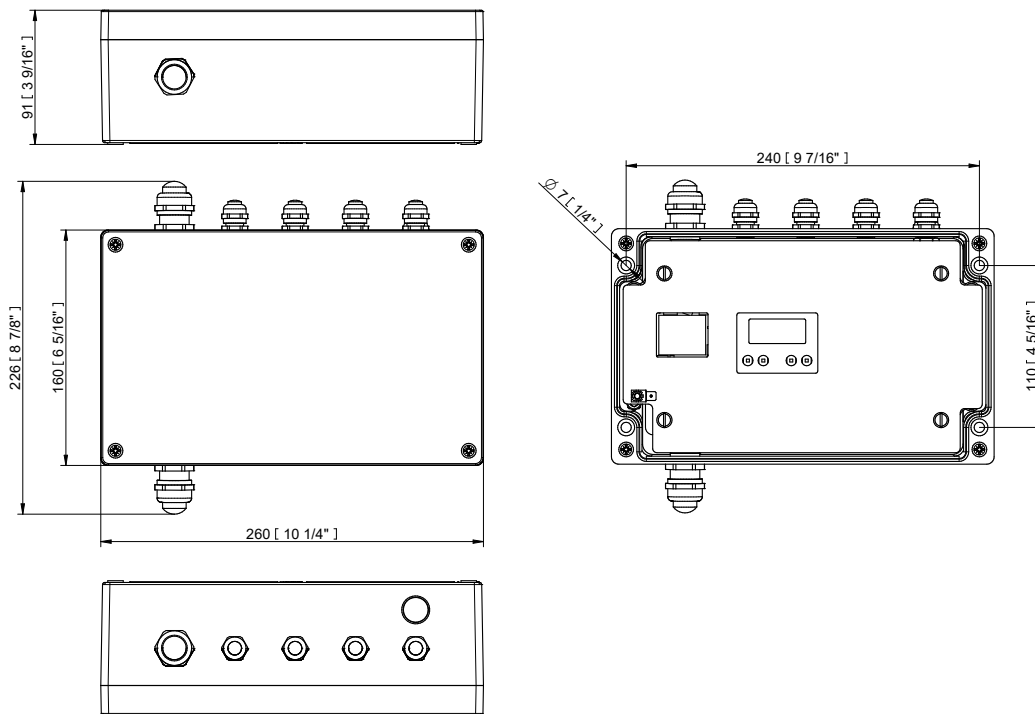

E-BOX STAR

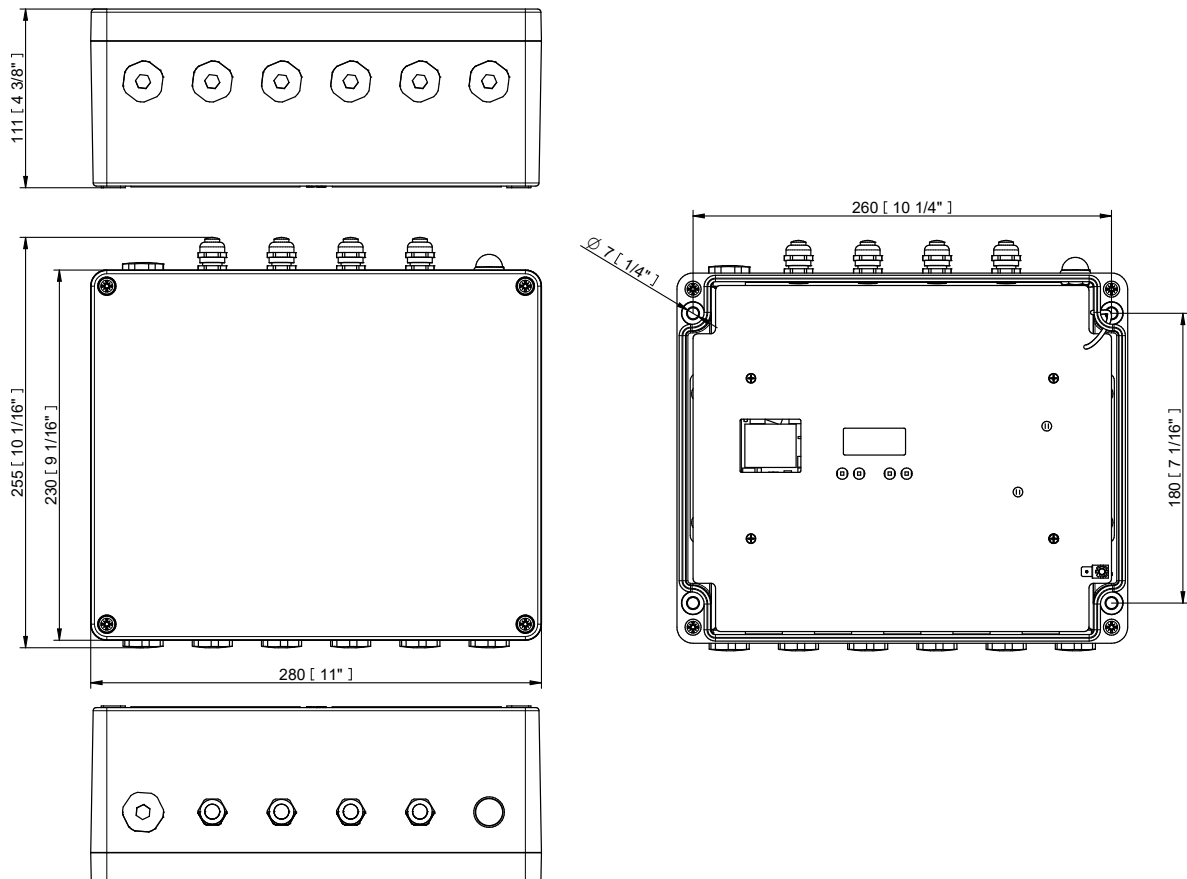

CONNECTION

E-BOX LITE / DAISY

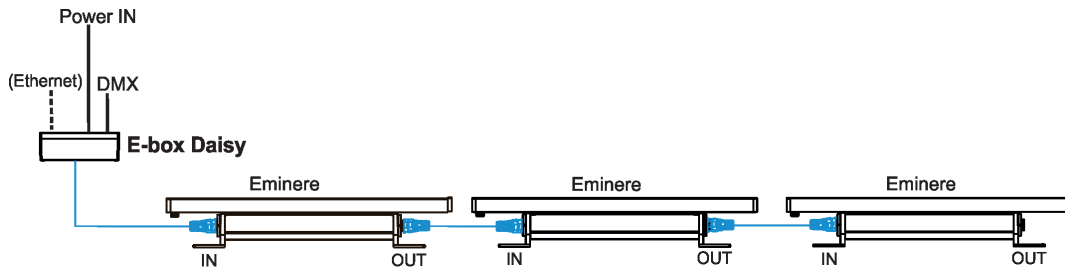

E-BOX STAR

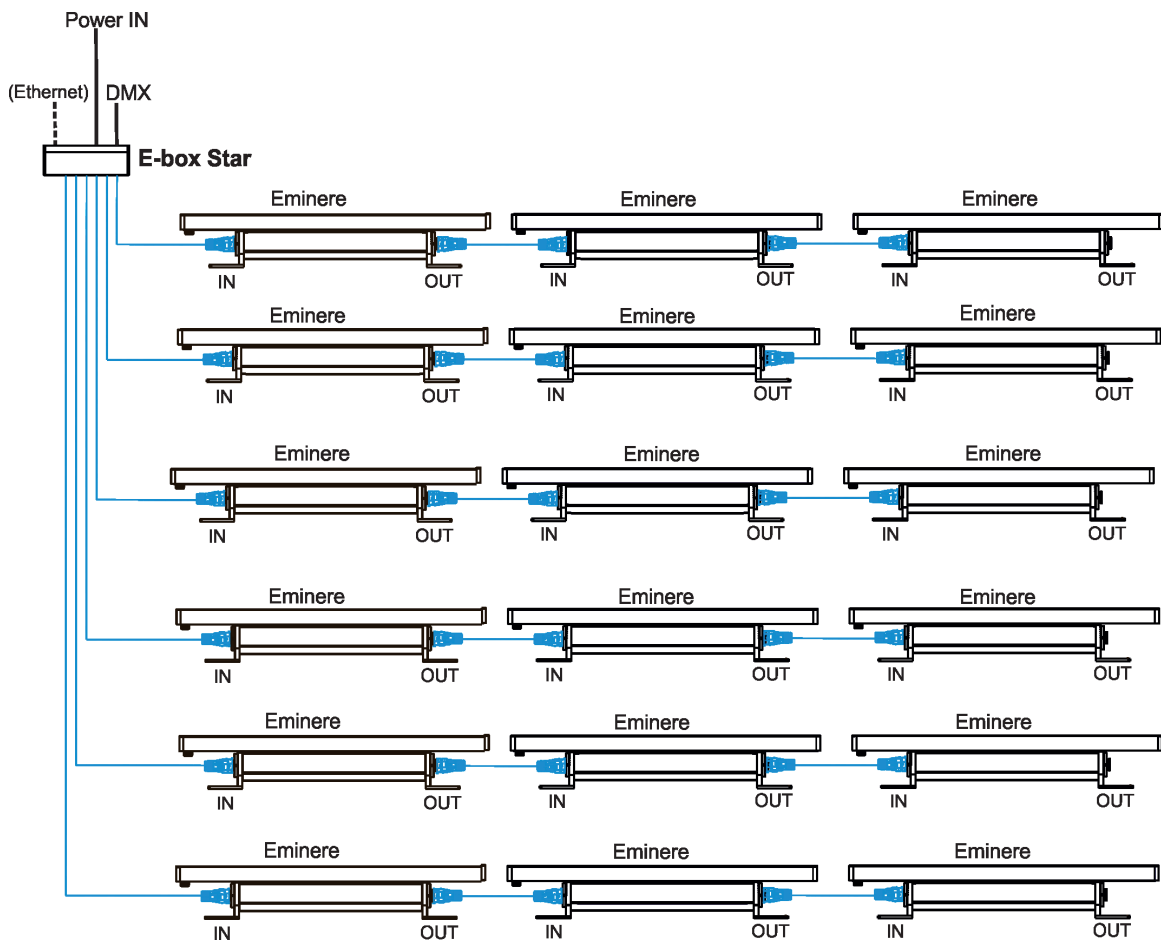

CONNECTION - WIRELESS VERSION

Connection setup, where every Eminere is independently accepting data from WIFI.



CONNECTIVITY

Following table shows maximum connected Emineres on each output of E-Box with respect of cable length.

	Cable length (m)	Voltage (V)				
		100	120	190	230	277
EMINERE SIDE 1	10	69	83	131	159	191
	20	61	83	131	159	191
	30	40	58	131	159	191
	50	24	35	88	128	186
	70	17	25	63	92	133
	100	12	17	44	64	93
	200	6	9	22	32	47
EMINERE SIDE 2	10	34	41	64	78	94
	20	30	41	64	78	94
	30	20	28	64	78	94
	50	12	17	43	63	91
	70	8	12	31	45	65
	100	6	9	21	31	46
	200	3	4	11	16	23

	Cable length (m)	Voltage (V)				
		100	120	190	230	277
EMINERE SIDE 3	10	23	28	44	53	64
	20	20	28	44	53	64
	30	13	19	44	53	64
	50	8	12	29	43	62
	70	6	8	21	31	44
	100	4	6	15	21	31
	200	2	3	7	11	16
EMINERE SIDE 4	10	17	21	33	40	48
	20	15	21	33	40	48
	30	10	15	33	40	48
	50	6	9	22	32	47
	70	4	6	16	23	38
	100	3	4	11	16	23
	200	2	2	5	8	12

* Cable length is a total cable length between E-box and last connected Eminere. Example: Total cable length=L1+L2+L3

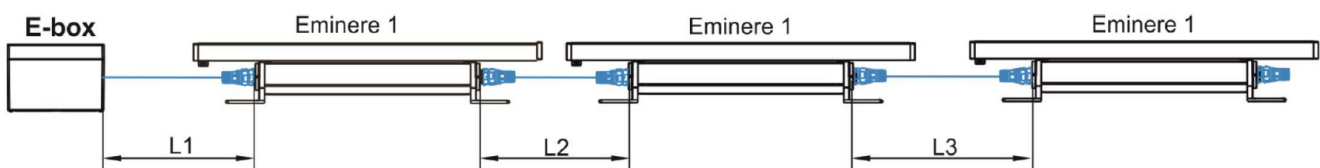

THE BOOSTER BOX

To compensate a voltage drop in a large installation, the Booster boxes have to be connected in the chain of Eminere modules.

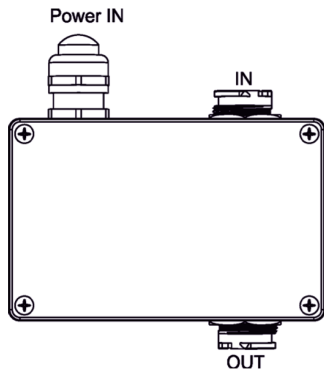

Example: E-box Daisy, Power supply= 230V, Cable length=70m, fixture=Eminere 2.
The Booster box has to be connected after every 45th Eminere 2 (fixture 45 and fixture 90) from 94 fixtures.

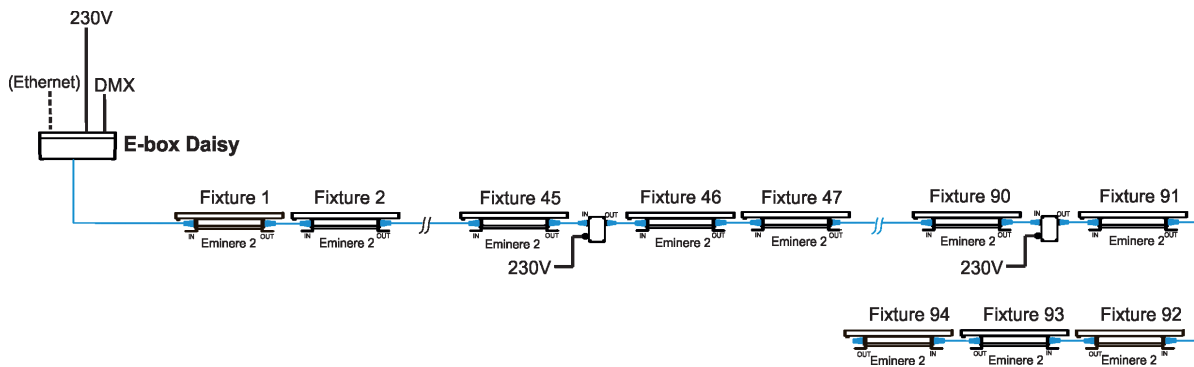

BOOSTER BOX POSITIONS

Cable length (m)	Max. number of Emineres Side 1 = 191 (in Standard mode)			
	120 V	190 V	230 V	277 V
10 m	83,166	131	159	-
20 m	83,166	131	159	-
30 m	58,116,174	131	159	-
50 m	35,70,105,140,175	88,176	128	186
70 m	25,50,75,100,125,150,175	63,126,189	92,184	133
100 m	17,34,51,68,85,102,119,136,153,170,187	44,88,132,176	64,128	93,186
200 m	9,18,27,36,45,54,60,72,81,90,99,108,117,126,135,144, 153,162,171,180,189,	22,44,66,88,110,132,154,176	32,64,96,128,	47,94,141,188

NOTE: For more detail see the User manual.

DIMENSIONS

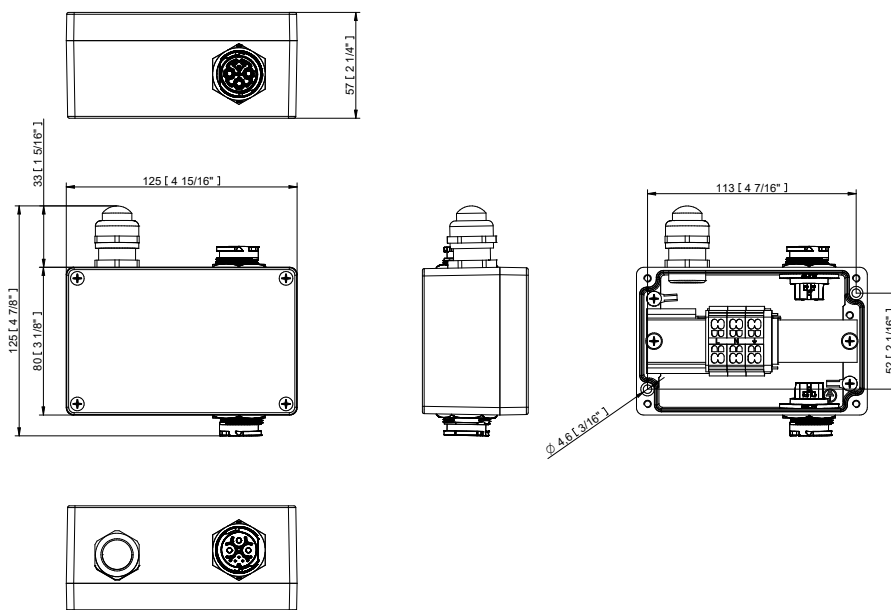

ACCESSORIES

Shield for Eminere Side

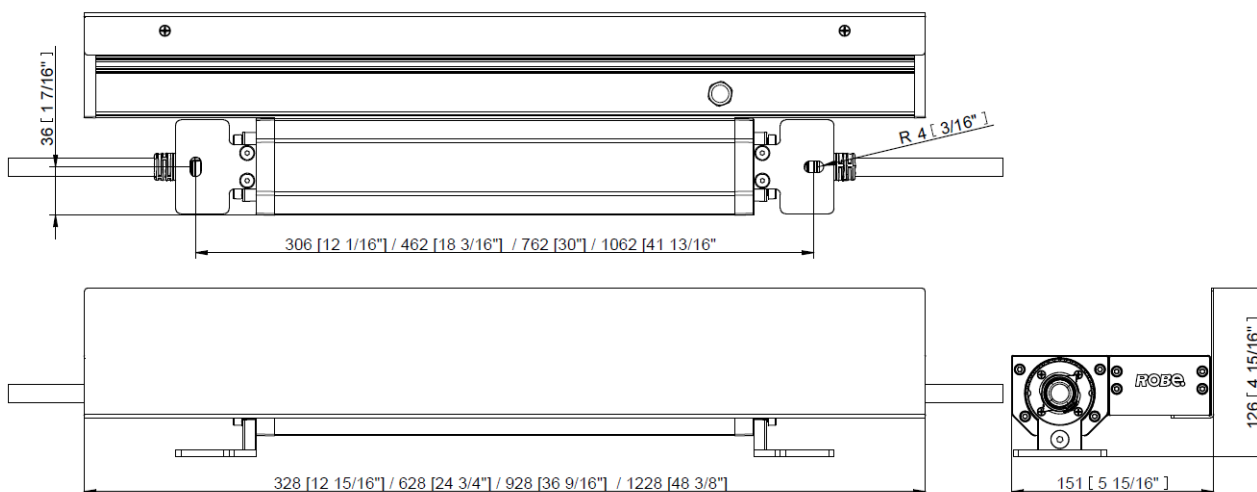

Mounting

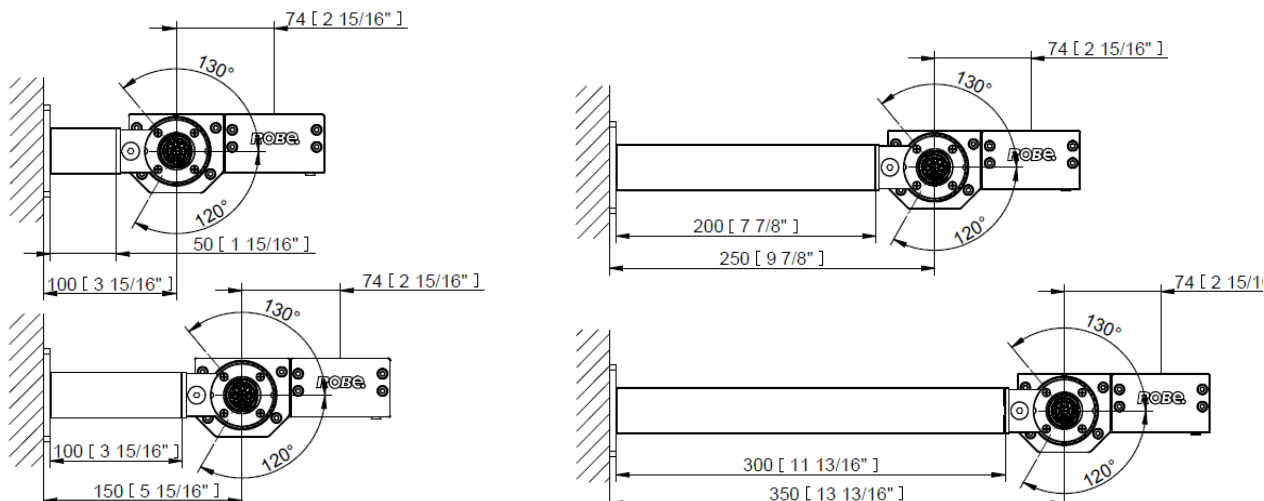

CABLES

Leader Cable - for connecting E-Box with first Eminere. Comes with Waterproof End Cap which has to be installed to the last Eminere's output connector.

Female connector
Female pins

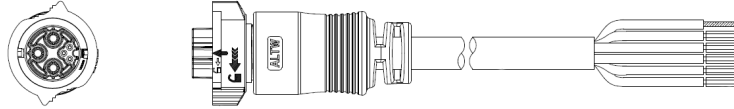

Jumper Cable - for connection between two Emineres.

Female connector
Female pins

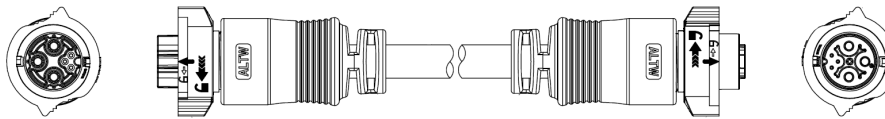

Female connector
Male pins

Field installable connector

- for special cases, where Jumper Cable can't be used. Then use Leader Cable with Field installable connector to make a connection between Emineres.

Female connector
Female pins

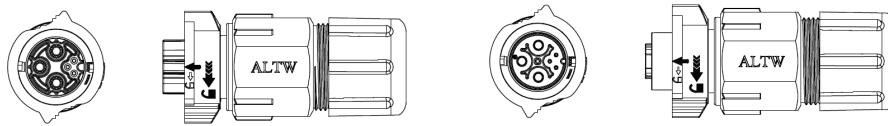

Female connector
Male pins

Output - panel connector
(front view)



Input - panel connector
(front view)

Waterproof End Cap - Install at the end of line to the last Emineres output connector.

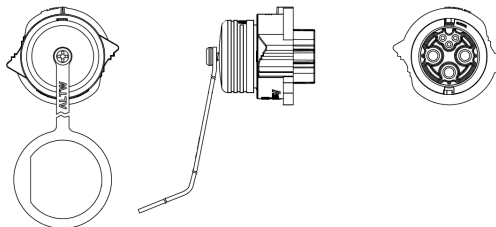

Cable lengths available

IN METRES	LEADER CABLE	JUMPER CABLE
0,25	-	YES
0,5	-	YES
1	-	YES
2	YES	YES
3	-	YES

IN METRES	LEADER CABLE	JUMPER CABLE
5	YES	YES
10	YES	YES
25	YES	-
50	YES	-

PHOTOMETRIC DATA

Eminere Side 4 RGBCW 9dg

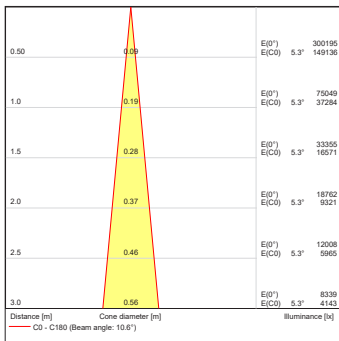
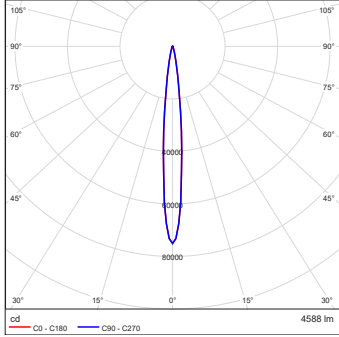

Eminere Side 4 RGBCW 15dg

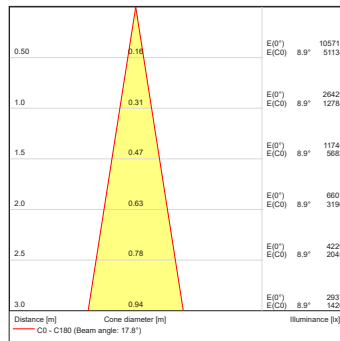
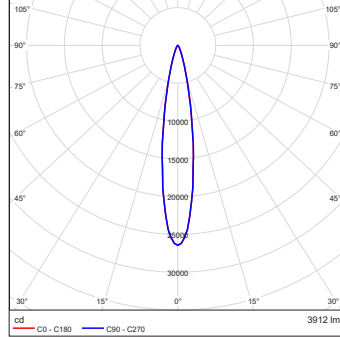

Eminere Side 4 RGBCW 30dg

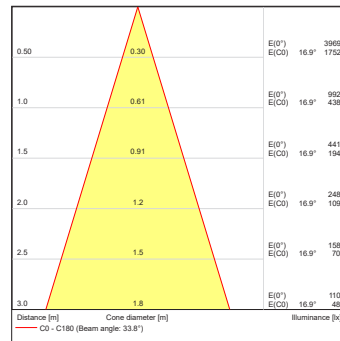
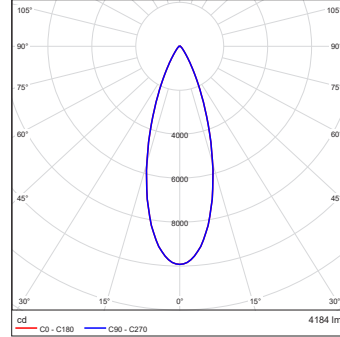

Eminere Side 4 RGBCW 50dg

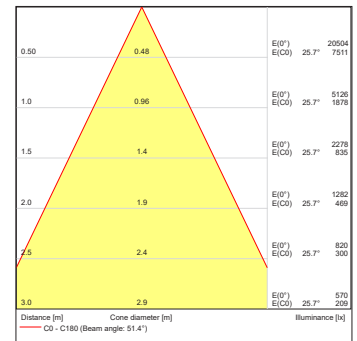
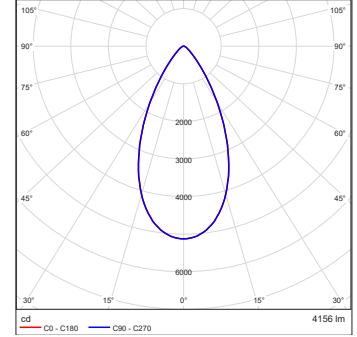

Eminere Side 4 RGBCW 65dg

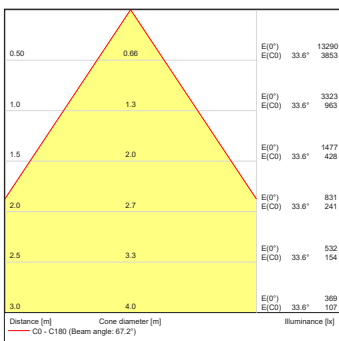
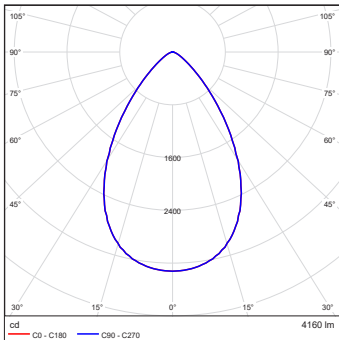

Eminere Side 4 RGBCW 100dg

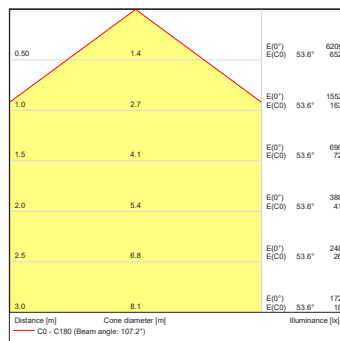
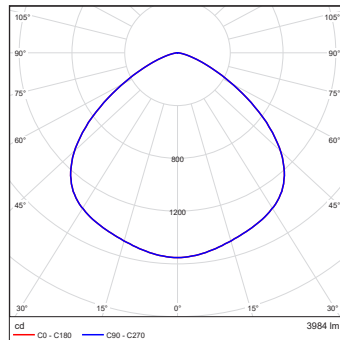

PHOTOMETRIC DATA

Eminere Side 4 RGBCW 10dg x 30dg

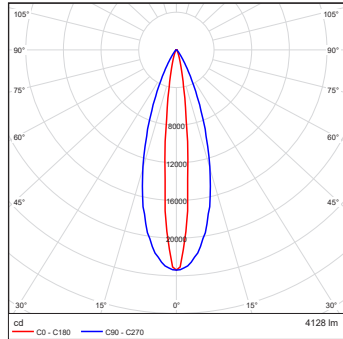

Eminere Side 4 RGBCW 10dg x 60 dg

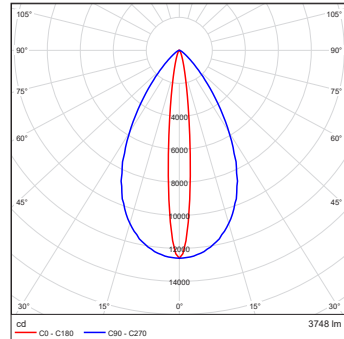

Eminere Side 4 RGBCW 35dg x 70dg

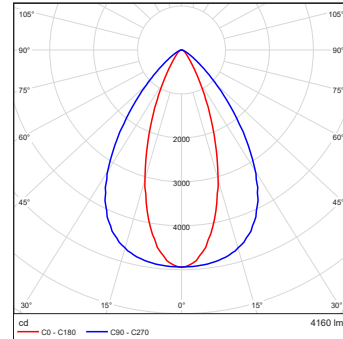

Eminere Side 4 RGBCW 15dg x 90dg

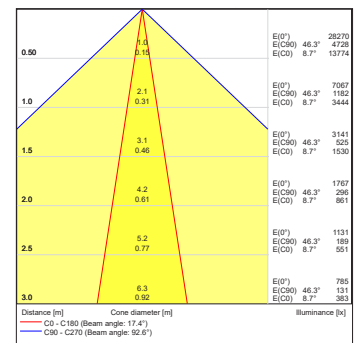
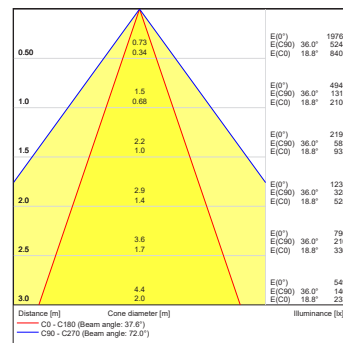
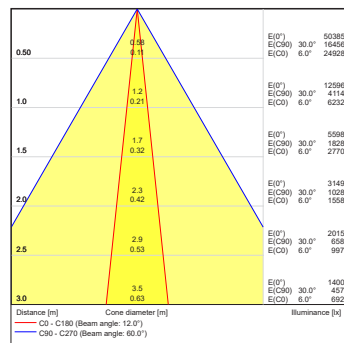
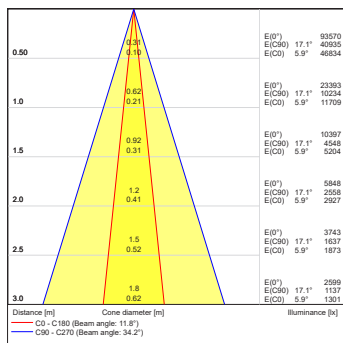
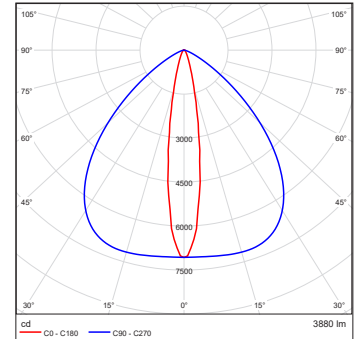

Eminere Side 4 RGBCW WallWasher

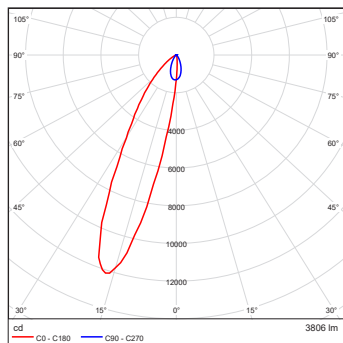

Eminere Side 4 RGBCW Wide Wall-Washer

