

# ARCDOT™

Excellent for large scale matrix applications due to its advanced pixel mapping capabilities, the ArcDot™ uses a Cree MC-E RGBW MultiChip with high light output that features a built-in intelligent electronic control system. This guarantees flicker free operation and overheating protection whilst remote addressing, calibration and status messaging is also included. Built to an IP67 rating ensures the unit is capable of withstanding tough weather conditions but is also perfect for a wide variety of interior installations.



## KEY FEATURES

Flicker free operation with advanced pixel mapping, remote addressing and status messaging with colour, lash and colour temperature options available.

### Lumen Output & Light Source

Lumen output of 139 lm is provided by high-power multichip LED.

### Power Consumption

5.5W energy consumption provides excellent efficiency with low operating costs.

### Physical

The durable cast aluminum body with opaque polycarbonate dome provides a compact, stylish and easy-to-mount solution. The fixtures physical dimensions are 77 x 71 mm (3.03 x 2.80 in) and it weighs 0.2 kg (0.44 lbs).

## CONTROL & PROTOCOLS



## STANDARD & SPECIFICATION



5 Year  
Warranty  
(Registered)

## FINISH OPTION



Graphite  
Black



Silver



Custom  
Paint Colour

## COLOURS



RGBW



RGBA



Pure  
White

## COLOUR TEMPERATURES

\* UPON REQUEST



3.000 K



6.500 K\*

## OPTIC OPTIONS



No Optic  
No Optics

**ARCDOT SPECIFICATION**

<b>ELECTRICAL</b>	Input Voltage	48 V
	Typical Power Consumption	5.5 W / 48 V
<b>OPTICAL</b>	Light Source	1 x 15 W Multichip LEDs
	Colour Variants	RGBW (W - 6500 K)   RGBA   PW (W - 3000 K)
	Beam Angle	non-optic
	Lumen Output Delivered	139 lm (RGBW 7° W - 6500 K, all LEDs on full, 700 mA)
	Projected Lumen Maintenance	50.000 hrs (L70 @ 25 °C / 77 °F)
<b>CONTROL</b>	Control System	ArcPixel Power, ArcPower Unit Pixel
	Power Supply	ArcPixel Power, ArcPower Unit Pixel
<b>PHYSICAL</b>	Width x Height	Ø 77 x 71 mm   Ø 3.03 x 2.80 in.
	Weight	0.2 kg   0.44 lbs
	Finish Options	Standard Colour - Graphite Black (RAL 9011)   Silver (RAL 9006)
		Cost Option - Custom RAL
	Housing	Cast Aluminium
		Polycarbonate Dome
	Cables / Connections	Li9Y11Y, 2 x AWG16 + 1 x AWG20, Chogori IP67 connector
	Mounting Method	Mounting Back Plate
	Protection Factor	IP67 / Suitable For Wet Locations
	IK Rating	IK10
	Cooling System	Convection
Operating Ambient Temperature	-20 °C / +50 °C (-4 °F / +122 °F)	
Operating Temperature	+35 °C @ Ambient +25 °C (+95 °F @ Ambient +77 °F)	
<b>CERTIFICATION</b>	Listings	ETL / cETL, CE, RoHS , UKCA
<b>ACCESSORIES</b>		Cable Connection ArcDot 1   5   10m
		Connector T- CGRBA (3-pin)
		Connector CGRBB-03BMMA-SL8001 (Male)
		Connector CGRBB-03BFFA-SL8001 (Female)
		Terminator Active for Arc Dot / ArcSource Outdoor 4MC Pixel
		Terminator Passive for Arc Dot / ArcSource Outdoor 4MC Pixel
		Cable, w/out connectors (1m)
		Ferrite GTFC 16-8-16

**PHOTOMETRIC OVERVIEW**

Lumen Output (lm) - Clear Glass

	RGBCW (6500 K)	RGBA	PW (3000 K)
<b>Flat Clear Glass</b>	172	152	141
<b>Frosted Dome</b>	207	183	169
<b>Opaque dome</b>	139	123	114

**DIMENSIONS**

ArcDot

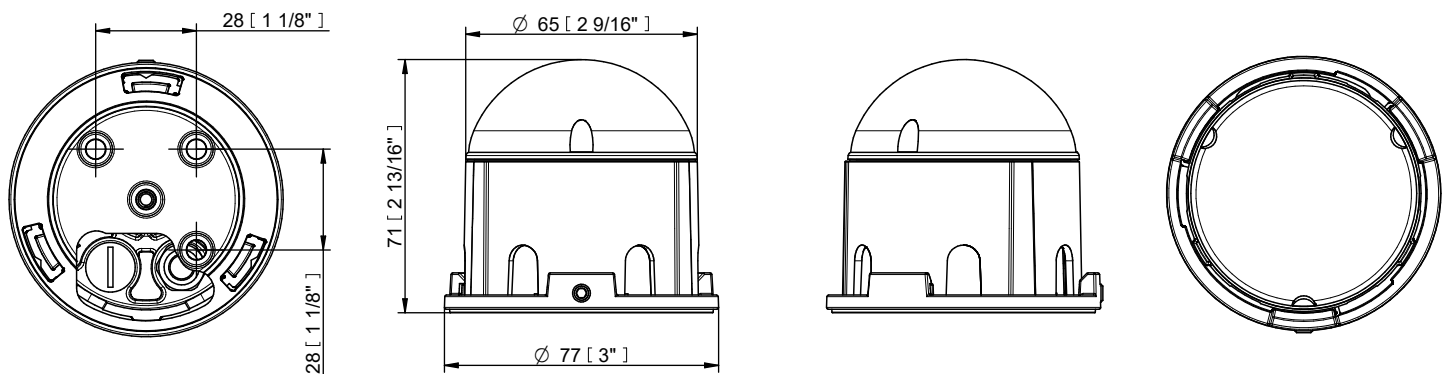

**ACCESSORIES**

Cable Connection ArcDot 1 / 5 / 10 m



Connector T- CGRBA (3-pin)



Connector CGRBB-03BMMA-SL8001 (Male)



Connector CGRBB-03BFFA-SL8001 (Female)



Terminator Active for Arc Dot



Terminator Passive for Arc Dot - terminal part of ArcDot connection.



**CONNECTION**

ArcDots can be connected one by one with using connectors CGRBB-03BMMA-SL8001 and CGRBB-03BFFASL8001. T-connectors can be used in case if we need connect ArcDot indirectly one after another.

Example of connection

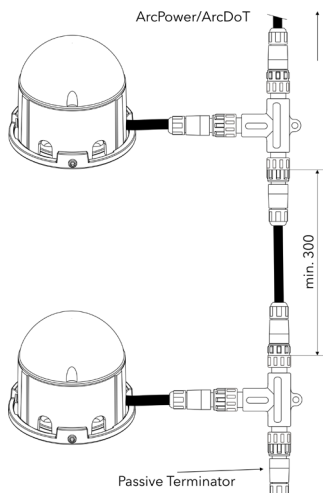
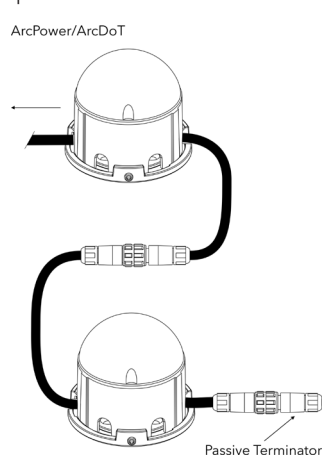

The minimum cable length of 0.3m between two T-connectors has to be kept in case that the pixel sorting is executed manually from the ArcPix Power menu.

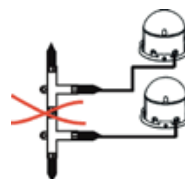

Every ArcDot line has to be terminated with the passive terminator!

ArcPixel Power / ArcPower Unit Pixel

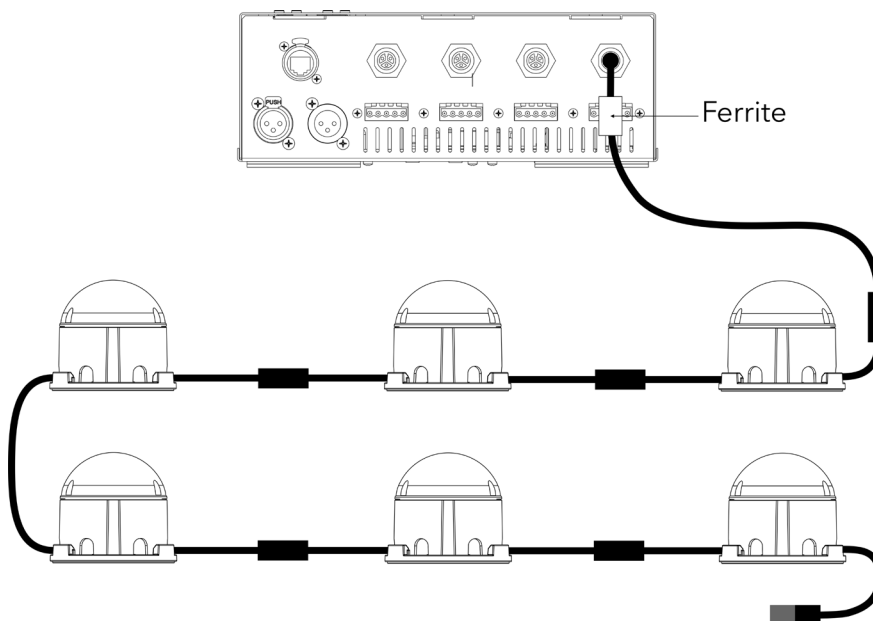

**PROJECTED AREA**

	m <sup>2</sup>	ft <sup>2</sup>
<b>Front (rear)</b>	0,004	0,046
<b>Side</b>	0,04	0,046
<b>Top</b>	0,005	0,05

**PHOTOMETRIC DATA**

ArcDot RGBCW Flat-Clear Glass

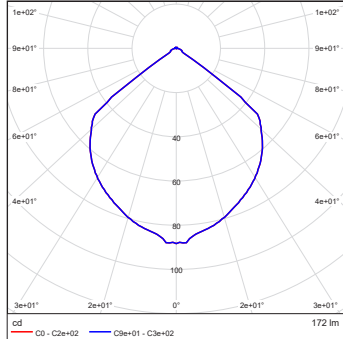

ArcDot RGBCW Frosted dome

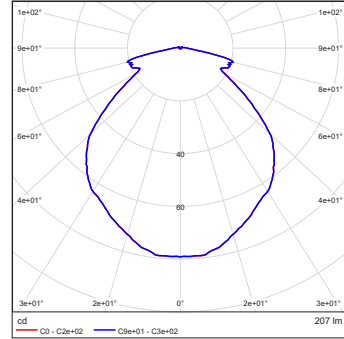

ArcDot RGBCW Opaque dome

