

DIVINE™ 60UV

Excellent for theme parks, attractions, leisure facilities and entertainment venues that require a true UV “black light” effect, both indoors and outdoors, this 180 Watt full LED luminaire produces high UV output levels at a 365 nm wavelength. Built-in DMX and RDM control enables precise lighting levels and the wireless control option allows retrofitting into existing installations without additional infrastructure. All the components are rated UV-stable and housed inside an IP67 rated casing, tough enough for the most challenging applications.



KEY FEATURES

Almost undetectable luminescence at normal lighting frequencies. Powerful output for indoor & outdoor effects.

Light Source

Light output is provided by 60 UV LEDs with 16,000 hrs (L70@25 °C / 77 °F) projected lumen maintenance.

Power Consumption

Typical power consumption of the luminaire is 180 W ±10 %

Physical

Divine 60UV fulfills an IP67 rating and is suitable for wet locations.

Control

Any third-party DMX controller can be used to control Divine 60UV.

COLOURS



UV

CONTROL & PROTOCOLS



OPTIONAL



OPTIC OPTIONS



38°

STANDARD & SPECIFICATION



Warranty

FINISH OPTIONS



Graphite Black



Silver



RAL

Custom Paint Colour

DIMENSIONS

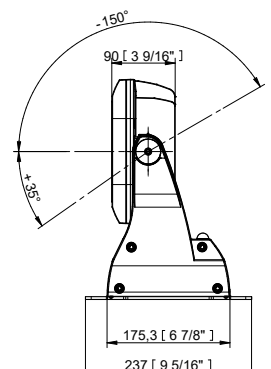
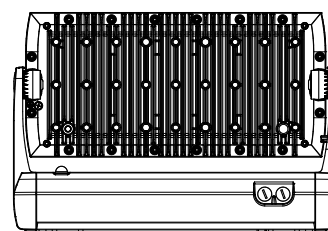
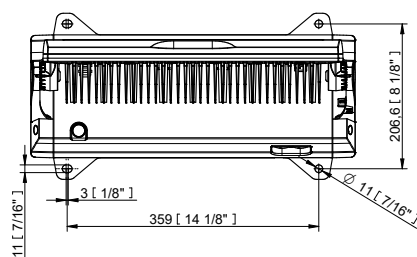
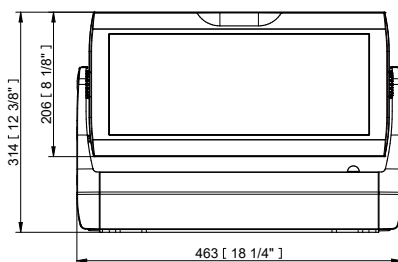

DIVINE 60 UV SPECIFICATION

ELECTRICAL	Input Voltage	100 - 277 V AC 50/60 Hz		
	Typical Power Consumption	180 W +/- 10 %		
	Inrush Current	30 A @ 230 V, 20 A @ 115V		
OPTICAL	Light Source	60 x UV LEDs		
	Wave Length	365 nm (peak)		
	Beam Angle	38°		
	Projected Lumen Maintenance	16.000 hrs (L70 @ 77 °F / 25 °C)		
CONTROL	Display	LED Display (Inside Integrated Junction Box)	Chassis Mounted LED Display (Optional)	
	Wireless DMX (Option)	Lumen Radio CRMX Technology		
	Interface Protocol	USITT DMX512, RDM, 0-10 V		
	Control System	Third Party DMX Controllers		
	Operating Modes	DMX, Stand-alone		
	DMX Modes Channels	3 2, 3, 9		
	Programs / Functions / Features	Editable Program: 1 (up to 40 steps)		
	Settings / Addressing	Via LED Display with Control Buttons or RDM		
	Power Supply	Integrated		
	PHYSICAL	Width x Height x Depth Weight	463 x 314 x 175 / 237 mm (18.2 x 12.4 x 6.9 / 9.3 in.) 14.5 kg / 32 lbs	
Housing		High Pressure Die-Cast Aluminium Body	Tempered Glass	
Finish Options		Standard Colour - Graphite Black (RAL 9011), Silver (RAL 9006)	Cost Option - Custom RAL	
Cables / Connections		Integrated Junction Box With Terminal Block	Recommended: Li9Y11Y 3 x AWG16 + 1(2xAWG24)	
Mounting Method		Surface Mount, Flush (J-Box), C-Clamp (For Side Connection Only)		
Adjustability		+35° / -150°		
Protection Factor IK Rating		IP67 / Suitable For Wet Locations IK 10		
Cooling System		Convection		
Operating Ambient Temperature		-20 °C / +40 °C (-4 °F / +104 °F)		
Operating Temperature		+70°C @ Ambient + 40°C (+158°F @ Ambient + 104°F)		
Total Heat Dissipation		680 BTU/h (calculated)		
CERTIFICATION		Listings	ETL / cETL, CE, RoHS, UKCA	
ACCESSORIES			Surface Mount Adaptor (Included)	
		Top Hat Divine 60 UV		
		Half Top Hat Divine 60 UV		
		Wire Guard/Anti-Glare Divine 60 UV		
		Adaptor w/ Black Glass for Divine 60 UV		
		Set of Rubber Feet		
		C-Clamp Adaptor Divine (for side conn. only)		
	Single Top Loader Case Divine			

PROJECTED AREA

		m ²	ft ²
Divine 60 UV	Front (rear)	0,13	1,40
	Side	0,03	0,32
	Top	0,08	0,86
Divine 60 UV with Top Hat	Front (rear)	0,13	1,40
	Side	0,0457	0,491
	Top	0,1	1,11
Divine 60 UV with Half Top Hat	Front (rear)	0,13	1,40
	Side	0,0412	0,443
	Top	0,1	1,11

ACCESSORIES FOR DIVINE 60 UV

Half Top Hat Divine 60 UV

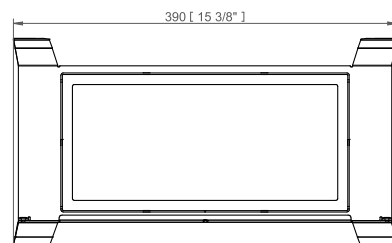
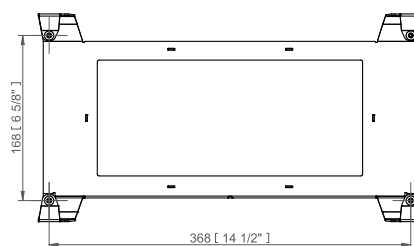
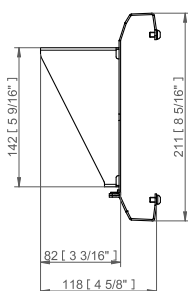

Wire Guard / Anti-Glare Divine 60 UV

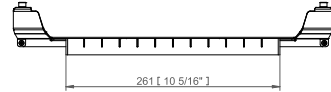
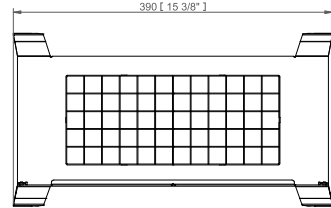
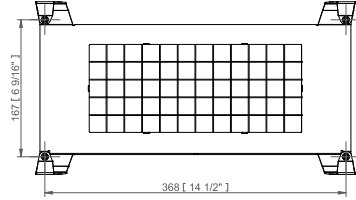
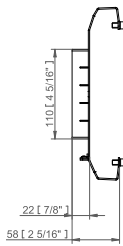

Adaptor w/ Black Glass for Divine 60UV

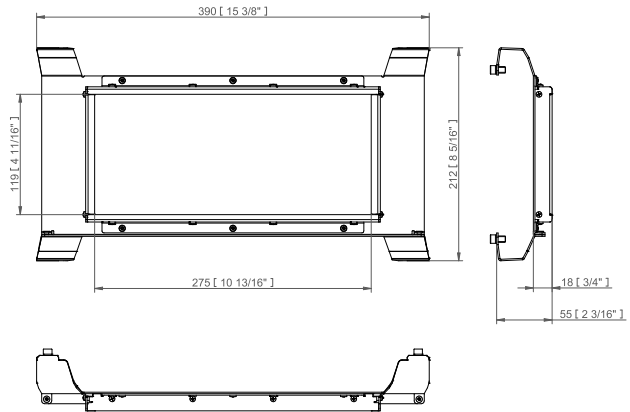

Set of Rubber Feet



Top Hat Divine 60 UV

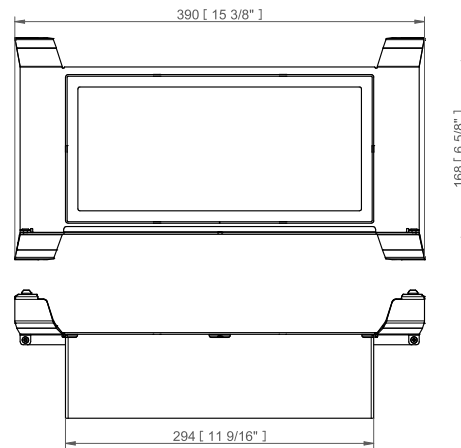
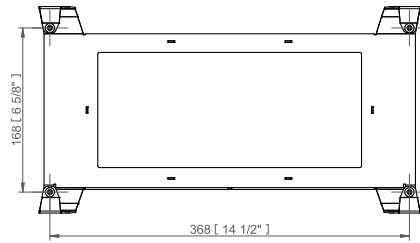
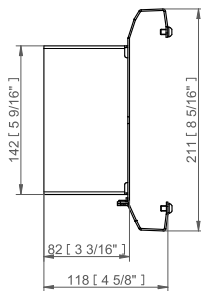

C-Clamp Adaptor Divine (for side conn. only)

