

Anolis designs and manufactures the highest quality LED architectural lighting. All products are designed in our state of the art R&D facility by industry experts with over 10 years experience in their field. Our fixtures are extensively tested to ensure they perform perfectly in the environment they were designed for. Utilisation of the latest LED technology ensures low power consumption and long lumen maintenance intervals.

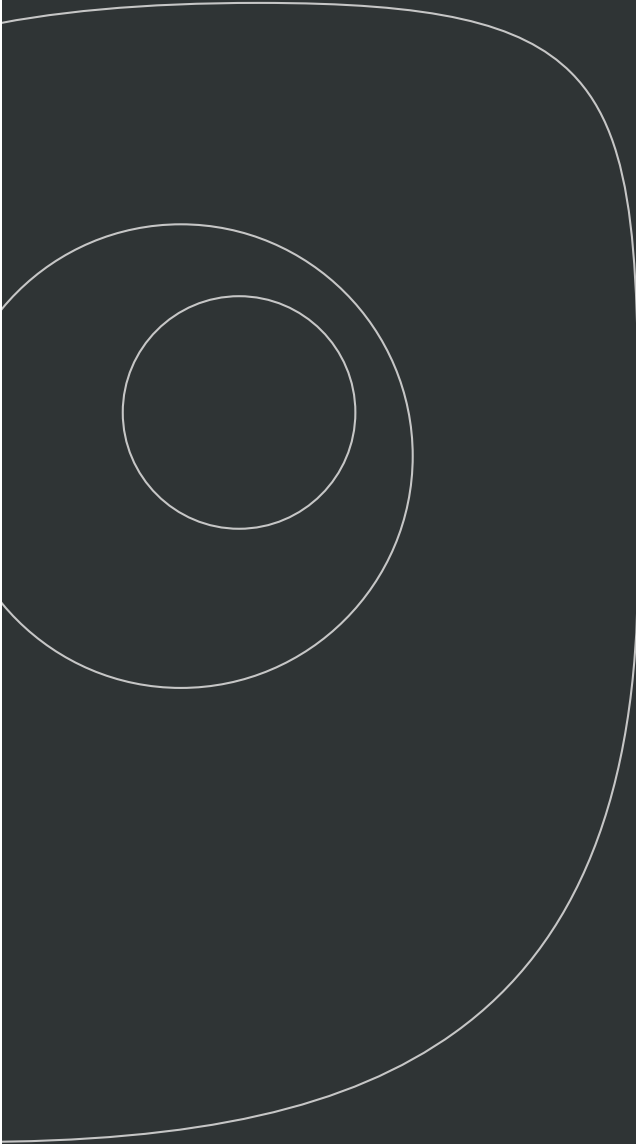

Eminere **8**

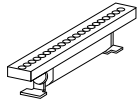

Eminere 1/2/3/4 **18**

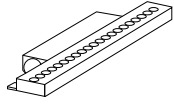

Eminere Side 1/2/3/4 **20**

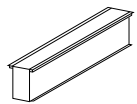

Eminere Inground 1/2/4 **22**

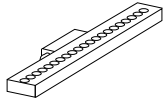

Eminere Remote 1/2/3/4 **24**

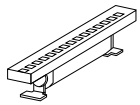

Eminere UV 2/4 **26**

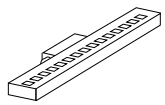

Eminere Remote UV 1/2/4 **28**

Calumma **30**



Calumma XS MC **40**

Calumma S MC **42**

Calumma M MC **44**

Calumma L MC **46**

Calumma XL MC **48**



Calumma S SC **50**

Calumma M SC **52**

Calumma L SC **54**

Calumma XL SC **56**

Divine **58**



Divine 160 **66**

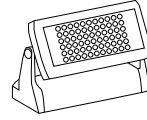

Divine 72 **68**

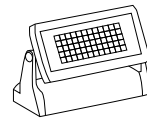

Divine 60 UV **70**

Content

Arc 72

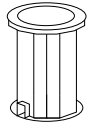

ArcSource Inground 24MC Integral 80



ArcSource Submersible II 82

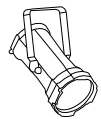

ArcPar 150 Outdoor 84



ArcDot 86

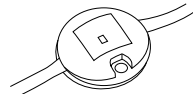

ArcPix II 88

ProMotion 114

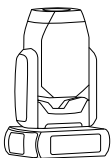

ProMotion 122

Ambiane 90



Ambiane XP56 Recessed 98

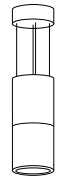

Ambiane XP56 Pendant 100

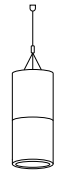

Ambiane XP56 Pendant Remote 102

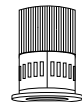

Ambiane HP111 Recessed 104



Ambiane HP111 Pendant Remote 106



Ambiane HP111 Surface Mount 108

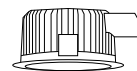

Ambiane AP 110

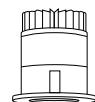

Ambiane SP16 112

Drivers 124

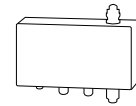

E-Box Lite 132

E-Box Daisy 134

E-Box Star 136

E-Box Remote 138

E-Box Remote Basic 140

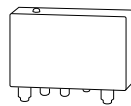

SubDrive 1 142

SubDrive 4 144

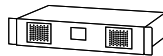

ArcPower Unit 146

ArcPower Unit Pixel 148

Ambiane Power Rack 150

ArcPixel Power 152

Control 154



ArcControl DU 162

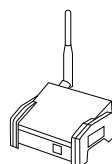

RUNIT WTX 164

The Architecture of Light

Leading global manufacturer of high end architectural LED lighting, Anolis boasts an extensive range of fixtures to provide solutions for almost any environment. Our fixtures are renowned for longevity, high efficiency and environmental friendliness.

European Manufacturing

We are proud to manufacture all fixtures at our global Headquarters and factory in the Czech Republic, where we have complete control over the production process. All fixtures are ETL/cETL, CE and RoHS certified so you can be sure they will comply with local compliance laws. Only the best components are used in the production of Anolis products, coupled with the latest manufacturing techniques and machines, to ensure optimum performance for many years to come – even in the toughest environmental conditions. All fixtures undergo intensive product testing to ensure perfect performance.

Trusted Supplier

At Anolis we develop excellent relationships with our customers and distributors and welcome feedback on our fixtures in order to ensure continuous improvement. Our projects include large citywide architectural ventures across the globe: spectacular installations from Marina Bay Sands in Singapore and Waddesdon Manor in the UK, to the Mall of Africa.

Advanced R&D

The attention to detail that underlies our products starts at the Anolis R&D centre where all fixtures are designed in-house. Research and development is a core feature of the business so we invest heavily to develop the innovative solutions to our customers' challenges. The highly trained research engineers are dedicated to designing the most efficient and durable fixtures possible to match a huge range of applications including architectural, retail, commercial, industrial, domestic and entertainment.

Global Distribution

With 9 offices, and through our worldwide distribution network, we serve customers across the globe. Anolis also continues to develop its support network, working with organisations worldwide to ensure excellent customer service.

Anolis Lighting
Outdoor

Introduction

La Porte de Bourgogne, France

Eminere™ 1

Eminere™ 4

ArcSource™ Outdoor 48MC



Eminere™ series



Precision in all its colours

The new Eminere range by Anolis builds on the success of the original ArcLine Outdoor Series with precision optics and is available in a variety of sizes. It's perfect for a wide range of exterior and interior applications such as Flood Lighting, Wall Grazing, Wall Washing and Accent Lighting. Built to exact standards, these linear fixtures are durable enough to withstand extreme environments whilst producing beautiful colours from the RGBW, RGBA or PureWhite LED chips.



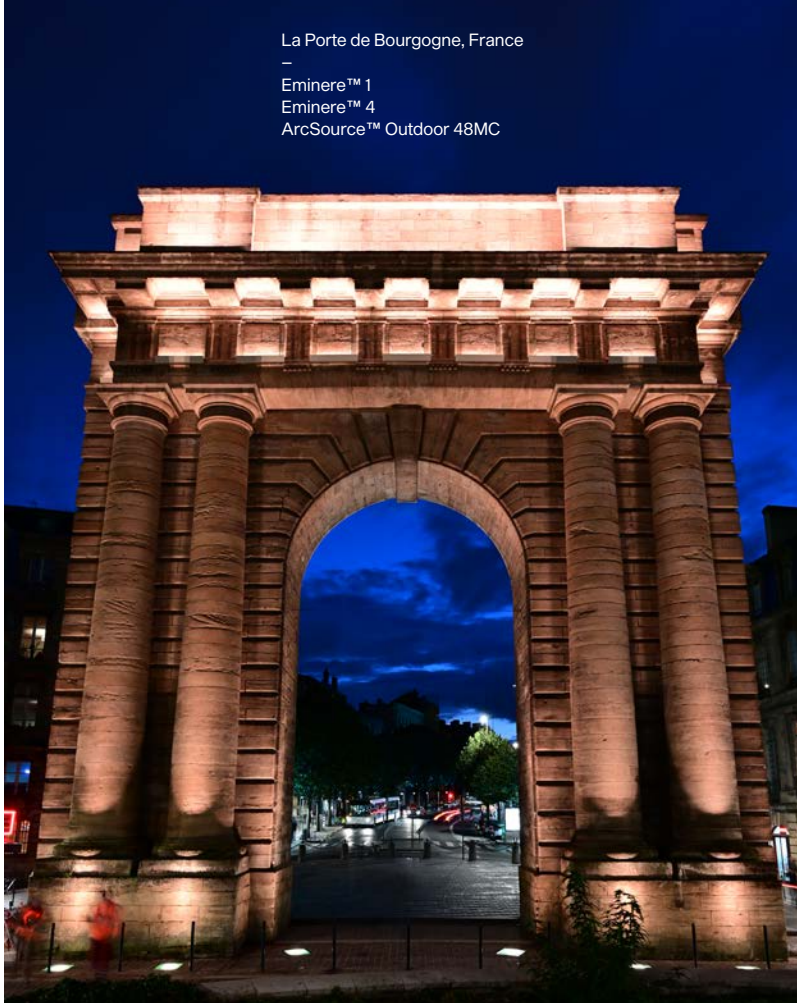

La Porte de Bourgogne, France
—
Eminere™ 1
Eminere™ 4
ArcSource™ Outdoor 48MC

Architectural lighting has never been easier with linear LED fixtures designed to be the new industry standard. Eminere's flexibility offers designers a powerful tool to meet the most demanding scenarios of placement, environment, and light distribution. The ability to select specific LED chips across a wide range of colour temperatures combined with high-quality holographic filters delivers precise colour mixing and exceptional beam definition.

Absolutely limitle∞

Waltham Forest Town Hall, UK

—

Eminere™ 1/2/3/4

Eminere™ 2 Inground

E-Box™



Waltham Forest Town Hall

A vibrant and elegant new Anolis Eminere LED lighting design by architectural lighting practice Pritchard Themis is gracing the front facades of Waltham Forest Town Hall in East London, UK. The impressive Grade II listed building is the HQ of Waltham Forest London Borough Council, and the exterior lighting scheme was part of a substantial two-year refurbishment and upgrade project involving the whole building and its immediate environs. Hawkins\Brown architects was appointed to transform the stripped classical style Town Hall opened in 1942 into an integrated modern workspace combined with a lively civic campus. As part of that masterplan, Hawkins\Brown tasked the Pritchard Themis team with crafting the exterior lighting. Using the quality output and superior colour mixing of Anolis, a stylish signature white illumination was created for the front of the building, complete with an array of dazzling colour changing special looks to celebrate 'flag days', national and ethnic festivals plus other cultural and social events.

Waltham Forest Town Hall, UK

Eminere™ 1/2/3/4
Eminere™ 2 Inground
E-Box™



Façade as you wish

Green

Yellow

Yellow

White

Orange

Lime

Cyan

Gold

Pink

Coral

Red

Teal

Purple

Navy

Beige

Warm

Indigo

Aqua

Khaki

Blue

Gray

Linen

Azure

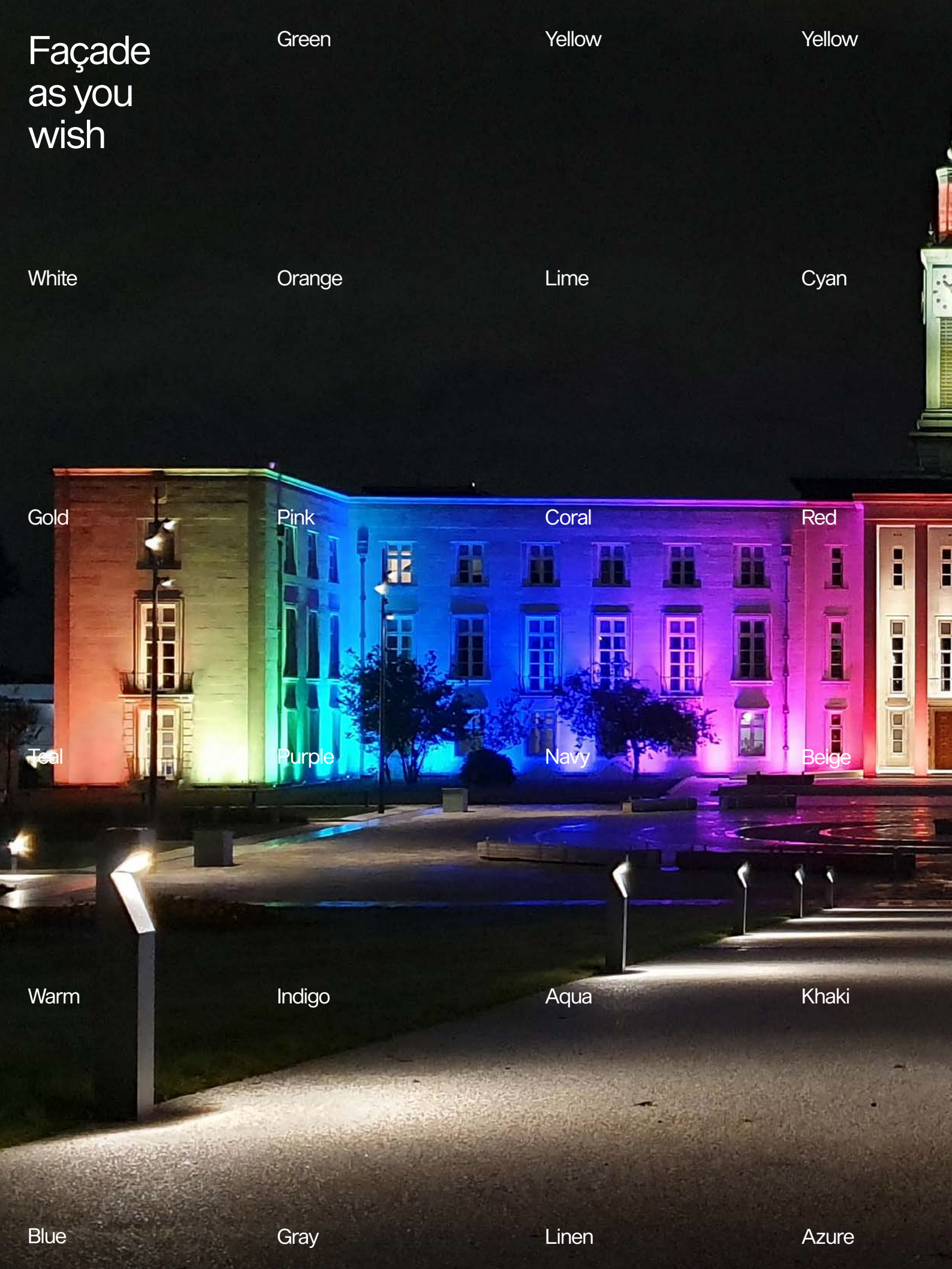

Blue

Green

Yellow

Azure

White

Orange

Lime

Cyan

Gold

Pink

Coral

Red

Teal

Purple

Navy

Beige

Teal

Indigo

Aqua

Khaki

Teal

Gray

Linen

with
Eminere™



Eminere™ series

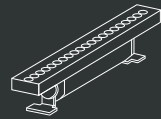

Product
Type

Eminere™

Product Overview
Page Number

18–19

Technical Specification
Page Number

172

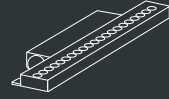

Eminere™ Side

20–21

174

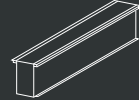

Eminere™ Inground

22–23

176

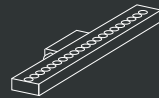

Eminere™ Remote

24–25

178

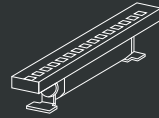

Eminere™ UV

26–27

180

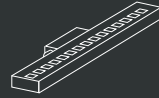

Eminere™ Remote UV

28–29

182

Eminere™

Eminere was designed by Anolis for a wide range of exterior and interior applications with a variety of lens options that can be used for flood lighting, wall grazing, wall washing and accent lighting. Equipped with Anolis' unique 18-bit colour mixing resolution ensures extra fine colour tuning as well as smooth dimming at low level of intensity. Designed in our state of the art R&D facility by industry experts with over 10 years experience in their field, Eminere is IP67 rated and can withstand extreme conditions. Eminere is available in 1, 2, 3, and 4 foot sizes (300/600/900/1200 mm) with RGBW, RGBA or PureWhite single chips as standard and is easy to control, 1 pixel per foot. Eminere fixtures can be used for both permanent and temporary installations, including various architectural and architainment applications.



- Quick and Easy Installation** Plug & Play system means easy installation, fast adjustment and intuitive programming with self-addressing.
- Durability** Eminere is rated IP67, suitable for wet locations and has a protection rating of IK06. Marine grade finish option also available for harsh environmental conditions.
- Application Flexibility** Eminere's optics can be used for various applications including wall grazing, flood lighting, wall washing, wide flood lighting, spot lighting and accent lighting.
- Naturally Looking Result** Full spectrum coverage by using RGBW colour mixing with precise wavelengths of each colour for modern architecture or specifically designed combination of RGBA to highlight every single detail of historical buildings or monuments. Output up to 1147 lm (RGBW) or 1652 lm (PW) per one foot of Eminere.

Scale

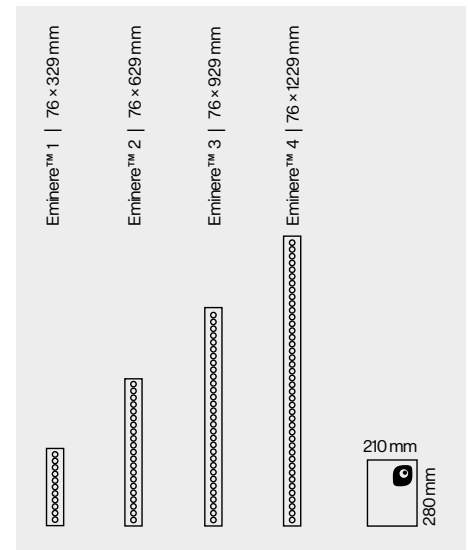

Product Variant



Finish Options

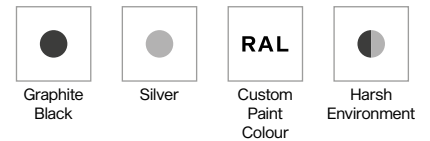

Optic Options

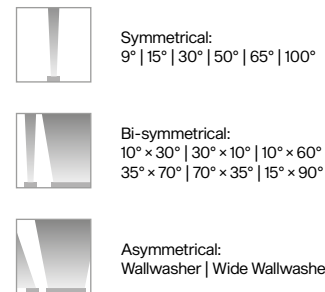

Control & Protocols

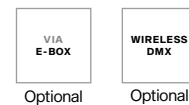

Standards and Certifications

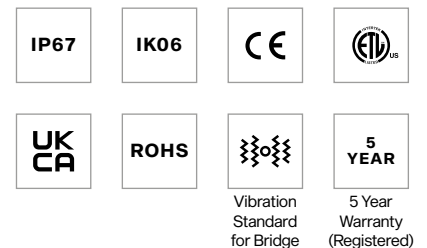

Eminere™ Side

Eminere Side is specifically designed for applications where a low form factor is required whilst keeping installation of the luminaire neat and clean. With only 76 mm in height, it keeps all of the Eminere series strengths. Wide range of optics options, durability, connectivity, application flexibility make this luminaire ideal solution for flood lighting, wall grazing, wall washing and accent lighting.



Quick and Easy Installation

Easy and quick installation using click-on connectors overmoulded on combo cable (Power + Data).

Durability

High durability of IK06 in combination of ingress factor IP67.

Application Flexibility

Complete solution for illuminating buildings, monuments, walls, statues, bridges, coves, arches and much more. With PSU on its side, Eminere Side is only 76 mm in height.

Optics & Colours

Wide range of optics allows to place product anywhere needed with no limitation. Full spectral LEDs selection with custom option on request. Output up to 1147 lm (RGBW) or 1652 lm (PW) per one foot of Eminere.

Scale

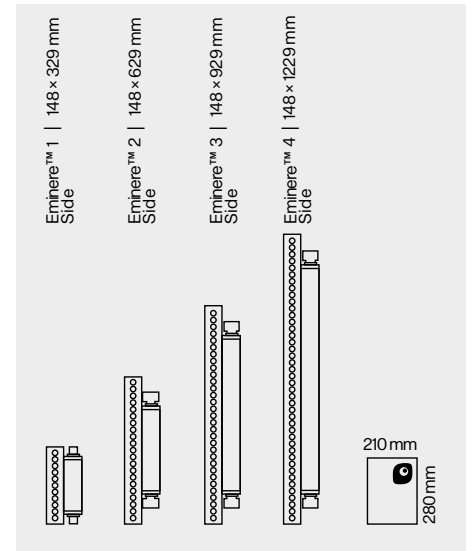

Product Variant



Finish Options

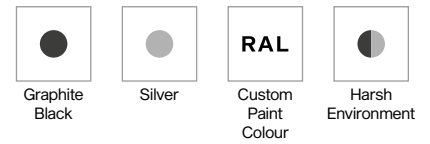

Optic Options

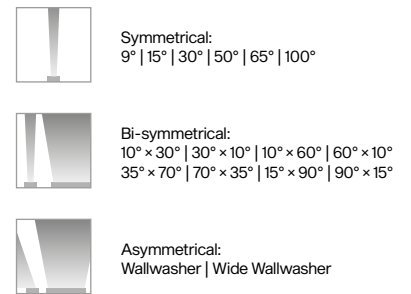

Control & Protocols

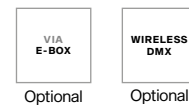

Standards and Certifications

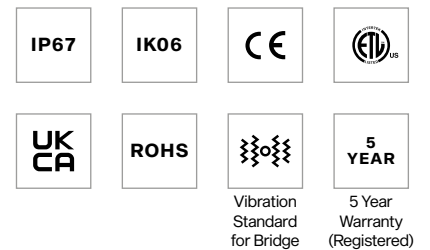

Eminere™ Inground

Eminere Inground is a robust luminaire designed to be installed into the ground. A stainless steel installation sleeve provides rust protection as well as "armour" for the Eminere fixture itself. Overall, Eminere Inground comes with an IP67 protection factor, standard or Anti-skid glass, and as always, perfect colour mixing. With $\pm 15^\circ$ tilt adjustment, precision optics with wide range of beam angles and colour variants, in-ground version of the Eminere luminaire is great choice for an exterior applications such as flood lighting, wall grazing, wall washing and accent lighting.



- Application** Anti-skid glass option for pedestrian areas application. Easy to install into soft and hard ground.
- Light Source** Full spectral LEDs selection with custom option on request. Output up to 2019 lm for Eminere Inground 2 RGBW. Long LED lifetime over 90,000 hrs. Manually adjustable tilt $\pm 15^\circ$ for fine adjustment of light beam.
- Durability** High durability with ingress factor of IP67 and walkover housing made from stainless steel with welded support for highest durability requirements.

Scale

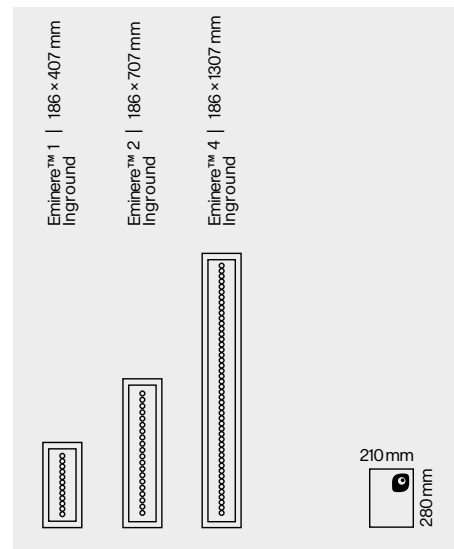

Product Variant



Finish Options



Optic Options

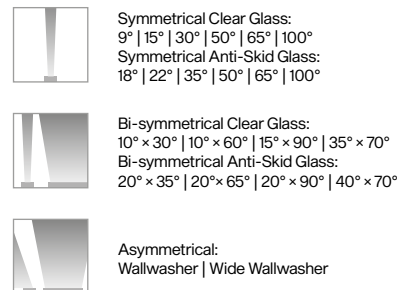

Control & Protocols

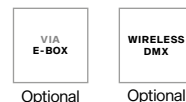

Standards and Certifications

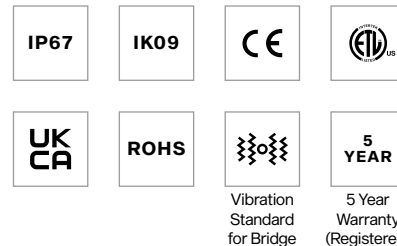

Eminere™ Remote

The newest member of the Eminere product range, Eminere Remote extends our series of linear architectural fixtures into further application possibilities using only low voltage for higher safety restrictions. Available in four sizes, ranging from 1 to 4 feet, Eminere Remote follows the identical optical and performance features of our other established and proven Eminere fixtures. Design-wise, Eminere Remote brings all of today's technology into an elegant and slim body, but is still very robust with an IP67 rating to withstand the harshest environments.



Scale

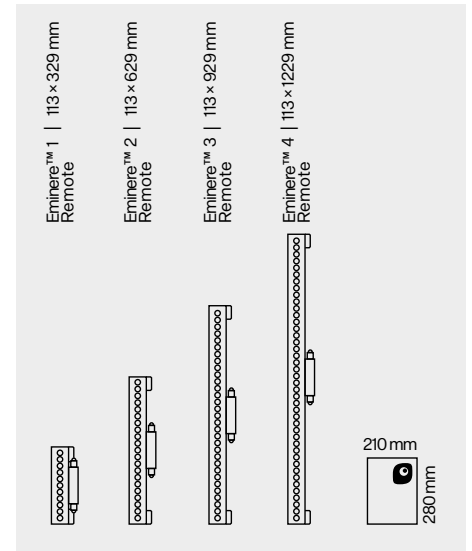

Optic & Control Output up to 1147 lm (RGBW) or 1652 lm (PW) per one foot of Eminere. With a wide range of optics for limitless fixture applications, Eminere Remote can also be operated in pixel (12 LEDs) or fixture modes, and its low-input voltages allow the luminaire to be used in applications with higher safety restrictions.

Compact Design At only 39 mm of total height, Eminere Remote is the thinnest lighting solution in our Eminere series and has been designed as a compact and slim LED luminaire suitable for any low-profile application.

Durability Thanks to its tempered glass and high-pressure, extruded aluminium housing, Eminere Remote is IK06 and IP67 certified. For more extreme and marine applications, a harsh environment finish option is also available.

Product Variant



Finish Options

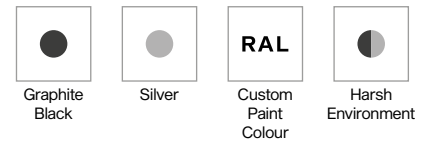

Optic Options

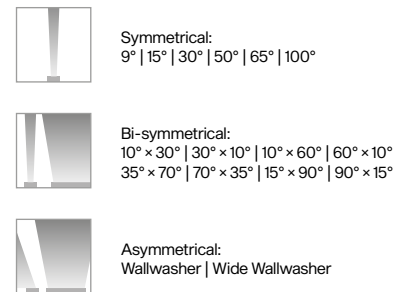

Control & Protocols



Standards and Certifications

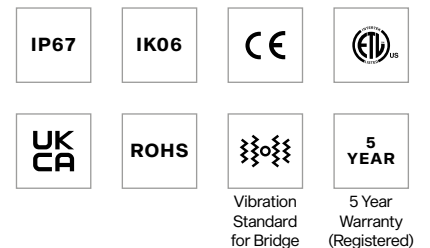

Eminere™ UV

An excellent solution for theme parks and entertainment venues where an attention grabbing UV effect is required, Eminere UV produces a true black light effect. Available in 2-foot or 4-foot models, Eminere UV evenly distributes UV output with a wavelength of 365 nm for a wide range of installations and designs. Utilising a powered E-Box, control for the Eminere UV is made possible over DMX (wired or wireless) or Ethernet protocols. Consistent with the design quality of the entire Anolis product portfolio, the Eminere UV range is robust and extremely durable with IP67 and IK06 ratings.



Scale

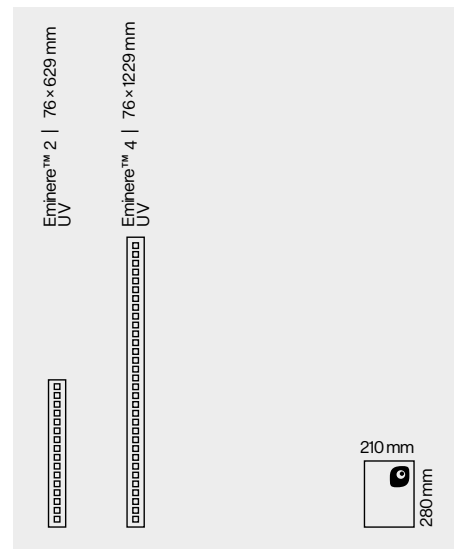

Optic & Control With a wavelength of 365 nm, Eminere UV provides UV black light using 10,000 hrs lifetime LEDs which can be powered by E-Box, and utilises DMX (wired or wireless) or ethernet protocols for control.

Physical Eminere UV is available in two physical models; 2-foot and 4-foot LED luminaires. All fixtures from our Eminere family are easily installed with the simplicity of a “plug and play” connection.

Durability Robust and durable, Eminere UV fulfills both IP67 and IK06 certification, backed by a 2 year warranty.

Product Variant



Finish Options



Optic Options



Optical version: 38°



Non-optical version: 120°

Control & Protocols



Standards and Certifications



Vibration Standard for Bridge

2 Year Warranty

Eminere™ Remote UV

An excellent solution for theme parks and entertainment venues where an attention-grabbing UV effect is required, Eminere Remote UV produces a true black light effect. Available in 1-foot, 2-foot or 4-foot models, Eminere Remote UV evenly distributes UV output with a wavelength of 365 nm for a wide range of installations and designs. Utilising a powered E-Box Remote, control for the Eminere Remote UV is made possible over DMX (hard-wired or wireless) or Ethernet protocols. Consistent with the design quality of the entire Anolis product portfolio, the Eminere Remote UV range is robust and extremely durable with IP67 and IK06 ratings.



Scale

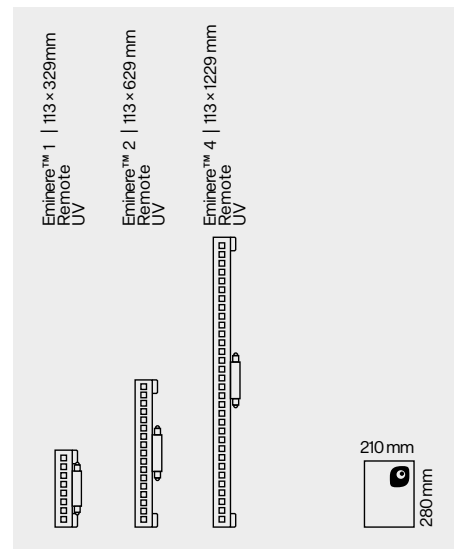

Optic & Control With a wavelength of 365 nm, Eminere Remote UV provides UVA black light using 10,000 hrs lifetime LEDs which can be powered by E-Box Remote range and utilises DMX (wired or wireless) or ethernet protocols for control.

Physical Eminere Remote UV is available in three physical models; 1-foot, 2-foot and 4-foot LED luminaires. At only 39 mm of total height, Eminere Remote is suitable for any low-profile application.

Durability Robust and durable, Eminere Remote UV fulfills both IP67 and IK06 certification, backed by a 2 year warranty.

Product Variant



UV

Finish Options



Graphite Black



Silver



Custom Paint Colour



Harsh Environment

Optic Options



Optical version: 38°



Non-optical version: 120°

Control & Protocols



Optional

Standards and Certifications



Vibration Standard for Bridge



2 Year Warranty

Anolis Lighting
Outdoor

Introduction

Lava Tunnel, Iceland



Calumma™ series





Brand new in every dimension

The Calumma Series was built to continue the success of the ArcSource family and to be the new industry standard. Floodlights designed to be powerful, efficient and well-rounded to provide great light output for various applications. Calumma luminaires have durability for harsh outdoor environment and beautiful design, that will complement indoor applications as well. With a wide range of options to choose from makes this series a very valuable unit in lighting designer toolbox.



As we said,
brand new...





ele





Plant



with
Calumma™



Calumma™ series



Calumma™ XS MC

40–41

184



Calumma™ S MC

42–43

186



Calumma™ M MC

44–45

188

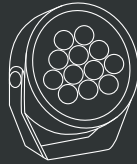

Calumma™ L MC

46–47

190

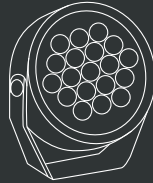

Calumma™ XL MC

48–49

192



Calumma™ S SC

50–51

194



Calumma™ M SC

52–53

196



Calumma™ L SC

54–55

198



Calumma™ XL SC

56–57

200

Calumma™ XS MC

Using a single high-power, multi-chip LED inside a compact, elegant, and durable housing, the smallest Calumma is a great choice for many different lighting applications. Complementing both outdoor environments and interior designs, its wide range of beam angles, LED chip colour variant options and accessories make the Calumma XS MC an ideal, extra small lighting solution for any architectural design.



Scale

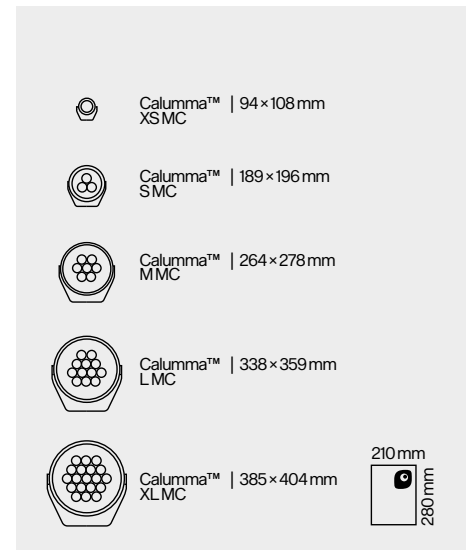

Lumen Output & Light Source

Luminaire with one high-power, multi-chip LED provides light output up to 415 lumens with an efficacy of 41 lm/w. Offering a choice of multiple LED colour variants, precise beam control with no light spill, and perfectly homogenised light output, it's an excellent solution for applications requiring high performance in a compact luminaire.

Design & Durability

Lightweight, compact, durable and stylish housing made of high-pressure die cast aluminium. IP67 and IK10 certification; suitable for marine and traffic applications. Supported with a 5 year warranty.

Flexibility

An exceptionally compact luminaire available with a wide range of accessories, custom colour finishes, LED choices, and beam angle options, Calumma XS offers the lighting designer a flexible solution for the most demanding applications.

Product Variant



Finish Options

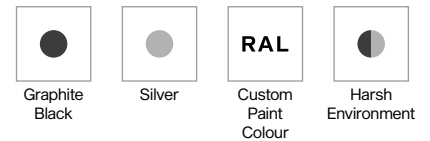

Optic Options

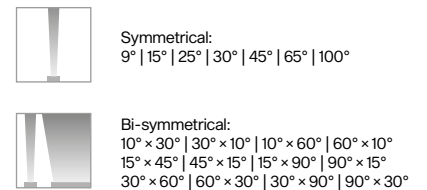

Control & Protocols



Optional

Standards and Certifications

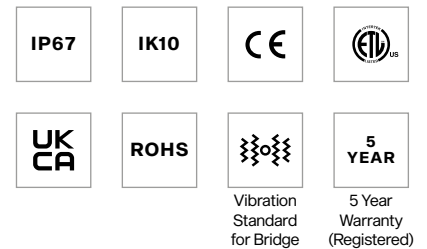

Calumma™ S MC

Featuring an optical design using three high efficacy multi-chip LEDs and available with optional LED colour variants and various beam angles, the medium-sized Calumma S MC luminaire creates powerful and beautiful light output for a spot, accent or flood lighting solution. Its durable housing is built to withstand any exterior conditions, and its special finish for harsh and marine environments provides an exceptional outdoor LED luminaire in an elegant design. Complemented by a wide range of accessories, control protocols and connection options, this luminaire is an effective and versatile unit to get the most out of architectural lighting applications.



Scale

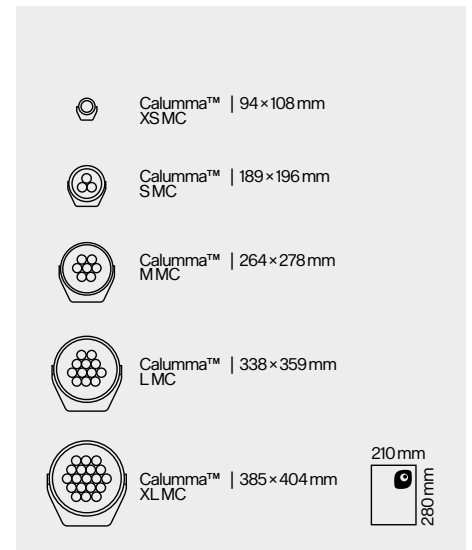

Product Variant



Finish Options

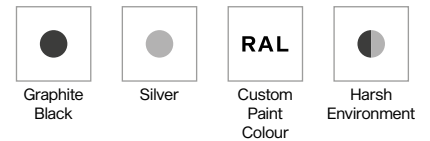

Optic Options

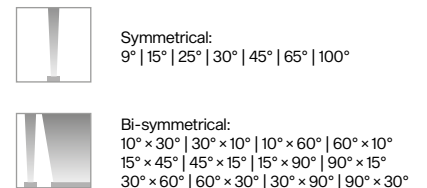

Control & Protocols



Standards and Certifications

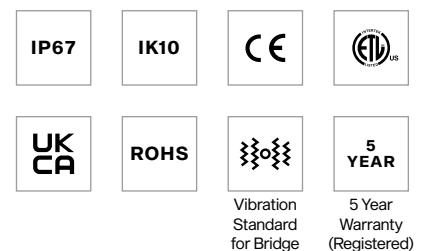

Lumen Output & Light Source	<p>Luminaire with three high-power, multi-chip LEDs provides up to 1245 lumen output. Multiple LED colour variants. No light spills. Perfectly homogenised light output with efficacy up to 41 lm/w.</p>
Design & Durability	<p>Compact, durable and stylish housing made of high-pressure die cast aluminium. IP67 and IK10 certification; suitable for marine and traffic applications. Supported with a 5 year warranty.</p>
Flexibility	<p>Exceptional outdoor or indoor LED luminaire with a wide range of accessories, custom colour finishes, multiple light output variants and beam angles.</p>
Connectivity	<p>Calumma SMC can be connected in long In/Out daisy chains via an E-Box and hybrid Plug & Play connections for almost effortless installation. DMX512+RDM and wide range of Ethernet protocols are available for E-Box control. DMX/RDM or DALI 2 interface protocols facilitate standard connection options.</p>

Calumma™ M MC

Featuring an optical design using 7 high efficacy multi-chip LEDs and available with optional LED colour variants and various beam angles, the medium-sized Calumma M MC luminaire creates powerful and beautiful light output for a spot, accent or flood lighting solution. Its durable housing is built to withstand any exterior conditions, and its special finish for harsh and marine environments provides an exceptional outdoor LED luminaire in an elegant design. Additionally, Calumma M MC can be connected in long In/Out daisy chains via an E-Box and hybrid Plug & Play connections for almost effortless installation. Complemented by wide range of accessories and control protocols, this luminaire is an effective and versatile unit to get the most out of architectural lighting applications.



Scale

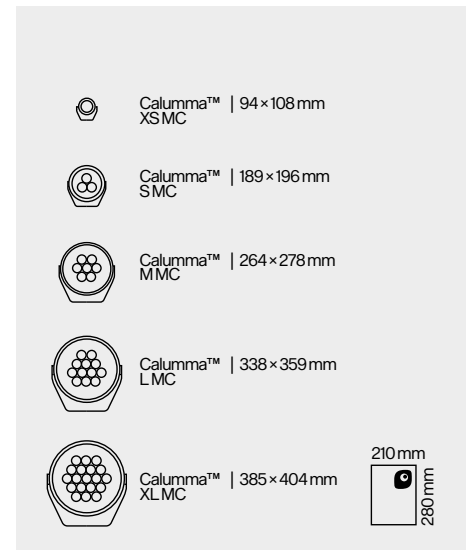

Lumen Output & Light Source

Luminaire with seven high-power, multi-chip LEDs provides up to 2906 lumen output. Multiple LED colour variants. No light spills. Perfectly homogenised light output with efficacy up to 41 lm/w.

Design & Durability

Compact, durable and stylish housing made of high-pressure die cast aluminium. IP67 and IK10 certification; suitable for marine and traffic applications. Supported with a 5 year warranty.

Flexibility

Exceptional outdoor or indoor LED luminaire with a wide range of accessories, custom colour finishes, multiple light output variants and beam angles.

Connectivity

Utilising the innovative E-Box series of power and data interfaces, Calumma MMC can communicate via numerous wired, wireless, and Ethernet-based control protocols. Various wiring topologies are supported using hybrid power / data cables with Plug & Play connectors or standard connection options.

Product Variant



Finish Options

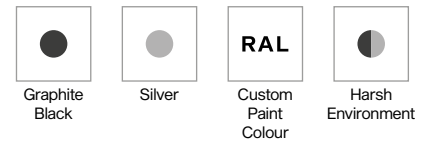

Optic Options

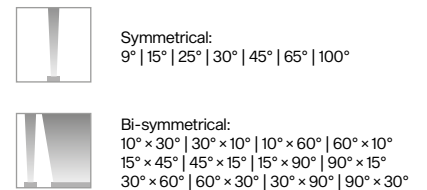

Control & Protocols

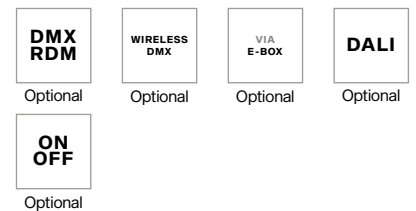

Standards and Certifications

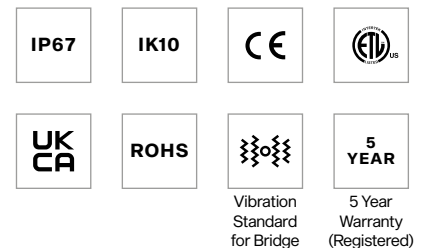

Calumma™ L MC

Featuring an optical design using twelve high efficacy multi-chip LEDs and available with optional LED colour variants and various beam angles, the medium-sized Calumma L MC luminaire creates powerful and beautiful light output for a spot, accent or flood lighting solution. Its durable housing is built to withstand any exterior conditions, and its special finish for harsh and marine environments provides an exceptional outdoor LED luminaire in an elegant design. Additionally, Calumma L MC can be connected in long In/Out daisy chains via an E-Box and hybrid Plug & Play connections for almost effortless installation. Complemented by wide range of accessories and control protocols, this luminaire is an effective and versatile unit to get the most out of architectural lighting applications.



Scale

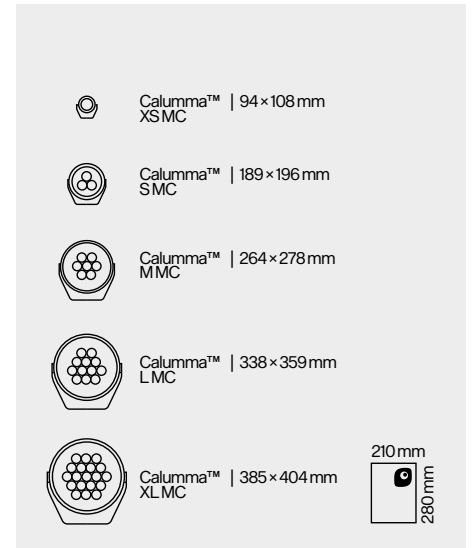

Lumen Output & Light Source

Luminaire with twelve high-power, multi-chip LEDs provides up to 4983 lumen output. Multiple LED colour variants. No light spills. Perfectly homogenised light output with efficacy up to 39 lm/w.

Design & Durability

Compact, durable and stylish housing made of high-pressure die cast aluminium. IP67 and IK10 certification; suitable for marine and traffic applications. Supported with a 5 year warranty.

Flexibility

Exceptional outdoor or indoor LED luminaire with a wide range of accessories, custom colour finishes, multiple light output variants and beam angles.

Connectivity

Utilising the innovative E-Box series of power and data interfaces, Calumma L MC can communicate via numerous wired, wireless, and Ethernet-based control protocols. Various wiring topologies are supported using hybrid power / data cables with Plug & Play connectors or standard connection options.

Product Variant



Finish Options

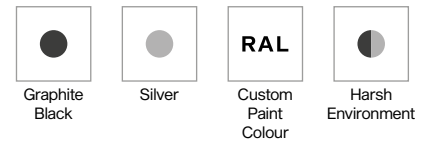

Optic Options

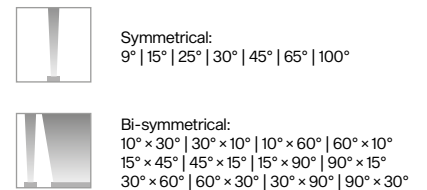

Control & Protocols

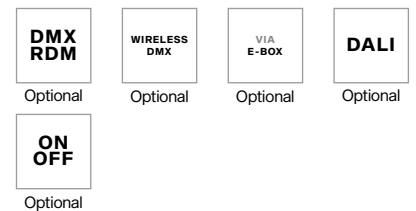

Standards and Certifications

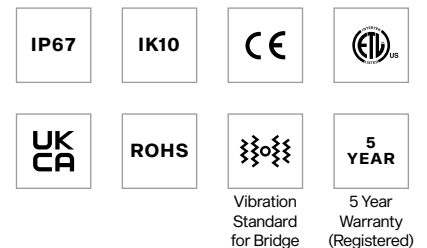

Calumma™ XL MC

Featuring an optical design using nineteen high efficacy multi-chip LEDs and available with optional LED colour variants and various beam angles, the medium-sized Calumma XL MC luminaire creates powerful and beautiful light output for a spot, accent or flood lighting solution. Its durable housing is built to withstand any exterior conditions, and its special finish for harsh and marine environments provides an exceptional outdoor LED luminaire in an elegant design. Additionally, Calumma XL MC can be connected in long In/Out daisy chains via an E-Box and hybrid Plug & Play connections for almost effortless installation. Complemented by wide range of accessories and control protocols, this luminaire is an effective and versatile unit to get the most out of architectural lighting applications.



Lumen Output & Light Source	<p>Luminaire with nineteen high-power, multi-chip LEDs provides up to 7889 lumen output. Multiple LED colour variants. No light spills. Perfectly homogenised light output with efficacy up to 46 lm/w.</p>
Design & Durability	<p>Compact, durable and stylish housing made of high-pressure die cast aluminium. IP67 and IK10 certification; suitable for marine and traffic applications. Supported with a 5 year warranty.</p>
Flexibility	<p>Exceptional outdoor or indoor LED luminaire with a wide range of accessories, custom colour finishes, multiple light output variants and beam angles.</p>
Connectivity	<p>Utilising the innovative E-Box series of power and data interfaces, Calumma XL MC can communicate via numerous wired, wireless, and Ethernet-based control protocols. Various wiring topologies are supported using hybrid power / data cables with Plug & Play connectors or standard connection options.</p>

Scale

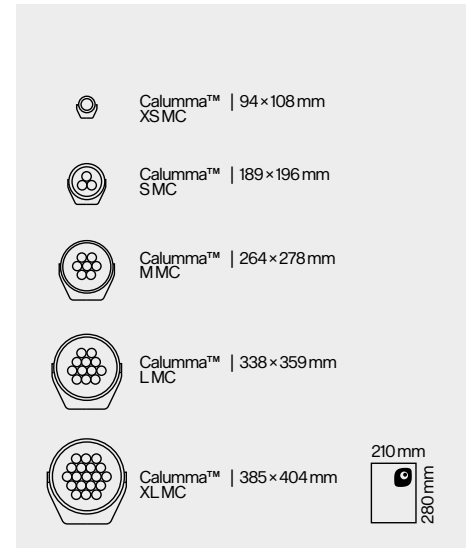

Product Variant



Finish Options

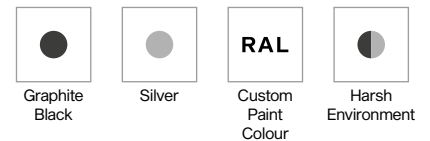

Optic Options

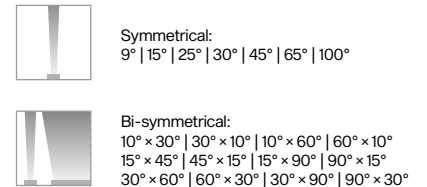

Control & Protocols

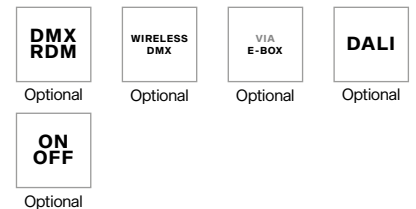

Standards and Certifications

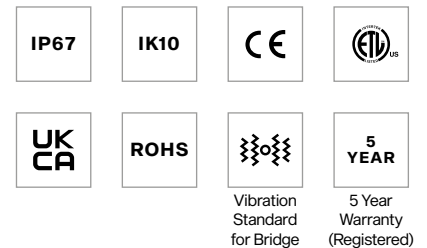

Calumma™ S SC

Featuring an optical design using nineteen high efficacy single-chip LEDs and available with optional LED colour variants and various beam angles, the medium-sized Calumma S SC luminaire creates powerful and beautiful light output for a spot, accent or flood lighting solution. Its durable housing is built to withstand any exterior conditions, and its special finish for harsh and marine environments provides an exceptional outdoor LED luminaire in an elegant design. Complemented by wide range of accessories, control protocols and connection options, this luminaire is an effective and versatile unit to get the most out of architectural lighting applications.



Scale

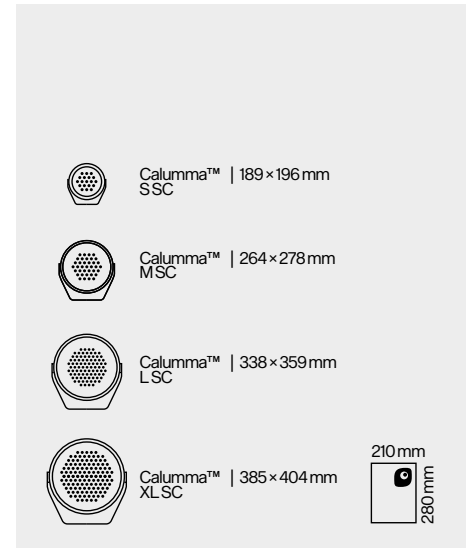

Lumen Output & Light Source

Luminaire with nineteen high-power, single-chip LEDs provides up to 1780 lumen output (@10°, RGBW). Multiple LED colour variants. No light spills. Well homogenised light output with great efficacy up to 59 lm/w.

Design & Durability

Compact, durable and stylish housing made of high-pressure die cast aluminium. IP67 and IK10 certification; suitable for marine and traffic applications. Supported with a 5 year warranty.

Flexibility

Exceptional outdoor or indoor LED luminaire with a wide range of accessories, custom colour finishes, multiple light output variants and beam angles.

Connectivity

Calumma S SC can be connected in long In/Out daisy chains via an E-Box and hybrid Plug & Play connections for almost effortless installation. DMX512 + RDM and wide range of Ethernet protocols are available for E-Box control. DMX/RDM or DALI 2 interface protocols facilitate standard connection options.

Product Variant



Finish Options

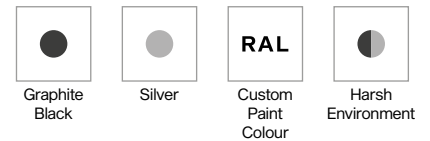

Optic Options

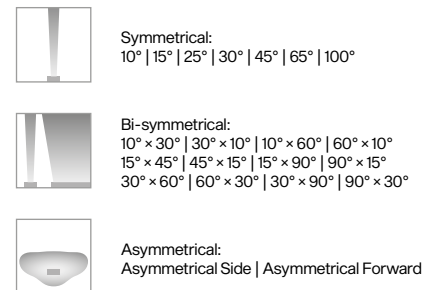

Control & Protocols



Standards and Certifications

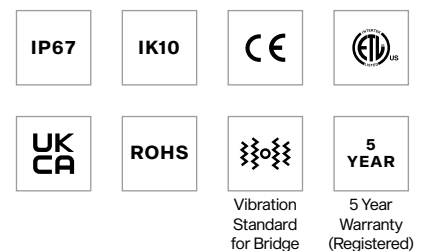

Calumma™ MSC

Featuring an optical design using 37 high efficacy single-chip LEDs and available with optional LED colour variants and various beam angles, the medium-sized Calumma MSC luminaire creates powerful and beautiful light output for a spot, accent or flood lighting solution. Its durable housing is built to withstand any exterior conditions, and its special finish for harsh and marine environments provides an exceptional outdoor LED luminaire in an elegant design. Additionally, Calumma MSC can be connected in long In/Out daisy chains via an E-Box and hybrid Plug & Play connections for almost effortless installation. Complemented by wide range of accessories and control protocols, this luminaire is an effective and versatile unit to get the most out of architectural lighting applications.



Scale

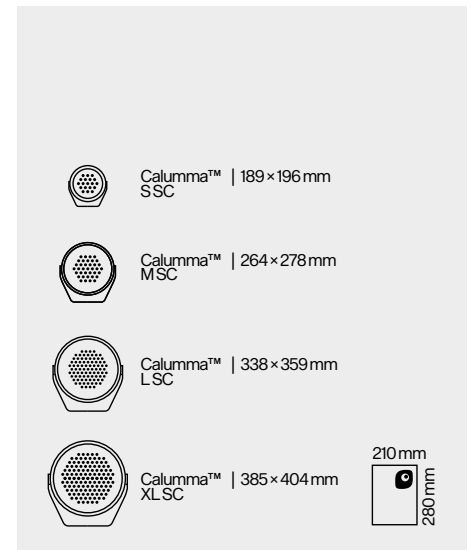

Lumen Output & Light Source

Luminaire with 37 high-power, single-chip LEDs provides up to 3466 lumen output. Multiple LED colour variants. No light spills. Well homogenised light output with great efficacy up to 57 lm/w.

Design & Durability

Compact, durable and stylish housing made of high-pressure die cast aluminium. IP67 and IK10 certification; suitable for marine and traffic applications. Supported with a 5 year warranty.

Flexibility

Exceptional outdoor or indoor LED luminaire with a wide range of accessories, custom colour finishes, multiple light output variants and beam angles.

Connectivity

Utilising the innovative E-Box series of power and data interfaces, Calumma MSC can communicate via numerous wired, wireless, and Ethernet-based control protocols. Various wiring topologies are supported using hybrid power / data cables with Plug & Play connectors or standard connection options.

Product Variant



Finish Options

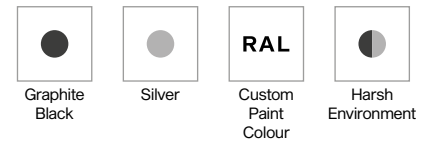

Optic Options

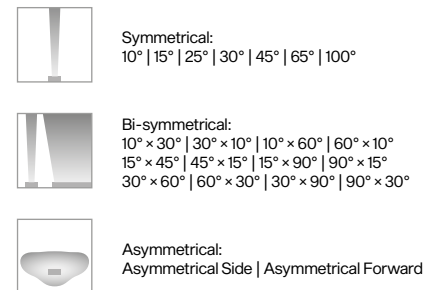

Control & Protocols

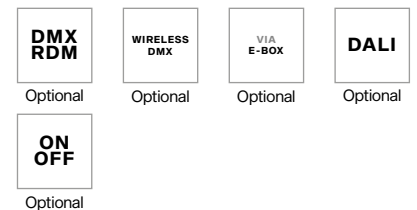

Standards and Certifications

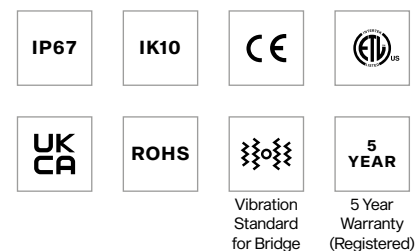

Calumma™ L SC

Featuring an optical design using 85 high efficacy single-chip LEDs and available with optional LED colour variants and various beam angles, the large-sized Calumma L SC luminaire creates powerful and beautiful light output for a spot, accent or flood lighting solution. Its durable housing is built to withstand any exterior conditions, and its special finish for harsh and marine environments provides an exceptional outdoor LED luminaire in an elegant design. Additionally, Calumma L SC can be connected in long In/Out daisy chains via an E-Box and hybrid Plug & Play connections for almost effortless installation. Complemented by wide range of accessories and control protocols, this luminaire is an effective and versatile unit to get the most out of architectural lighting applications.



Scale

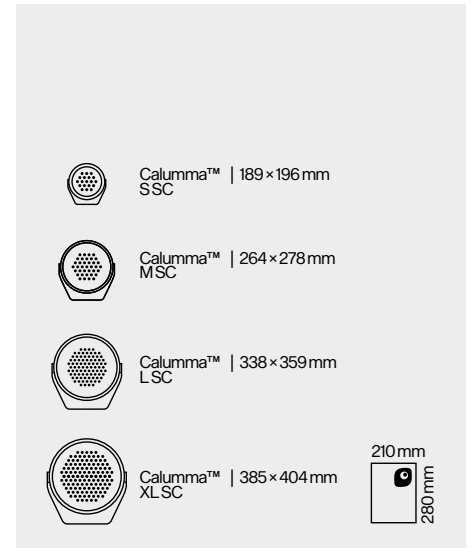

Lumen Output & Light Source

Luminaire with 85 high-power, single-chip LEDs provides up to 7962 lumen output. Multiple LED colour variants. No light spills. Well homogenised light output with great efficacy up to 63 lm/w.

Design & Durability

Compact, durable and stylish housing made of high-pressure die cast aluminium. IP67 and IK10 certification; suitable for marine and traffic applications. Supported with a 5 year warranty.

Flexibility

Exceptional outdoor or indoor LED luminaire with a wide range of accessories, custom colour finishes, multiple light output variants and beam angles.

Connectivity

Utilising the innovative E-Box series of power and data interfaces, Calumma L SC can communicate via numerous wired, wireless, and Ethernet-based control protocols. Various wiring topologies are supported using hybrid power / data cables with Plug & Play connectors or standard connection options.

Product Variant



Finish Options

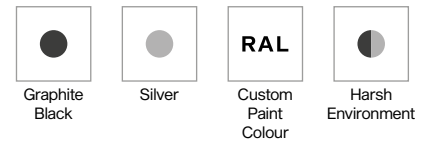

Optic Options

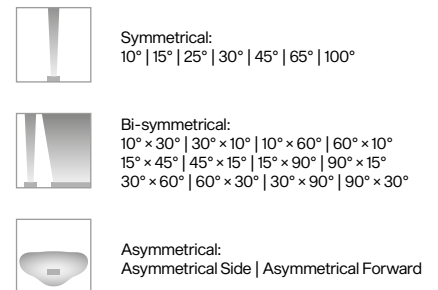

Control & Protocols

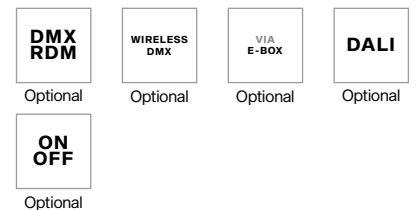

Standards and Certifications

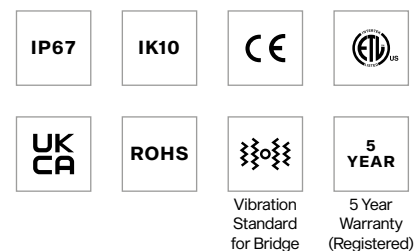

Calumma™ XL SC

Featuring an optical design using 121 high efficacy single-chip LEDs and available with optional LED colour variants and various beam angles, the medium-sized Calumma XL SC luminaire creates powerful and beautiful light output for a spot, accent or flood lighting solution. Its durable housing is built to withstand any exterior conditions, and its special finish for harsh and marine environments provides an exceptional outdoor LED luminaire in an elegant design. Additionally, Calumma XL SC can be connected in long In/Out daisy chains via an E-Box and hybrid Plug & Play connections for almost effortless installation. Complemented by wide range of accessories and control protocols, this luminaire is an effective and versatile unit to get the most out of architectural lighting applications.



Scale

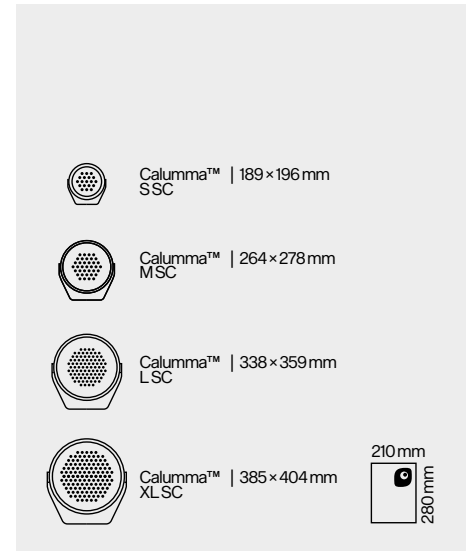

Lumen Output & Light Source

Luminaire with 121 high-power, single-chip LEDs provides up to 11,335 lumen output. Multiple LED colour variants. No light spills. Well homogenised light output with great efficacy up to 66 lm/W.

Design & Durability

Compact, durable and stylish housing made of high-pressure die cast aluminium. IP67 and IK10 certification; suitable for marine and traffic applications. Supported with a 5 year warranty.

Flexibility

Exceptional outdoor or indoor LED luminaire with a wide range of accessories, custom colour finishes, multiple light output variants and beam angles.

Connectivity

Utilising the innovative E-Box series of power and data interfaces, Calumma XL SC can communicate via numerous wired, wireless, and Ethernet-based control protocols. Various wiring topologies are supported using hybrid power / data cables with Plug & Play connectors or standard connection options.

Product Variant



Finish Options

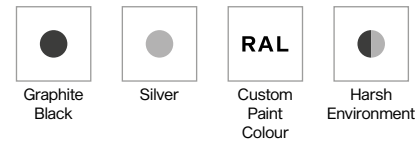

Optic Options

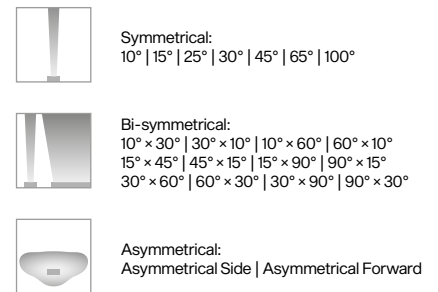

Control & Protocols

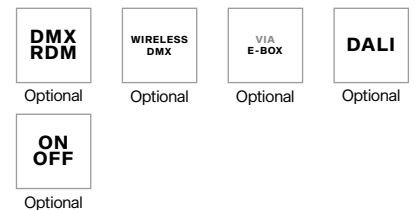

Standards and Certifications

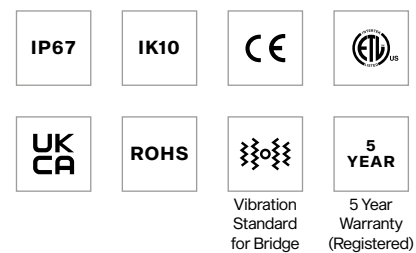



Divine™ series





Bringing lights

The Anolis luminaires utilise the latest LEDs for single and multi-chip devices in all colour specification and a wide range of beam angles. The Divine series brings perfect lighting solutions for large scale building exteriors and façades due to the phenomenal light output. Find the way to illuminate diverse locations with various mounting options and accessories. Divines are designed to withstand the toughest weather conditions at the most demanding applications.



Kauffman Center, USA
—
Divine™ 72

The Kauffman Center for the Performing Arts was designed by Moshe Safdie and is home to the Kansas City Ballet, Lyric Opera of Kansas City and Kansas City Symphony as well as heralded as one of the World's 15 Most Beautiful Concert Halls. Wanting to update the exterior lighting design to better illuminate and accentuate the incredible architecture, the Kauffman Center worked with Lankford Fendler + Associates who created a new lighting design using Anolis products supplied by Premier Lighting and Controls.

to challenging locations



Dream
big



with
Divine™



Divine™ series

Product
Type

Product Overview
Page Number

Technical Specification
Page Number



Divine™ 160

66–67

202



Divine™ 72

68–69

204



Divine™ 60 UV

70–71

206

Divine™ 160

The Divine 160 is a high-performance 440W luminaire with phenomenal light output that can be used for a variety of architectural lighting scenarios including the application of dynamic colour changing effects to building exteriors and façades, or illuminating complete areas with subtle CCT controllable white light. The Divine is available in numerous configuration options including optics for flood or accent lighting. RGBW, RGBA or PureWhite in a variety of colour temperatures combined with different mounting options and accessories make Divine a truly flexible solution.



Physical	With a compact and lightweight construction fulfilling IP67 and IK10 certifications, the Divine 160 multi-chip optical system delivers superb light with enhanced 18-bit control.
Lumen Output & Light Source	Providing an output up to 11,836 lm, the fixture utilises 40 high-power multi-chip LEDs.
Projected Lumen Maintenance	The long 90,000 hrs LED lifetime make Divine 160 an ideal choice for long-term lighting applications.
Power Consumption	Typical power consumption of the luminaire is 440 W.

Scale

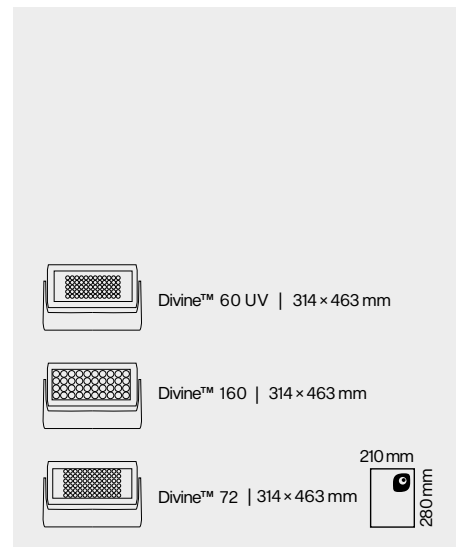

Product Variant



Finish Options

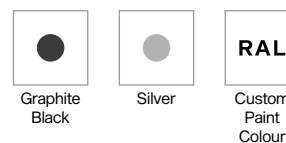

Optic Options

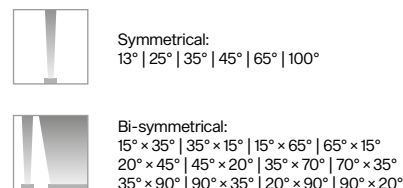

Control & Protocols

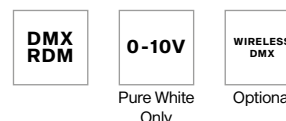

Standards and Certifications

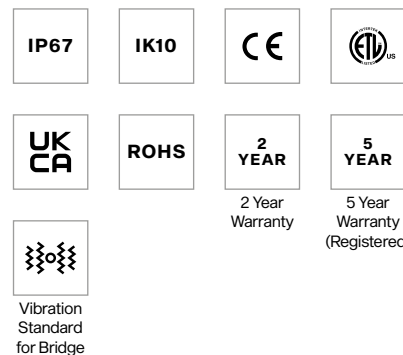

Divine™ 72

The latest fixture in the Divine range, the Divine 72 features cutting-edge Zero Passive technology to eliminate light over-spill with our most precise optics to date. Specifically developed to optimise the beam for long throw applications, the native 6° beam angle delivers an impressive 6573 lx at 10 metres. Backed by a 5 year warranty and an IP67 rating, this unit has been designed for the rigours of extreme weather, and with flexible mounting options and accessories it can be installed on the most demanding projects.



Physical Optimised for long throw applications, patented beam control technology eliminates light spill.

Lumen Output & Light Source 72 high power LEDs provide up to 10,228 lm flux when RGBW colour configuration and 6° optics are used.

Projected Lumen Maintenance The long 90,000 hrs LED lifetime makes Divine 72 an ideal choice for long-term lighting applications.

Power Consumption Power consumption is only 325 W when operating at full power.

Scale

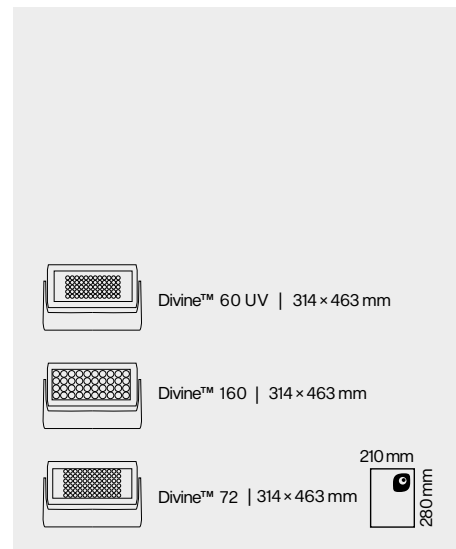

Product Variant

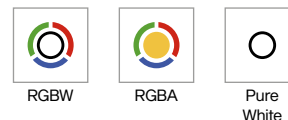

Finish Options

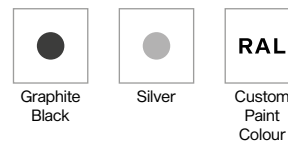

Optic Options

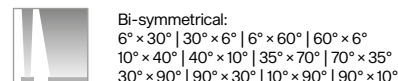
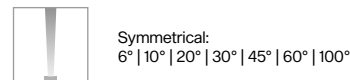

Control & Protocols

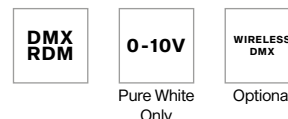

Standards and Certifications

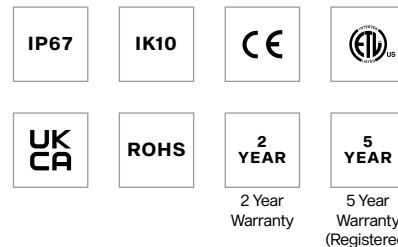

Divine™ 60 UV

Excellent for theme parks, attractions, leisure facilities and entertainment venues that require a true UV “black light” effect, both indoors and outdoors, this 180 Watt full LED luminaire produces high UV output levels at a 365 nm wavelength. Built-in DMX and RDM control enables precise lighting levels and the wireless control option allows retrofitting into existing installations without additional infrastructure. All the components are rated UV-stable and housed inside an IP67 rated casing, tough enough for the most challenging applications.



Key Features	Almost undetectable luminescence at normal lighting frequencies. Powerful output for indoor & outdoor effects.
Light Source	Light output is provided by 60 UV LEDs with 16,000 hrs (L70@25 °C / 77 °F) projected lumen maintenance.
Power Consumption	Typical power consumption of the luminaire is 180 W ±10 %.
Physical	Divine 60 UV fulfills an IP67 rating and is suitable for wet locations.
Control	Any third-party DMX controller can be used to control Divine 60 UV.

Scale

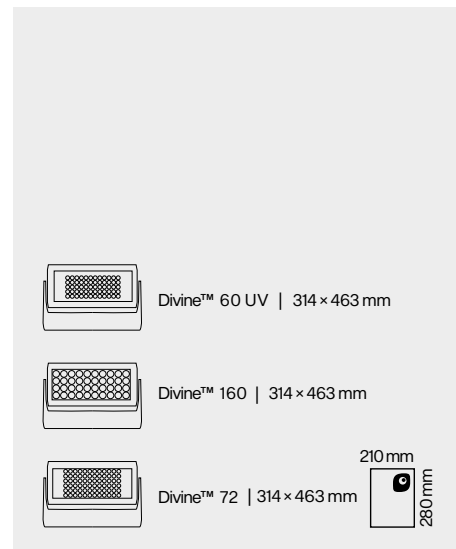

Product Variant



Finish Options

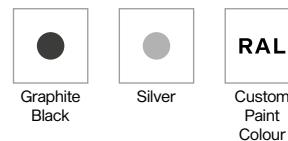

Optic Options



Control & Protocols

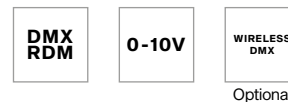

Standards and Certifications

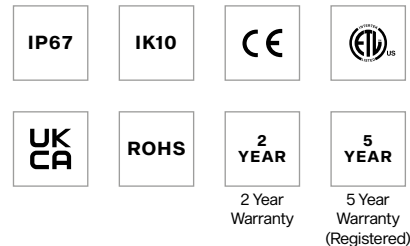



Arc™ series

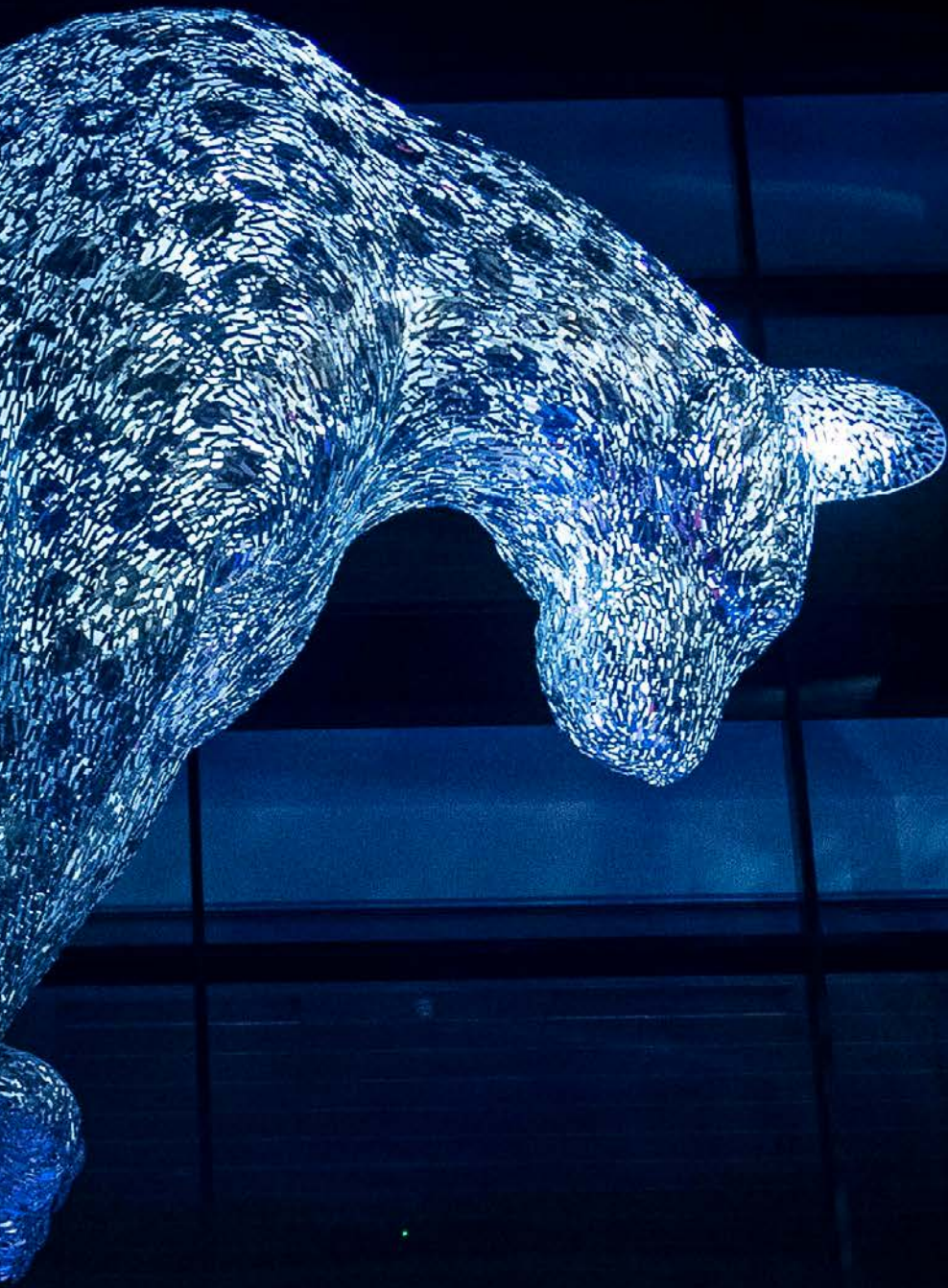



Les Bassins de Lumières, France
—
ArcSource™ Outdoor

The Arc series includes various luminaires for many different applications. With submersible, inground, zoomable and direct-view units it complements other series by Anolis and helps to find the best lighting solution.

Seam

Cascades Gardens, South Africa
—
ArcSource™ Submersible II



ables

Take a closer
look







Arc™ series

Product
Type

Product Overview
Page Number

Technical Specification
Page Number



ArcSource™ Inground 24MC Integral

80–81

208



ArcSource™ Submersible II

82–83

210



ArcPar™ 150 Outdoor

84–85

212



ArcDot™

86–87

214



ArcPix™ II

88–89

216

ArcSource™ Inground 24MC Integral

Difficult inground installations are made easier with the ArcSource Inground 24MC Integral. The fixture only requires mains power when combined with the wireless control capability – drastically reducing installation time and cost. High light output comes from six powerful multi-chip LEDs and it can be used with a variety of optics, from narrow to wide, in addition to an asymmetrical option. The light source can be remotely tilted $\pm 15^\circ$ from the horizontal position, always ensuring accurate illumination of the selected surface. Additionally, ArcSource Inground 24MC Integral can be equipped with anti-skid glass featuring the highest standards of certification for anti-slip usage having no impact on the fixture's outstanding colour mixing.



Key Features	Inground light source – integrated electronics & remote adjustable beam position.
Lumen Output & Light Source	Providing perfectly mixed colour with luminous flux up to 1542 lm, the 65W ArcSource Inground 24MC Integral luminaire utilises RGBW LED Multi-chips with 7° optics. Its excellent lumen maintenance of 90,000 hrs (L90B10) provides a dependable and long-term lighting installation.
Physical	Protected underground by high-pressure, die-cast aluminium, the above-ground stainless steel and glass cover provides an elegant and durable lighting solution in all kind of weather. The glass cover can be clear for wall and ceiling installations, or with anti-skid treatment for in-ground applications, and its durability is guaranteed by IP68 and IK10 certification.

Scale

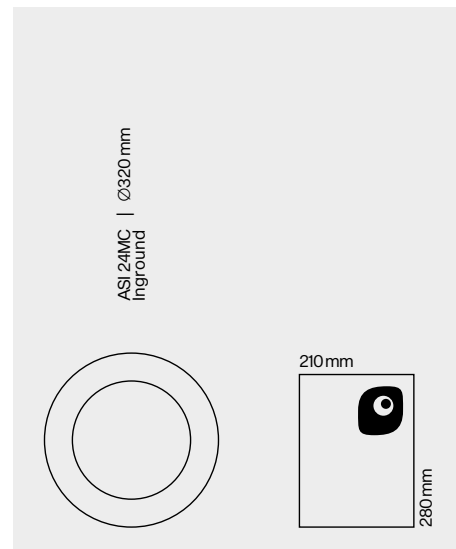

Product Variant



Finish Options



Optic Options



Symmetrical:
Clear Glass: 7° | 24° | 34°
Anti-Skid Glass: 16° | 28° | 33°



Bi-symmetrical
Clear Glass: 7° x 42° | 42° x 7°
Anti-Skid Glass: 16° x 42° | 42° x 16°

Control & Protocols



Standards and Certifications



5 Year
Warranty
(Registered)

ArcSource™ Submersible II

Architectural lighting sometimes brings specific requirements for fixture positioning which might be hard to comply with for 99% of the products on the market. With an extremely durable body, crafted from bronze to withstand the most challenging environmental conditions, Anolis Lighting introduces ArcSource Submersible II. Utilising a standard LED colour set-up that can be customised to meet individual installation specifications, ArcSource Submersible II can easily operate constantly submersed up to 10 m and offers more than 10 different beam options for positioning freedom.



Scale

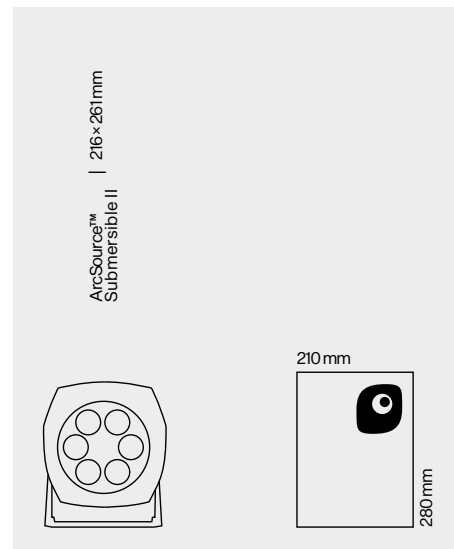

Lumen Output & Light Source

With only a 100 W power consumption, the ArcSource Submersible II provides well-mixed luminous flux 2235 lm thanks to its six multi-chip LEDs.

Lifetime

Its 90,000 hrs (L90B10) LED lifetime makes it an ideal low working-cost solution for submersed applications.

Physical

The unique construction of this LED luminaire allows it to be temporarily up to 10 m (32.81 ft.) under water. Its IP68 and IK10 rated housing is made from marine bronze to resist the corrosive effects of unfriendly environments, and the lenses are protected by tempered glass.

Product Variant

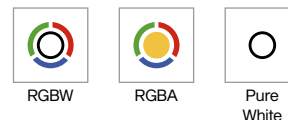

Finish Options



Optic Options



Symmetrical:
7° | 13° | 20° | 30° | 40° | 60° | 90° |



Bi-symmetrical:
7° x 30° | 30° x 7° | 7° x 60° | 60° x 7° |
35° x 70° | 70° x 35° | 10° x 90° | 90° x 10° |

Control & Protocols



Standards and Certifications

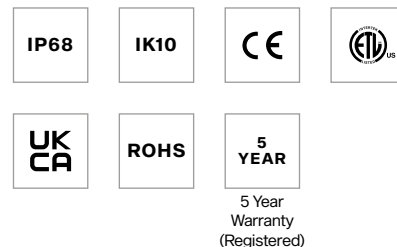

ArcPar™ 150 Outdoor

Designed with an all-in-one, approach the ArcPar 150 Outdoor makes installation smoother by allowing last minute tweaks and modifications on-site. The versatility of this unique product shines through with the introduction of its optical system which has a zoom ratio of 15,5:1 while an approximate range of 3.8°–60° makes ArcPar 150 Outdoor ideal for flood or spot lighting. The ArcPar 150 Outdoor has an IP 65 rating and is suitable for wet locations. As always, Anolis' signature quality colour mixing is present, easily selectable through a virtual colour wheel, preset with over 60 colour options. ArcPar 150 Outdoor has ROBE's innovative lens coating technology with benefits including bright and clear lenses, no scratches or marks, higher light output and longer intervals between cleaning.



Scale

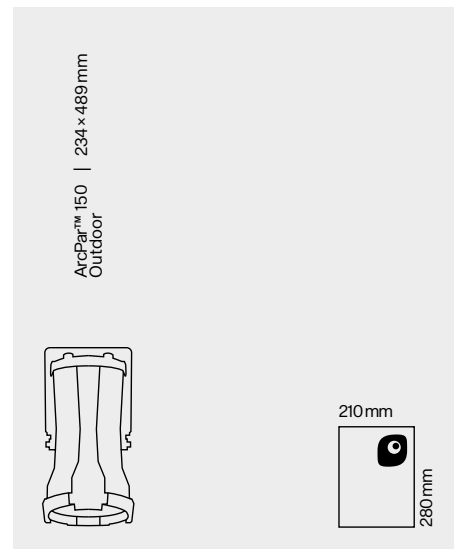

Key Features	IP65 rated outdoor colour changing high power LED fixture with remote 3.8°–60° zoom.
Lumen Output & Light Source	Lumen output of 1676 lm is provided by seven high-power multi-chip LEDs.
Projected Lumen Maintenance	The projected lumen maintenance is 90,000 hrs (L90B10).
Power Consumption	220 W energy consumption provides excellent efficiency at low operating costs.
Physical	The durable cast aluminium body with lenses covered by tempered glass is a stylish, durable and easy-to-mount solution. The fixture's physical dimensions are 228 × 234 × 412 mm (8.97 × 9.21 × 17.64 in) and it weighs 7.92 kg (17.46 lbs).

Product Variant



Finish Options

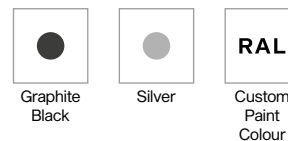

Optic Options

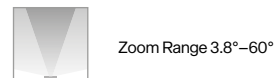

Control & Protocols



Standards and Certifications

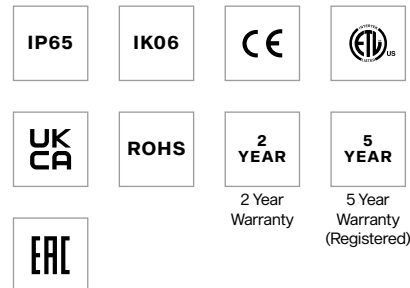

ArcDot™

Excellent for large scale matrix applications due to its advanced pixel mapping capabilities, the ArcDot uses a Cree MC-E RGBW Multi-chip with high light output that features a built-in intelligent electronic control system. This guarantees flicker-free operation and overheating protection whilst remote addressing, calibration and status messaging is also included. Built to an IP67 rating ensures the unit is capable of withstanding tough weather conditions but is also perfect for a wide variety of interior installations.



Scale

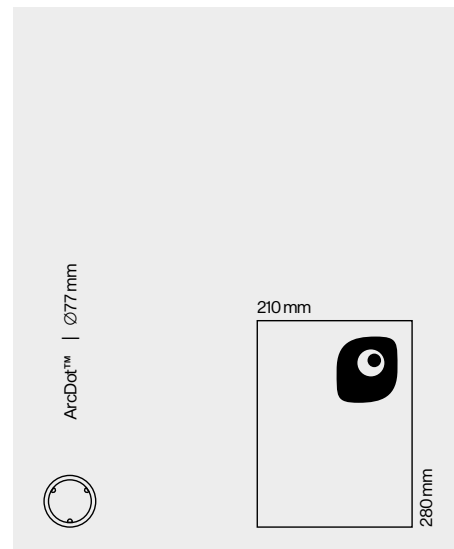

Key Features Flicker-free operation with advanced pixel mapping, remote addressing and status messaging with colour, lash and colour temperature options available.

Lumen Output & Light Source Lumen output of 139 lm is provided by high-power multi-chip LED.

Power Consumption 5.5 W energy consumption provides excellent efficiency with low operating costs.

Physical The durable cast aluminium body with opaque polycarbonate dome provides a compact, stylish and easy-to-mount solution. The fixtures physical dimensions are 77 × 71 mm (3.03 × 2.80 in) and it weighs 0.2 kg (0.44 lbs).

Product Variant



Finish Options

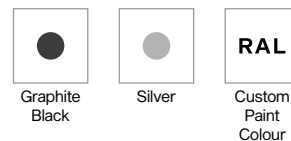

Optic Options



Control & Protocols



Standards and Certifications

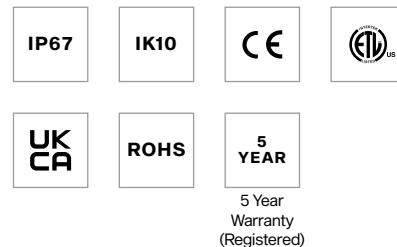

ArcPix™ II

Perfect for complex pixel mapping and media effects on structural surfaces, the ArcPix from Anolis is suitable for both interior and exterior applications. The Plug & Play electronics allow for up to 800 units to be connected to a single ArcPower Unit Pixel. Lighting designers have great flexibility to create dramatic visual effects in a variety of colours. The IP67 rating ensures the fixtures are tough enough to withstand the harshest environmental conditions, giving optimum performance for many years.

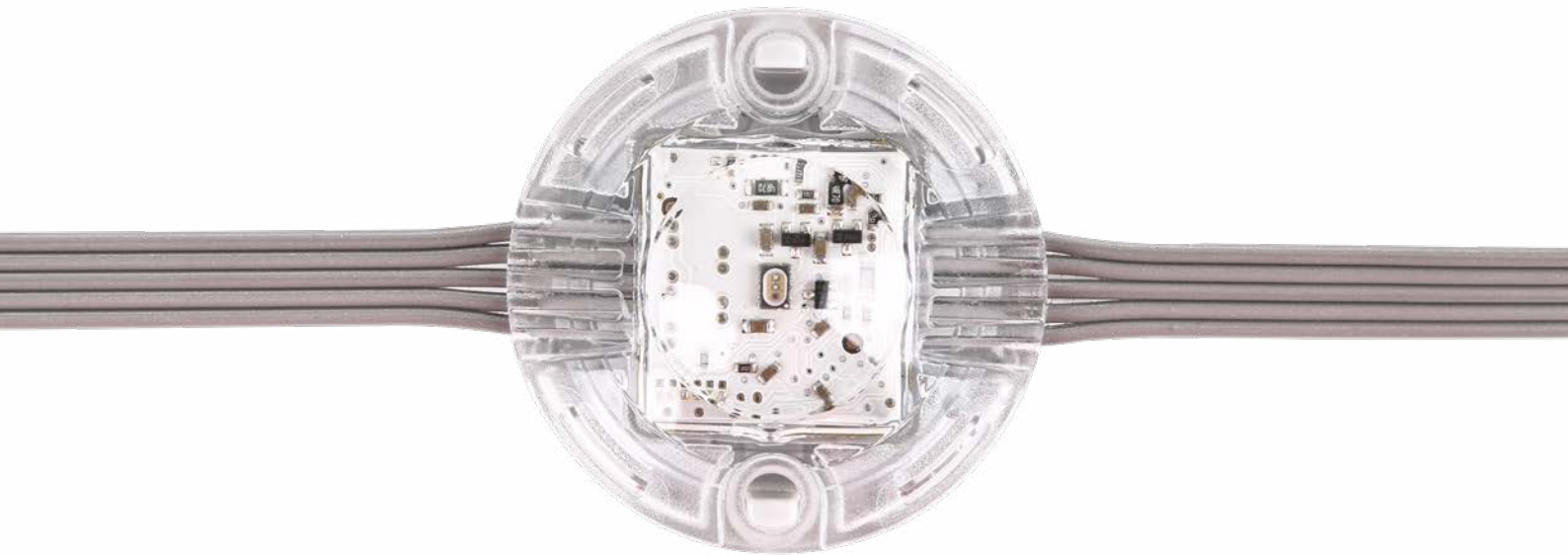

Scale

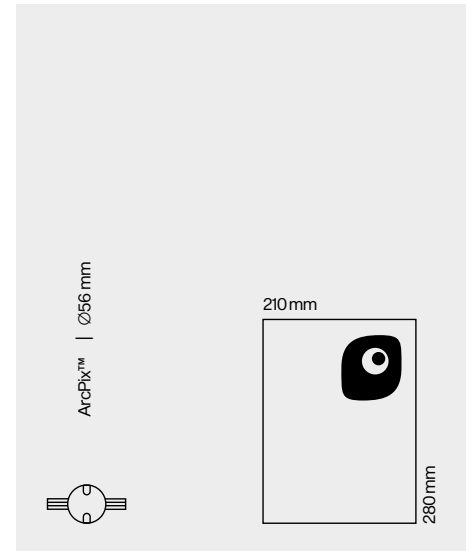

Key Features Small controllable media fixture covered with clear polycarbonate can be connected into strings of 100pcs up to 100 m in length. Up to 400 of ArcPix II can be connected to ArcPixel Power (800pcs when connected to ArcPower Pixel Unit).

Lumen Output & Light Source Lumen output of 86 lm is provided by one multi-chip LED.

Projected Lumen Maintenance The projected lumen maintenance is 90,000 hrs (L90B10).

Power Consumption Low 0.8 W energy consumption provides excellent efficiency at low operating costs.

Physical Moulded plastic body with clear polycarbonate cover provides a compact and durable lighting solution. The fixture's physical dimensions are 56 × 24 mm (2.21 × 0.95 in) and it weighs 0.1 kg (0.22 lbs).

Product Variant



Optic Options



No Optic

Control & Protocols



Standards and Certifications



2 Year
Warranty



5 Year
Warranty
(Registered)



Ambiane™ series



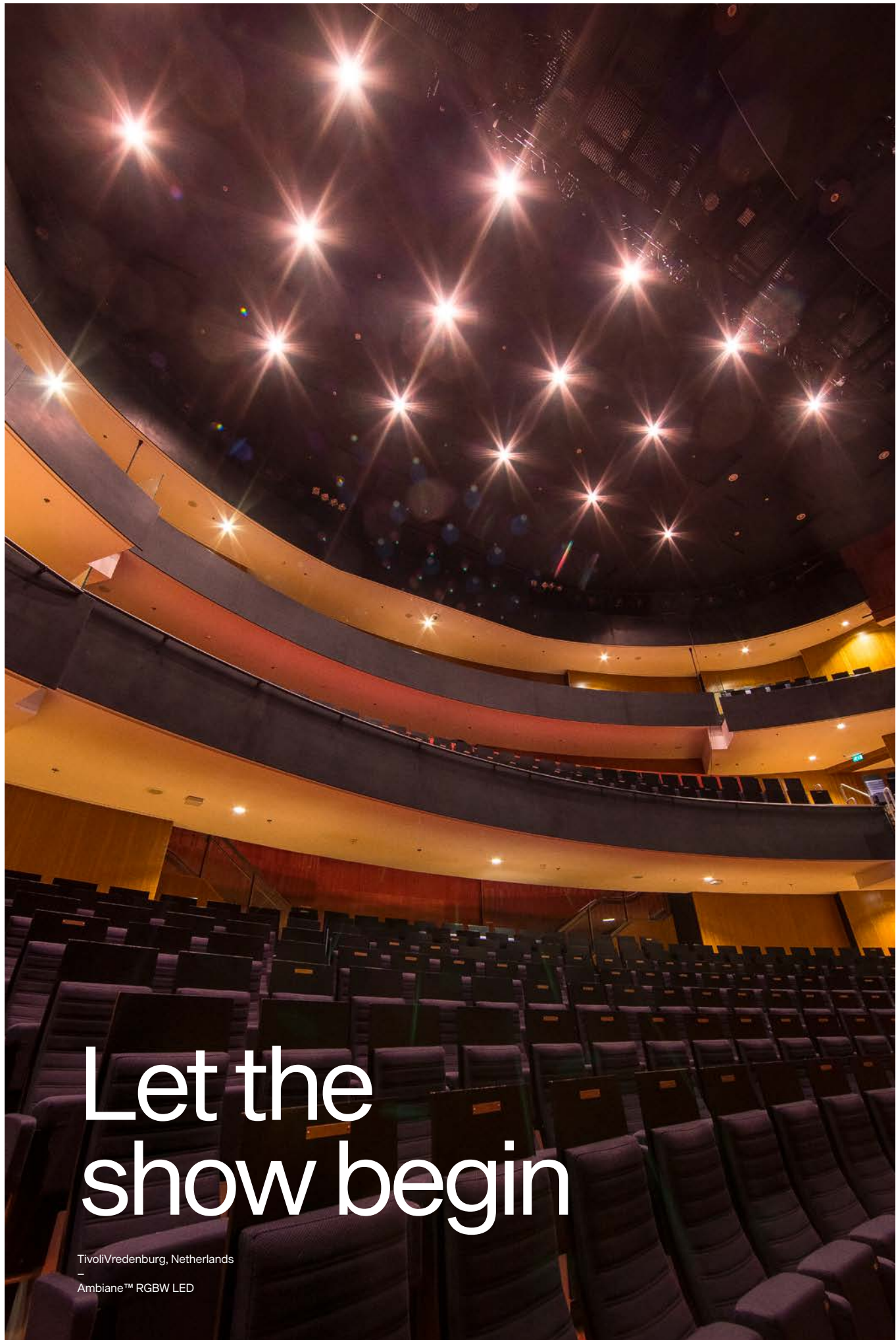

Let the show begin

TivoliVredenburg, Netherlands

Ambiane™ RGBW LED

with right emotions

The Ambiane series is an architectural lighting range that provides the highest quality of illumination. From recessed to surface mount and pendant mounting location, the variability of the range is ideal for auditoriums, houses of worship, entertainment studios, museums, art galleries, conference rooms, and hotel foyers and ballrooms. Offering the highest optical performance, easy control, and mounting flexibility, the Ambiane series was built to cover long, medium, and short throw applications.



TivoliVredenburg, Netherlands
—
Ambiane™ RGBW LED

The TivoliVredenburg in central Utrecht, The Netherlands, features seven different music performance spaces and recently had its house and public area lighting upgraded with Anolis Ambiane RGBW LED luminaires.

The image shows a modern interior space, likely a gallery or museum. The ceiling is a prominent feature, composed of a grid of white, diamond-shaped panels. A central diamond panel is illuminated from within, casting a warm glow. Several black, cylindrical pendant lights are suspended from the ceiling. The walls are illuminated with a vibrant purple light, creating a dramatic atmosphere. The walls are covered with a grid of small, square, perforated panels, which appear to be part of a display or information system. The overall aesthetic is clean, geometric, and contemporary.

Aesthetically

pleasing

Anolis luminaires are developed with an emphasis on performance, flexibility, longevity, control, and last but not least, design ingenuity. Recessed versions of Ambiane seamlessly fit into false-ceiling installations, while pendant versions complement the spacious interior of larger spaces. Its carefully chosen materials, smooth connections edges, and multiple colour finish options, make Ambiane an ideal lighting solution for interior installations.



Ambiane™



Ambiane™ series



Ambiane™ XP56 Recessed

98–99

218



Ambiane™ XP56 Pendant

100–101

220



Ambiane™ XP56 Pendant Remote

102–103

222



Ambiane™ HP111 Recessed

104–105

224



Ambiane™ HP111 Pendant Remote

106–107

226



Ambiane™ HP111 Surface Mount

108–109

228



Ambiane™ AP

110–111

230

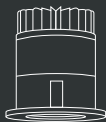

Ambiane™ SP16

112–113

232

Ambiane™ XP56 Recessed

Specifically designed for large theatres, concert halls, auditoriums, houses of worship and hotel foyers that require general ambient light, with the added ability to create mood, the Ambiane XP56 Recessed is the ideal, stylish solution.

This high-performance RGBW luminaire delivers in excess of 10,000 lm and is perfect for setting the mood via its super-smooth colour mixing abilities. Available in 20°, 30°, 45° or 60° beam spreads, Ambiane XP56 Recessed provides perfect coverage of any area. The incorporation of our L3 (Low Light Linearity) dimming system allows seamless fades to black even when mixed with traditional sources. With no UV or IR emissions making it ideal for museums as well, the fixture is easily controlled via DMX or DALI and is RDM compatible. Ambiane XP56 Recessed has been designed for easy installation and is perfect to retrofit into existing PAR 56 size cut-outs.



Scale

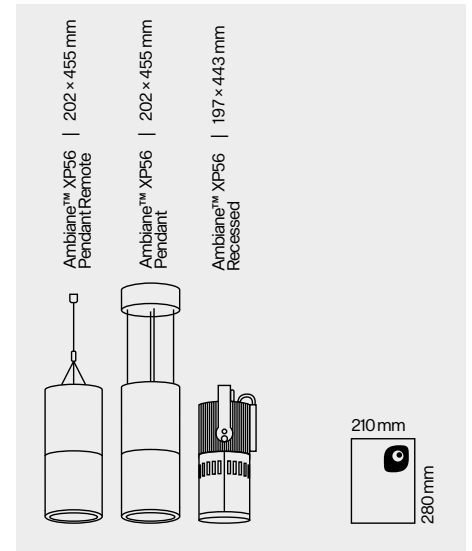

LED Output Available in wide range of colour configurations (RGBW, PW, TW, TD), the Ambiane XP56 Recessed utilises highly-efficient LED modules with CRI 90+ ensuring you can always see every colour as it should be. Through the highest possible luminous flux 10,107 lm, the fixture offers many different beam spreads (20°, 30°, 45° and 60°) for the precise light needed in your lighting installation.

Control Thanks to our unique L3 (Low Light Linearity) 18-bit dimming system, ultra-smooth fade to black and colour mixing are now possible. The fixture's remote setting and device management is realised through DALI and DMX512 control protocols with RDM support.

Installation Replacing an old Par 56 has never been easier as Ambiane XP56 Recessed provides an absolutely silent solution thanks to its fanless construction and robust heat sink. Mounted via false ceiling adaptor or standard yoke, it has Trim or Louver as an optional accessory. The low 48 V DC input voltage secure safe light operation and secondary power for back-up lighting.

Product Variant



Finish Options

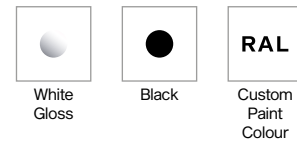

Optic Options



Control & Protocols



Standards and Certifications

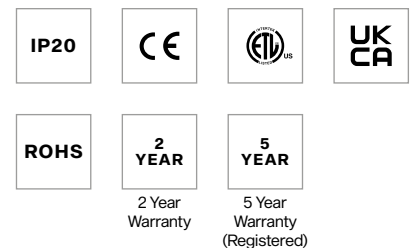

Ambiane™ XP56 Pendant

Following the success of our Ambiane XP56 Recessed luminaire for ceiling installations, Anolis introduces our elegant LED pendant for your architectural lighting design. Ambiane XP56 Pendant accommodates three adjustable wires which allow installers to set an ideal horizontal position of the fixture according to the optical and design requirements. Specifically designed for large theatres, concert halls, auditoriums, houses of worship and hotel foyers that require both general ambient light and the ability to control the visual experience, the Ambiane XP56 Pendant is an ideal, stylish solution. Optically, this high-performance RGBW luminaire delivers in excess of 10,000 lm and is perfect for setting the mood via its extremely smooth colour mixing capabilities. Available in 20, 30, 45 or 60-degree beam spreads, Ambiane XP56 provides beautiful illumination in any area. The incorporation of our L3 (Low Light Linearity) dimming system allows seamless fades to black even when mixed with traditional sources. With no UV or IR emissions which make it optimal for museums as well, the fixture is easily controlled via DMX or DALI and is RDM compatible.



Scale

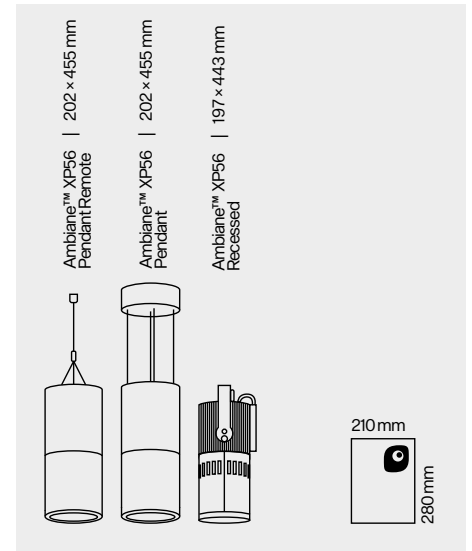

LED Output Available in a wide range of colour configurations (RGBW, PW, TW, TD), the highly efficient LED modules of the Ambiane XP56 Pendant are equally homogenised for a consistent light output. With precision optics and a luminous flux 10,107 lm, the fixture's lifetime 90,000 hrs LED modules guarantee low maintenance cost and long-lasting output. Fixture comes in many different beam spreads (20°, 30°, 45° and 60°), for precisely defined light output, required in a lighting installation.

Control Thanks to our unique L3 (Low Light Linearity) 18-bit dimming system, exceptionally smooth fade to black and colour mixing are now possible. The fixture's remote setting and device management is realised through DALI and DMX512 control protocols with RDM support.

Installation Mounted on ceiling and pending on three wires for easy length and position adjustments. Secondary power input for backup lighting option and absolutely silent solution thanks to its fanless construction and robust heat sink.

Product Variant



Finish Options

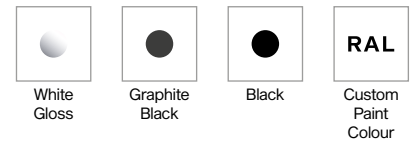

Optic Options



Control & Protocols



Standards and Certifications

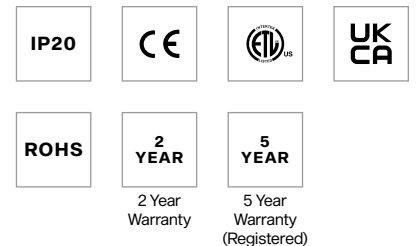

Ambiane™ XP56 Pendant Remote

A significant part of architectural lighting, without any doubts, is retrofitting of installations. In reaction to this fact, Anolis has enriched the Ambiane series and offers a new LED pendant version with remote power supply. Using three adjustable wires which allow installers to set an ideal horizontal position of the fixture according to the optical and design requirements, the Ambiane XP56 Pendant Remote power supply uses the existing electrical circuits. Specifically designed for large theatres, concert halls, auditoriums, houses of worship and hotel foyers that require both general ambient light and the ability to control the visual experience, the Ambiane XP56 Pendant is an ideal, stylish solution. Optically, this high-performance RGBW luminaire delivers in excess of 10,000 lm and is perfect for setting the mood via its extremely smooth colour mixing capabilities. Available in 20, 30, 45 or 60-degree beam spreads, Ambiane XP56 Pendant Remote provides perfect coverage of any area. The incorporation of our L3 (Low Light Linearity) dimming system allows seamless fades to black even when mixed with traditional sources. With no UV or IR emissions which make it optimal for museums as well, the fixture is easily controlled via DMX or DALI and is RDM compatible.



Scale

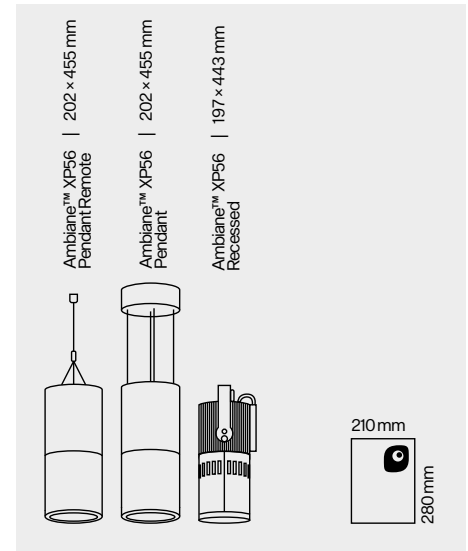

LED Output Available in a wide range of colour configurations (RGBW, PW, TW, TD), the Ambiane XP56 Pendant Remote utilises a high-efficiency LED engine reaching 42 lm/W efficiency. With CRI 90+, you can always see every colour without colouring distortion. The lifetime over 90,000 hrs, provided by its high-quality LED modules, guarantees low maintenance cost and a long-lasting light output. Offering many different beam spreads (20°, 30°, 45° and 60°), you can precisely define light output, required in a lighting installation.

Control Thanks to our unique L3 (Low Light Linearity) 18-bit dimming system, exceptionally smooth fade to black and colour mixing are now possible. The fixture's remote setting and device management is realised through DALI and DMX512 control protocols with RDM support.

Installation Fixture is mounted by one hanging wire and three adjustable wires for desired position and length. Power supply is hidden in false ceiling, which allows the fixture to be easily mounted onto slope ceiling. The low 48V DC input voltage secures a safe light operation with the possibility of a backup power connection to protect against any unexpected blackout.

Product Variant



Finish Options

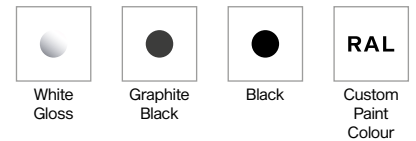

Optic Options



Control & Protocols



Standards and Certifications

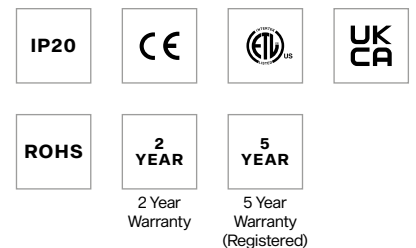

Ambiane™ HP111 Recessed

As the mid-size luminaire in the Ambiane series, the new Ambiane HP111 Recessed is designed for lower ceiling installations or to cover areas where the power of the Ambiane XP56 is not necessary. Using the same light source specification as all other Ambiane series members, the fixture is an ideal add-on to lighting designs using a host of Ambiane luminaires. Giving designers and installers a choice of 20, 40, 60 or 80-degree optical beam spreads, the Ambiane HP111 provides an endless array of positioning options across an entire installation. The incorporation of our L3 (Low Light Linearity) dimming system allows seamless fades to black even when mixed with traditional sources. With no UV or IR emissions which make it ideal for museums as well, the fixture is easily controlled via DMX or DALI and is RDM compatible.



LED Output Available in wide range of colour configurations (RGBW, PW, TW, TD), the Ambiane HP111 Recessed utilises highly efficient LED modules with CRI 90+ ensuring you can always see every colour without colouring distortion. Equally homogenised light output is secured by precisely designed output optics with the highest possible luminous flux 3239 lm and a 90,000 LED lifetime which guarantees low maintenance cost and long-lasting light output. The fixture offers four different beam spreads (20°, 40°, 60° and 80°) for precisely defined light output, required in a lighting installation.

Control Thanks to our unique L3 (Low Light Linearity) 18-bit dimming system, exceptionally smooth fade to black and colour mixing are now possible. The fixture's remote setting and device management is realised through DALI and DMX512 control protocols with RDM support and intelligent power balancing (always 75W output in any mixed colour).

Installation Mounting via holders into false ceiling as an ideal replacement for an outdated AR111 fixture, the Ambiane HP111 offers the possibility of a backup power connection to protect against any unexpected blackout and operate as emergency lighting.

Scale

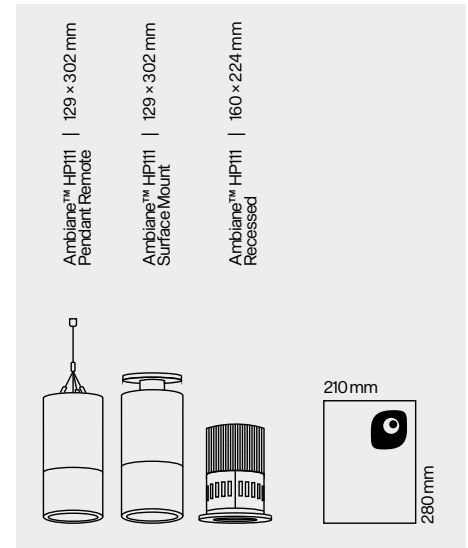

Product Variant



Finish Options

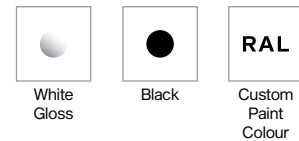

Optic Options



Control & Protocols



Standards and Certifications

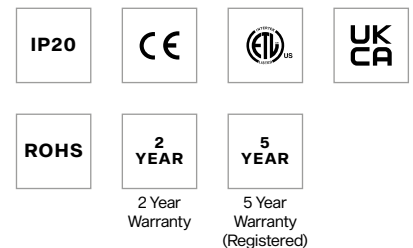

Ambiane™ HP111 Pendant Remote

Each Ambiane luminaire is expertly crafted to fit different types of lighting applications. Ambiane HP111 Pendant Remote is meant to fit mid-throw application and able to be mounted onto sloped ceilings. Using the same light source specification as all other Ambiane series members, the fixture is an ideal add-on to lighting designs using a host of Ambiane luminaires. Giving designers and installers a choice of 20, 40, 60 or 80-degree optical beam spreads, the Ambiane HP111 provides an endless array of positioning options across an entire installation. The incorporation of our L3 (Low Light Linearity) dimming system allows seamless fades to black even when mixed with traditional sources. With no UV or IR emissions which make it ideal for museums as well, the fixture is easily controlled via DMX or DALI and is RDM compatible.



LED Output Available in wide range of colour configurations (RGBW, PW, TW, TD), the Ambiane HP111 Pendant Remote utilises highly efficient LED modules with CRI 90+ ensuring you can always see every colour without colouring distortion. Equally homogenised light output is secured by precisely designed output optics with the highest possible luminous flux 3239 lm and a 90,000 LED lifetime which guarantees low maintenance cost and long-lasting light output. The fixture offers many different beam spreads (20°, 40°, 60° and 80°) for precisely defined light output, required in a lighting installation.

Control Thanks to our unique L3 (Low Light Linearity) 18-bit dimming system, exceptionally smooth fade to black and colour mixing are now possible. The fixture's remote setting and device management is realised through DALI and DMX512 control protocols with RDM support and intelligent power balancing (always 75W output in any mixed colour).

Installation Mounting via ceiling adaptor and adjustable hanging wires allows installation onto sloped ceilings. The Ambiane HP111 Pendant Remote offers the possibility of a backup power connection to protect against any unexpected blackout.

Scale

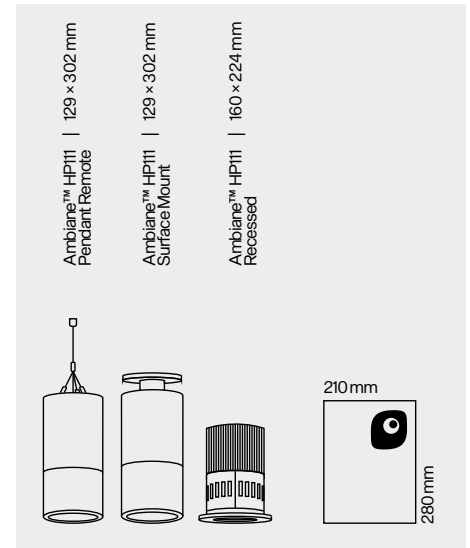

Product Variant



Finish Options

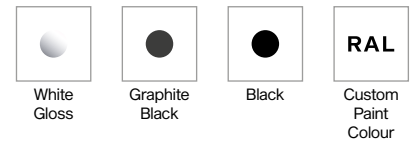

Optic Options

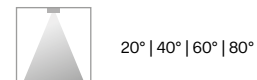

Control & Protocols



Standards and Certifications

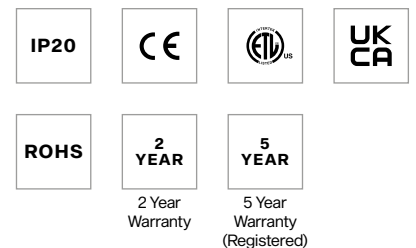

Ambiane™ HP111 Surface Mount

Surface mount version of Ambiane is ideal for mid-throw application onto a levelled ceiling. Same light source specification hidden inside of the beautiful design makes this fixture an ideal add-on to lighting design of Ambiane series. Giving designers and installers a choice of 20, 40, 60 or 80-degree optical beam spreads, the Ambiane HP111 provides an endless array of positioning options across an entire installation. The incorporation of our L3 (Low Light Linearity) dimming system allows seamless fades to black even when mixed with traditional sources. With no UV or IR emissions which make it ideal for museums as well, the fixture is easily controlled via DMX or DALI and is RDM compatible.



LED Output Available in wide range of colour configurations (RGBW, PW, TW, TD), the Ambiane HP111 Surface Mount utilises highly efficient LED modules with CRI 90+ ensuring you can always see every colour as it should be. Equally homogenised light output is secured by precisely designed output optics with the highest possible luminous flux 3239 lm and a 90,000 LED lifetime which guarantees low maintenance cost and long light output. The fixture offers many different beam spreads (20°, 40°, 60° and 80°) for the precise light needed in your lighting installation.

Control Thanks to our unique L3 (Low Light Linearity) 18-bit dimming system, exceptionally smooth fade to black and colour mixing are now possible. The fixture's remote setting and device management is realised through DALI and DMX512 control protocols with RDM support and intelligent power balancing (always 75W output in any mixed colour).

Installation An ideal replacement for an outdated AR111 fixture, the Ambiane HP111 Surface Mount offers the possibility of a backup power connection to protect against any unexpected blackout.

Scale

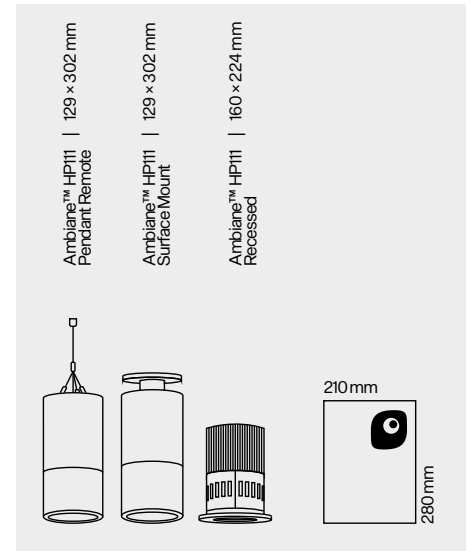

Product Variant



Finish Options

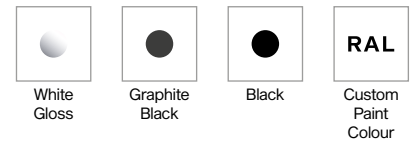

Optic Options



Control & Protocols



Standards and Certifications

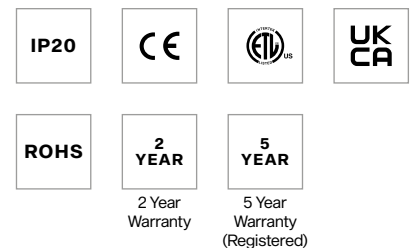

Ambiane™ AP

Compact and powerful downlight from Ambiane range is suitable for ambient lighting applications, wall washing and accent lighting where light quality is of the utmost importance. Its high CRI output, simple control mode with CCT, green correction, and perfectly matching dimming curve with tungsten lamps give lighting designers a unique solution without any compromises. Available in RGBW and tunable white CCT versions, along with two beam angles options, the cool-running Ambiane AP is UV or IR radiation free making it ideal for a wide array of applications including theatres, auditoriums, ballrooms, hotels, offices, restaurants, retail environments and more. With both DMX and DALI control options, combined with a highly efficient LED source and high-quality reflectors for optimum light output, the Ambiane AP can produce truly dramatic results!



- LED Output** Available in wide range of colour configurations (RGBW, PW, TW and TD), the high-efficiency LED modules of the Ambiane AP provides the highest possible luminous flux 2713 lm. With two different beam spreads to choose from (67° and 80°), the equally homogenised light output is secured by precisely designed output optics, and the fixture provides a 90,000 hrs LED lifetime guaranteeing a dependable performance.
- Control** Thanks to our unique L3 (Low Light Linearity) 18-bit dimming system, exceptionally smooth fade to black and colour mixing are now possible. The fixture's remote setting and device management is realised through DALI and DMX512 control protocols with RDM support and intelligent power balancing (always 50W output in any mixed colour).
- Installation** Fixture is mounted via spring clip holders into false ceiling low 48V DC input voltage secures a safe light operation with the possibility of backup power connection to protect against any unexpected blackout.

Scale

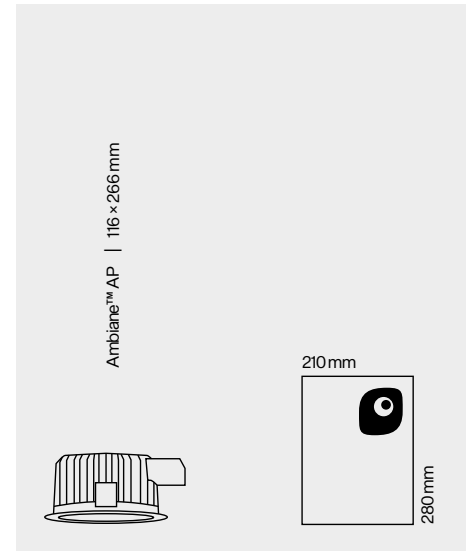

Product Variant



Finish Options

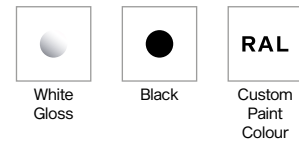

Optic Options

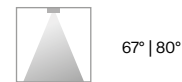

Control & Protocols



Standards and Certifications

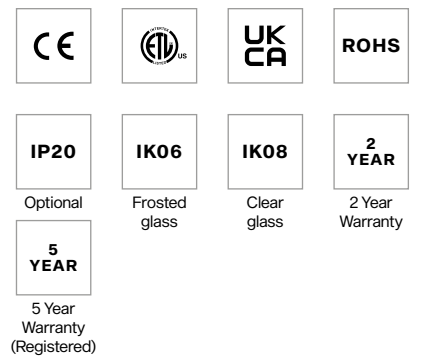

Ambiane™ SP16

The smallest luminaire of Ambiane range with only 108 mm in diameter offers efficient, powerful and high-quality solution for lower ceiling recessed applications. Highly efficient LED module with CRI 90+, no UV or IR emissions, CCT and green correction settings is perfect for museums, art galleries, theaters, concert halls and other most demanding installations. Sharing the same LED chip-set with other Ambiane fixtures it complements the range and gives lighting designers even more options for various interior lighting installations.



LED Output Available in wide range of colour configurations (RGBW, PW, TW, TD), the Ambiane SP utilises highly efficient LED modules with CRI 90+. The fixture offers two different beam spreads of 30° and 60°.

Control Using DALI or USITT DMX512 control protocols, with RDM support, Ambiane SP can be remotely controlled and managed. Ambiane SP also offers intelligent power balancing.

Installation With compact dimensions, Ambiane SP is suitable for lower ceiling applications and to complement our more powerful luminaires of Ambiane range. Ambiane SP is convection cooled for silent operation without fans.

Scale

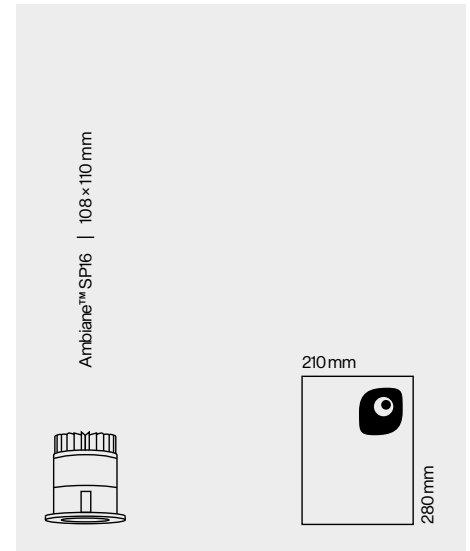

Product Variant



Finish Options

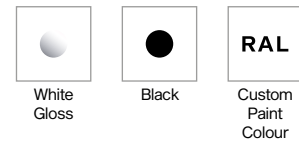

Optic Options

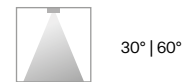

Control & Protocols



Standards and Certifications

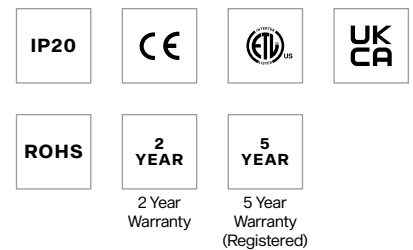



ProMotion™



Total control of your visual creations

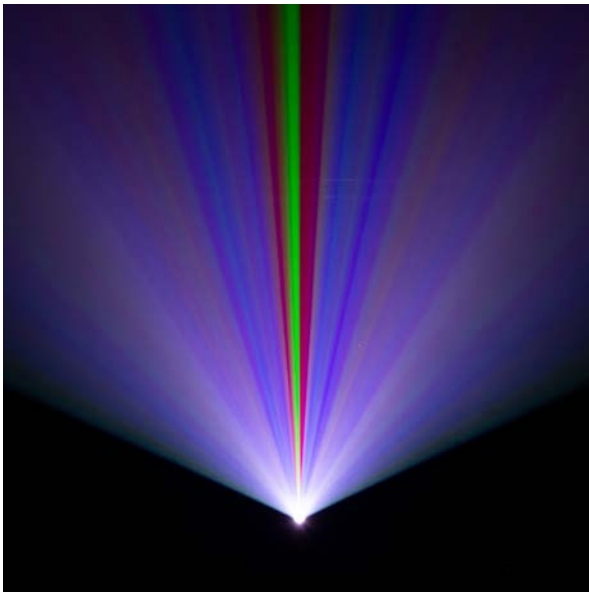

Take retail promotions to the next level with the ProMotion moving head effects and video projector. This Full-HD projector produces 1000 ANSI Lumens of creative output with its long-lasting LED source. Digital gobo patterns with graphic effects plus still and video images. Uploading brand logos, custom artwork, photographs and videos is fast and easy from either a local or off-site multimedia source. With keystone, iris and motorised focus, you have total control of your visual creations. There is also a live streaming input for on-site promotions and integration with other media sales systems.

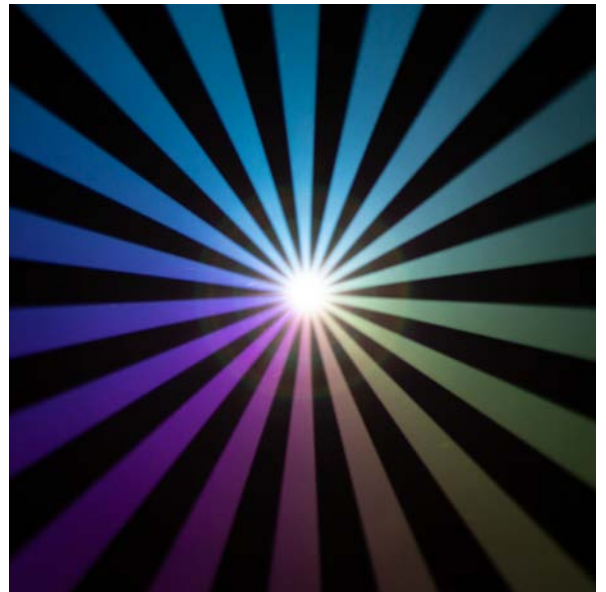
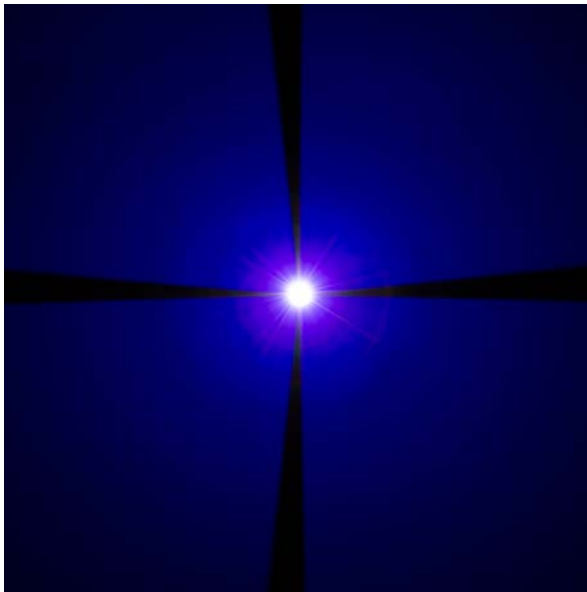



Project
everything
you want

with
ProMotion™



ProMotion™

Product
Type

Product Overview
Page Number

Technical Specification
Page Number



ProMotion™

122–123

234



ProMotion™

Take your bar, club and retail promotions to the next level with the futuristic ROBE ProMotion moving head effects and video projector. Compact, stylish yet fast-moving, this projector produces 1000 ANSI Lumens of creative output with its long-lasting LED source. With RGB and CMY colour mixing capability; digital gobos and graphic effects images and videos; dynamic range of in-built effects, the only limit is your creativity. The ability to upload custom artwork, photographs and videos is enhanced by the live streaming input facility from external high definition multimedia interfaces. With keystone, iris and motorised focus, you have total control of your visual creations. Supplied with two sets of base covers, the first set is suitable for stage applications, while the second set hides control display and cables at the back of the base making it ideal for the retail and installation market. ProMotion can be optionally equipped with an ADM Automatic Distance Meter, to keep the projection absolutely sharp and focused automatically without any user alteration.



Light Source	High power RGB LED engine Full HD resolution
Light Output	Comparable with 5000 ANSI lumen lamp projectors
Zoom Range	17° (throw ratio 3.5) 26° (throw ratio 2.3 wide lens option)
Effects	Digital gobo wheel, Effect wheel, Videos, In-air effects, Live input

Scale

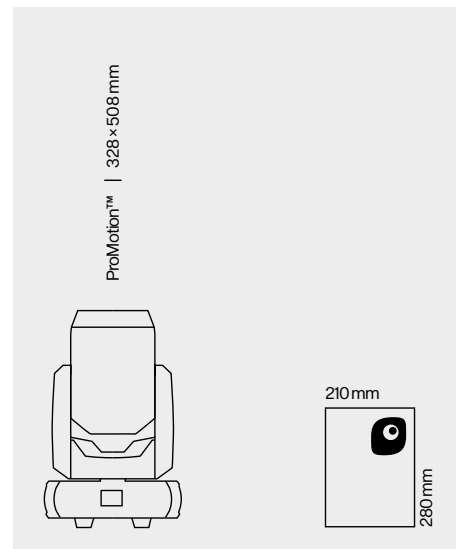

Finish Options



Control & Protocols

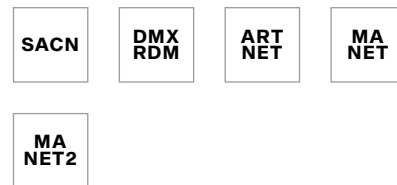

Standards and Certifications

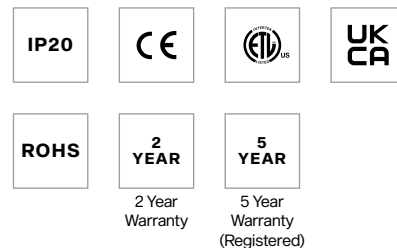



Drivers



One simple output

Offering architectural lighting designers a new way of implementing creativity and innovative technology into the visual experience. Our Eminere series is powered by a comprehensive range of E-Box control systems, which ensure power and data connection, and meets unique installation requirements of each project. With specially designed drivers for remote fixtures, submersible units and pixel control luminaires, Anolis range of drivers provides easy solution for the most of the installations.



Notre-Dame-du-Rosaire, France
–
E-Box™ Lite

The façade of the famous Notre-Dame-du-Rosaire, Catholic shrine and minor basilica within the Sanctuary of Our Lady of Lourdes in southern France has a new Anolis lighting installation with around 80 Anolis products from different ranges. The site is an international pilgrimage destination where the sick can reputedly be miraculously healed by the Lourdes water. Anolis was selected for the breadth of its range of colour changing luminaires – with multiple options needed to precision light the different areas of the façade.

Design and Installation: BLEV
Organisation and ACE EVENT



endless
possibilities



efficient



with
Drivers



Drivers

	Product Type	Product Overview Page Number	Technical Specification Page Number
	E-Box™ Lite	132–133	236
	E-Box™ Daisy	134–135	238
	E-Box™ Star	136–137	240
	E-Box™ Remote	138–139	242
	E-Box™ Remote Basic	140–141	244
	SubDrive™ 1	142–143	246
	SubDrive™ 4	144–145	248
	ArcPower™ Unit Rack/Wall Mount	146–147	250
	ArcPower™ Unit Pixel Rack/Wall Mount	148–149	252
	Ambiance™ Power Rack	150–151	254
	ArcPixel™ Power	152–153	256

E-Box™ Lite

Featuring a single combined power and data output which can connect up to 144 Eminere 1 luminaires, with control via wired DMX or optional wireless DMX for hard to access areas, the E-Box Lite is the ideal combination of technology standards and cost effectiveness.

E-Box Series | Offering architectural lighting designers a new way of implementing creativity and innovative technology into the visual experience, our Eminere series is powered by a comprehensive range of E-Box control systems. Based on the unique installation requirements of each project, the E-Box Lite, E-Box Daisy, and E-Box Star power and data connection devices provide a high level of design flexibility.



Scale

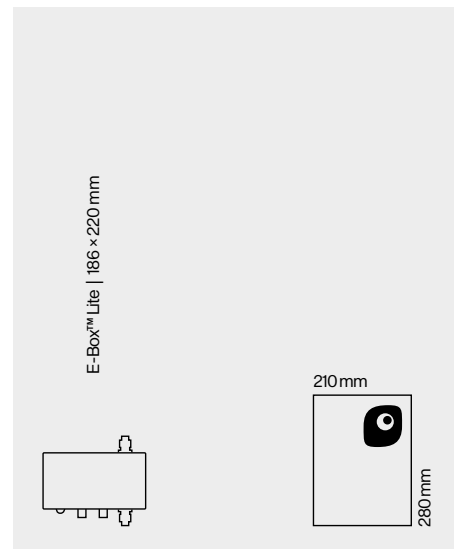

Output One fixture power and data output provides an economical solution for a more simple installation where 159 Eminere luminaires can be connected to the input when the cable length is approximately 30 m (power voltage 230 V).

Control E-Box Lite can be easily configured by its LCD display. In stand-alone mode, you can make three programs on your own containing up to 40 steps. Control is possible through two protocols (DMX512/RDM) and thanks to lumen radio CRMX technology, there is also a wireless DMX option.

Physical E-Box Lite is compact solution providing great durability through its IP67 and IK10 certifications.

Finish Options

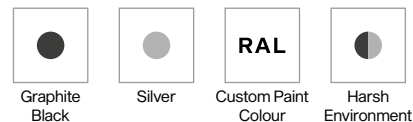

Standards and Certifications

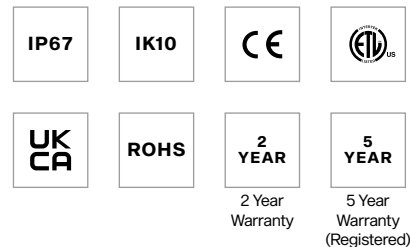

E-Box™ Daisy

Giving designers unlimited creativity options, the E-Box Daisy is a single output device specifically designed for long-run installations, allowing the connection of up to 144 Eminere 1 luminaires in combination with Ethernet control.

E-Box Series | Offering architectural lighting designers a new way of implementing creativity and innovative technology into the visual experience, our Eminere series is powered by a comprehensive range of E-Box control systems. Based on the unique installation requirements of each project, the E-Box Lite, E-Box Daisy, and E-Box Star power and data connection devices provide a high level of design flexibility.



Scale

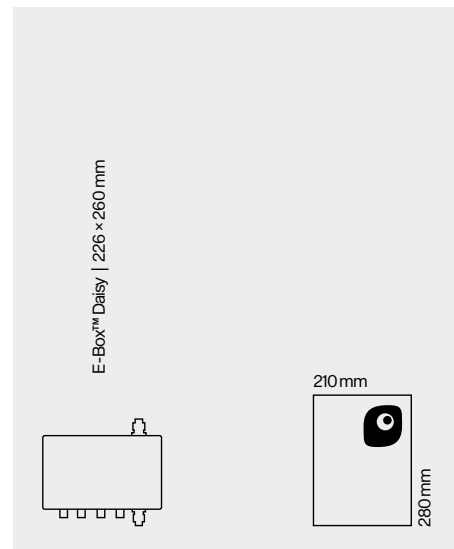

- Output** One fixture power and data output for connecting up to 144 Eminere 1 luminaires.

- Control** E-Box can be easily configured by its LCD display. In stand-alone mode, you can make three programs on your own containing up to 40 steps. Control is possible through a wide variety of protocols (DMX512/ RDM, Art-Net, MA-Net, MA-Net2, sACN, Kling-Net), and thanks to lumen radio CRMX technology, there is also a wireless DMX option.

- Physical** The durable housing provides both IK10 and IP67 protection ratings.

Finish Options

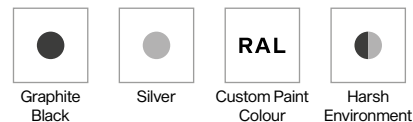

Standards and Certifications

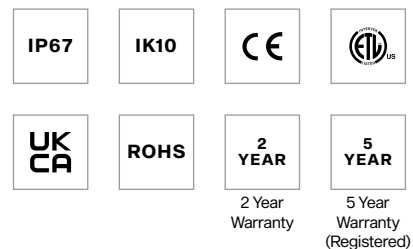

E-Box™ Star

Defining yet another level of wiring and connection flexibility, the E-Box Star provides six independent outputs with centralised controls and a maximum load of up to 144 Eminere 1 luminaires through all outputs.

E-Box Series | Offering architectural lighting designers a new way of implementing creativity and innovative technology into the visual experience, our Eminere series is powered by a comprehensive range of E-Box control systems. Based on the unique installation requirements of each project, the E-Box Lite, E-Box Daisy, and E-Box Star power and data connection devices provide a high level of design flexibility.



- Output** Six independent power and data outputs allow you to connect up to 144 Eminere 1 luminaires.
- Control** E-Box can be easily configured by its LCD display. In stand-alone mode, you can make three programs on your own containing up to 40 steps. Control is possible through a wide variety of protocols (DMX512/ RDM, Art-Net, MA-Net, MA-Net2, sACN, Kling-Net). Thanks to lumen radio CRMX technology, there is also a wireless DMX option.
- Physical** E-Box star is suitable for every installation where more fixture outputs are required, and it provides both IK10 and IP67 certifications through its durable housing.

Scale

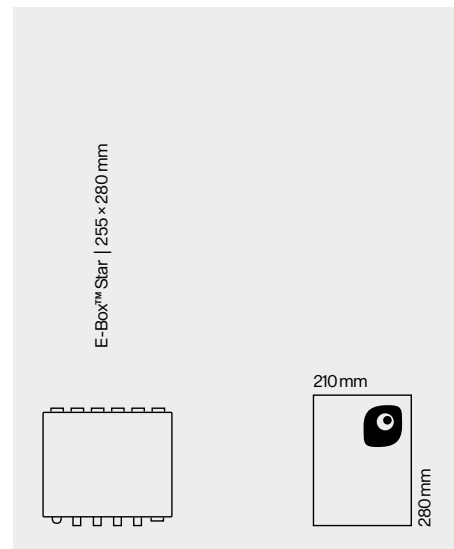

Finish Options

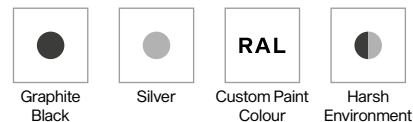

Standards and Certifications

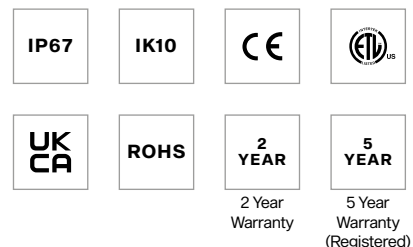

E-Box™ Remote

Specifically designed as an external low voltage power supply for the Eminere Remote series of LED Luminaires, use of the E-Box Remote results in a significantly more compact profile of the Eminere fixture, ideal for applications where high output is needed in a small form factor. A wide range of control protocols is supported including DMX/RDM, optional wireless DMX/RDM via Lumen Radio CRMX technology, Art-Net, sACN, MA-NET, MA-Net2, and Kling-Net. The durable enclosure provides excellent environmental protection with IP65 and IK10 ratings, and a 5 year warranty.



Scale

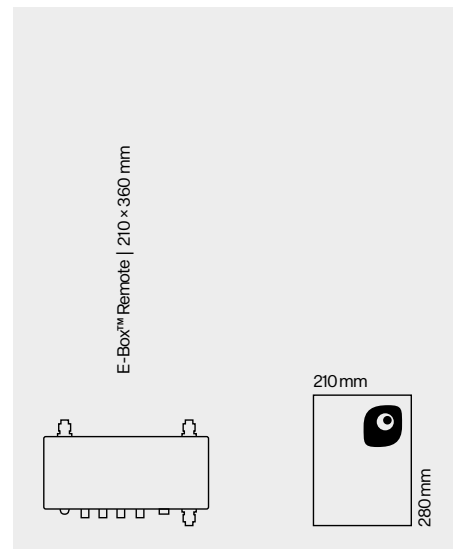

Output The E-Box Remote with double output allows the connection of up to 20 Eminere Remote 1 luminaires per device.

Control E-Box Remote can be easily configured by its LCD display. Control is possible with DMX/RDM, Art-Net, MA-Net, MA-Net2, sACN, and Kling-Net protocols. Wireless DMX/RDM control is available with the Lumen Radio CRMX option.

Physical E-Box Remote holds IP65 and IK10 certifications for robust reliability.

Finish Options

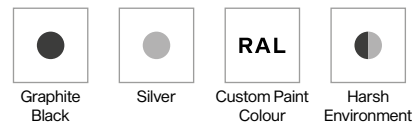

Standards and Certifications

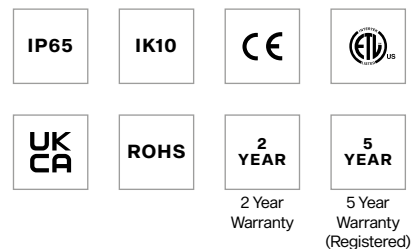

E-Box™ Remote Basic

The most economical solution to control up to 20 Eminere Remote 1 luminaires per device, the E-Box Remote Basic features an auto-ranging power supply suitable for mains voltages between 120–277 V AC for optimal performance. The 48V DC output voltage insures safe operation. With control via wired USITT DMX512, the E-Box Remote Basic is the ideal combination of technology standards and cost effectiveness in a durable housing with both IK10 and IP65 protection ratings and a 5 year warranty.



Output & Control The E-Box Remote with double output allows the connection of up to 20 Eminere Remote 1 luminaires per device with a low 48V output for safe operation.

Physical E-Box Remote holds IP65 and IK10 certifications for robust reliability.

Scale

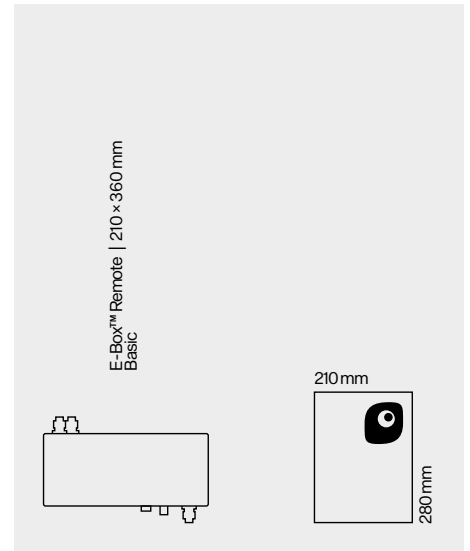

Finish Options

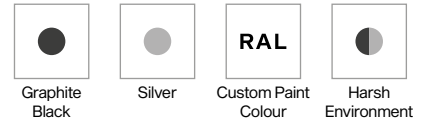

Standards and Certifications

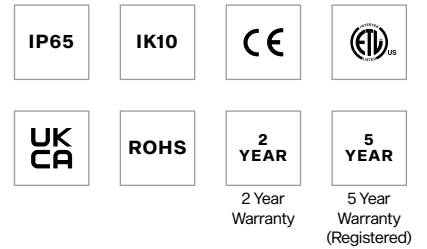

SubDrive™ 1

Specifically designed for ArcSource Submersible II, the SubDrive power supply offers only low voltage and data transfer to fixture. Having options for 1 or 4 outputs, ArcSource Submersible II provides free hands for installation wiring and technical room requirements, while also offering several control modes for single or multiple fixture control, predefined tones of whites, or even \pm green correction.



Input & Output With an input voltage which can be between 100 and 277 V for correct function, the source is providing one low voltage output – 24 V.

Control & Protocol This power supply has a LCD display for easy setting and programming and control is realised through DMX 512 and RDM protocols. The DMX can be also realised in a wireless option and you can preprogram 3 custom programs in stand-alone mode.

Physical Offering a 5 year warranty, the SubDrive 1 is also IP67 and IK10 certified.

Scale

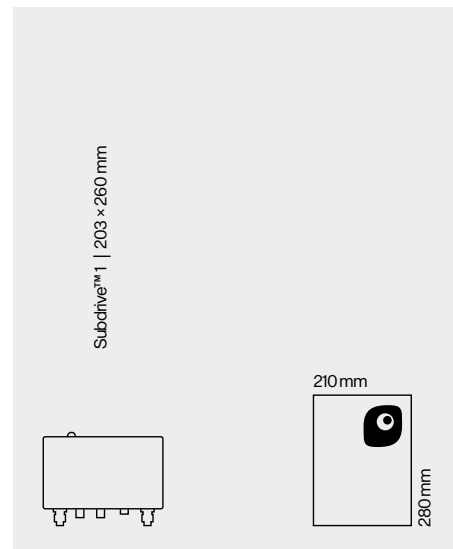

Finish Options

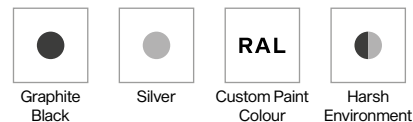

Standards and Certifications

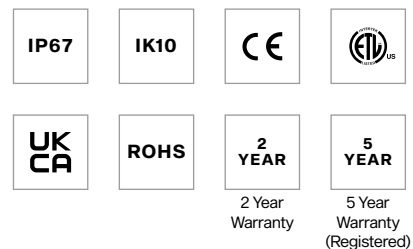

SubDrive™ 4

Specifically designed for ArcSource Submersible II, the SubDrive power supply offers only low voltage and data transfer to fixture. Having options for 1 or 4 outputs, ArcSource Submersible II provides free hands for installation wiring and technical room requirements, while also offering several control modes for single or multiple fixture control, predefined tones of whites, or even \pm green correction.



Scale

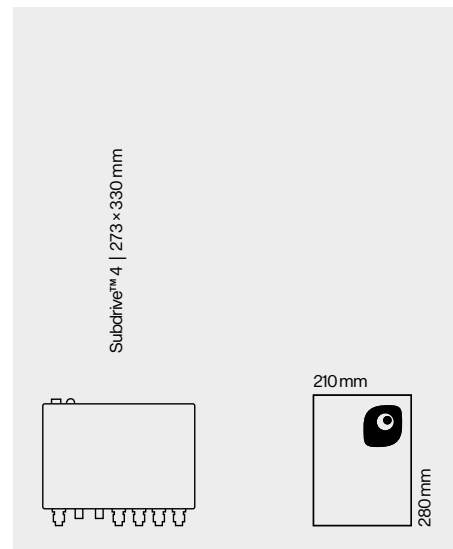

Input & Output With an input voltage which can be between 100 and 277 V for correct function, the source is providing four low voltage outputs – 24 V.

Control & Protocol This power supply has a LCD display for easy setting and programming and control is realised through DMX 512 and RDM protocols. The DMX can be also realised in a wireless option and you can preprogram 3 custom programs in stand-alone mode.

Physical Offering a 5 year warranty, the SubDrive 4 is also IP66 and IK10 certified.

Finish Options

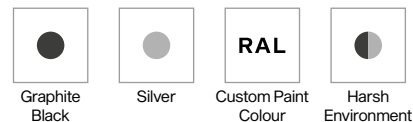

Standards and Certifications

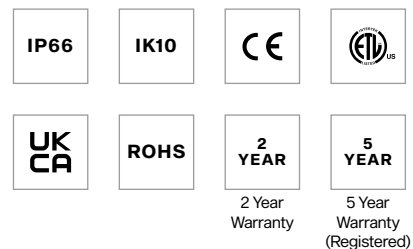

ArcPower™ Unit

The ArcPower Unit is available in Rack or Wall mount options for maximum installation flexibility. Integrating the latest technology to offer even greater performance in terms of both efficiency and flexibility, and capable of producing both 48 V and 24 V as outputs, allowing global use without power compatibility issues. 8 individual outputs on the 48V version (6 on the 24V version) allow cabling of fixtures efficiently and economically.



Scale

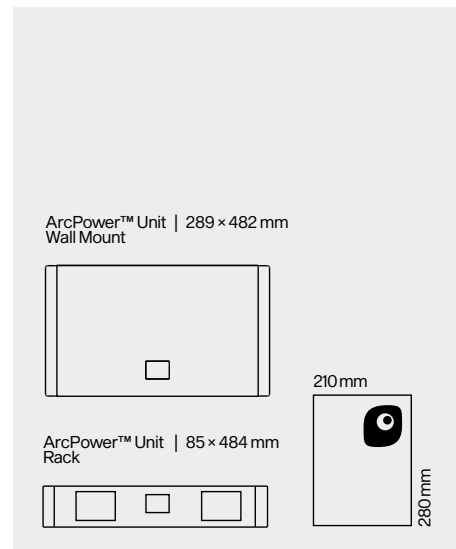

LED Output	There is connection for 8 pixel zones via RJ45 or terminal blocks in 48V version and 6 pixel zones in 24V version.
Control Protocol (Connector)	ArcPower Unit Rack can be controlled by wide variety of protocols (DMX512, ArtNet, MANet, MANet2, sACN).
Input Voltage	Input voltage can be between 100 and 240 V AC 50/60 Hz. Output power supply cable has 1m (3.28 ft.) length.
Physical (Max W x H x D)	Box dimensions are 484 x 90 x 321 mm – 6.5 kg (19.05 x 3.54 x 12.64 in. – 14.3 lbs) Power unit can be mounted on rack or on wall.

Finish Options

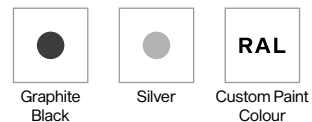

Control & Protocols



Standards and Certifications

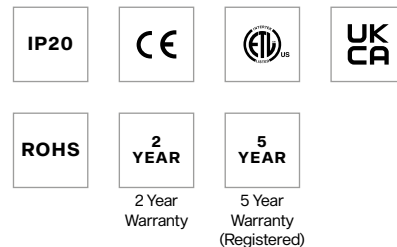

ArcPower™ Unit Pixel

The ArcPower Unit Pixel is available in Rack or Wall mount options for maximum installation flexibility. Integrating the latest technology to offer even greater performance in terms of both efficiency and flexibility, and capable of producing both 48 V and 24 V as outputs, allowing global use without power compatibility issues. 8 individual outputs on the 48V version (6 on the 28V version) allow cabling of fixtures efficiently and economically, especially when using pixel based luminaires.



Control Protocol (Connector)	ArcPower Unit Pixel can be controlled by wide variety of protocols (DMX512, ArtNet, MANet, MANet2, sACN).
Input Voltage	Input voltage can be between 100 and 240 V AC 50/60 Hz. Output power supply cable has 1 m (3.28 ft.) length.
Physical (Max W × H × D)	Box dimensions are 484 × 90 × 321 mm – 6.5 kg (19.05 × 3.54 × 12.64 in. – 14.3 lbs) Power unit can be mounted on rack or on wall.

Scale

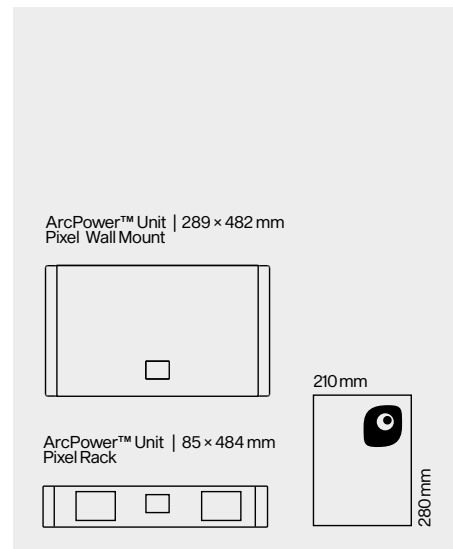

Finish Options

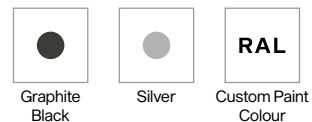

Control & Protocols



Standards and Certifications

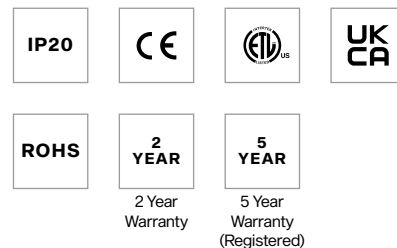

Ambiane™ Power Rack

The Ambiane Power Rack provides remote powering of our Ambiane LED luminaires in an elegant and orderly installation using well-organised rack cases. Integrating 8 power supplies which can feed 8 Ambiane luminaires with full temperature control, the Ambiane Power Rack is suitable for less ventilated areas or locations, and its easy output connections via terminal blocks makes installation easy to complete.



Physical Ambiane Power Rack is available in Rack-mount or Wall-mount version, it has a long service life thanks to its fan-cooling system with replaceable air filters.

Connectivity Its able to power 8 luminaires with up to 75 m of cable length and 200 W for each output.

Scale

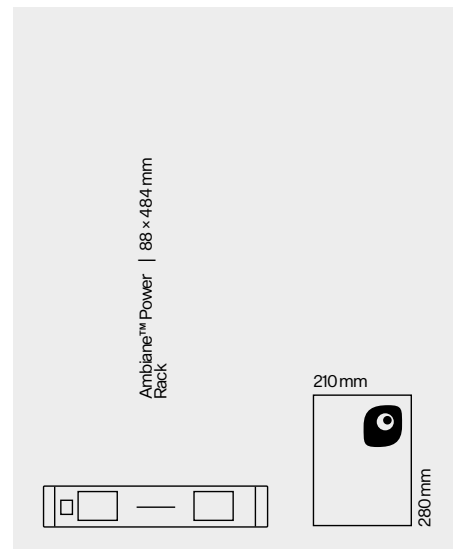

Finish Options

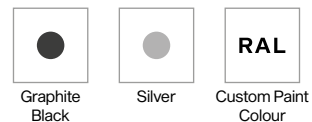

Standards and Certifications

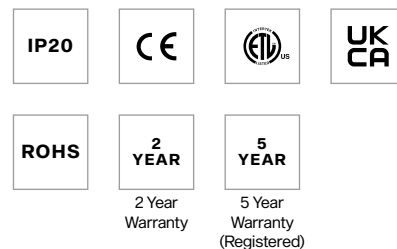

ArcPixel™ Power

Powering ArcSource Outdoor 4MC Pixel, the ArcPixel Power allows a large quantity of products to be connected simultaneously whilst Auto Addressing makes installation and set up easy. Compatible with both DMX and Art-Net protocols, the integration with media servers allows complex media programming, and dynamic pixel control. The unit includes an integrated web interface giving a quick overview of many settings via a connected PC. When pixel control is required, ArcPixel Power provides the most effective and simple solution.

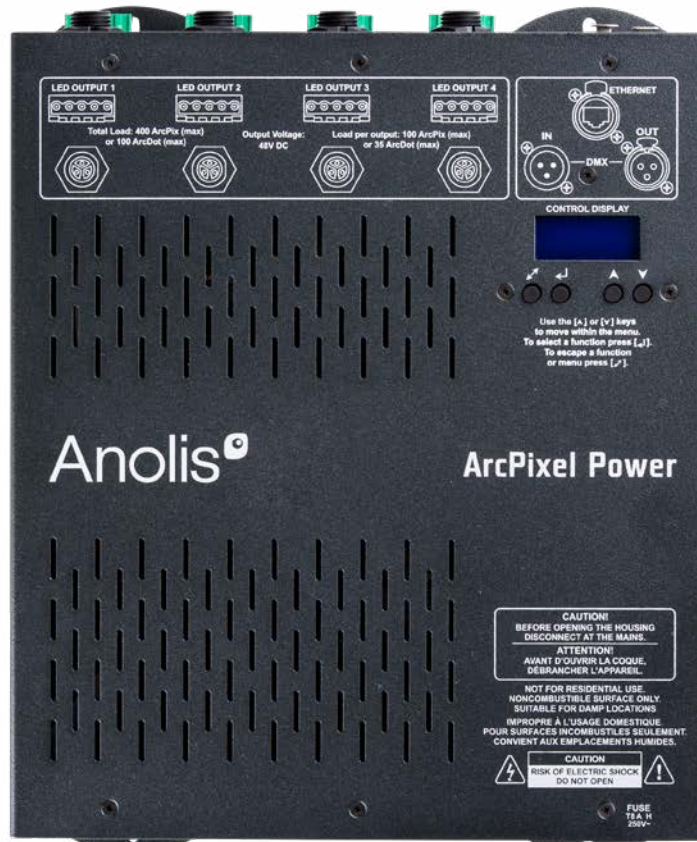

Key Features	Flicker-free smooth dimming and control. Stand-Alone and Auto-Start operation options. Ideal for ArcSource, White and Colour-changing products.
LED Output	4 Zone via ArtNet, 3 Zone via DMX, CE version – ArcSource Outdoor 4MC Pixel: 35 (typically 25), US version – ArcSource Outdoor 4MC Pixel: 16.
Control Protocol (Connector)	USITT DMX512, RDM, ArtNet.
Input Voltage	100–240 V AC 50/60 Hz Typ. 650 W 1 m captive cable.

Scale

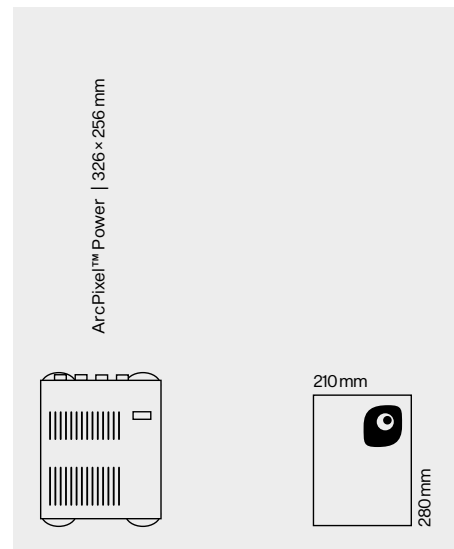

Finish Options

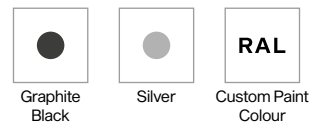

Control & Protocols



Standards and Certifications

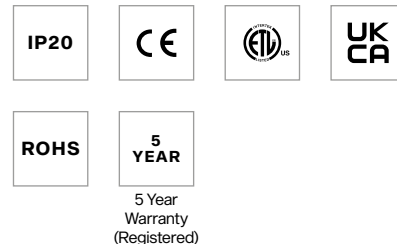



Control



Nottingham Castle

—
Divine™ 160



Small devices



Nottingham Castle
—
Divine™ 160

to rule them all

Have a complete control over the addressing, sorting, setting, light output, scenes, zones, monitoring and software updates of Anolis fixtures.

A photograph of a modern architectural interior. The ceiling is a curved, textured concrete structure. The space is illuminated with vibrant, multi-colored lights (red, blue, green, yellow) that create a dynamic atmosphere. In the foreground, there are several white, modular seating units. The text "You are in" is overlaid in a large, white, sans-serif font across the center of the image.

You are in



n control

with
Anolis



Control series

Product
Type

Product Overview
Page Number

Technical Specification
Page Number



ArcControl™ DU

162–163

258

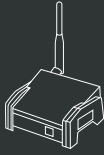

RUNIT WTX™

164–165

260

ArcControl™ DU

ArcControl DU brings the dimmer switch into the 21st century. The simple glass touch interface is backed by world leading lighting control software which allows creative programming for all types of applications. Multi-room control with 500 scenes and 10 zones allow the user to precisely control dramatic scenes. Programmable via PC/Mac and connected directly via micro USB/Ethernet, the ArcControl DU allows the user complete flexibility. The sleek glass touch interface is both aesthetically pleasing as well as intuitive and easy to use. Via DMX, ArcControl DU is ready to connect to all Anolis systems, keeping the user in complete control. Applications include Architectural, Retail, Domestic, Leisure and Entertainment.

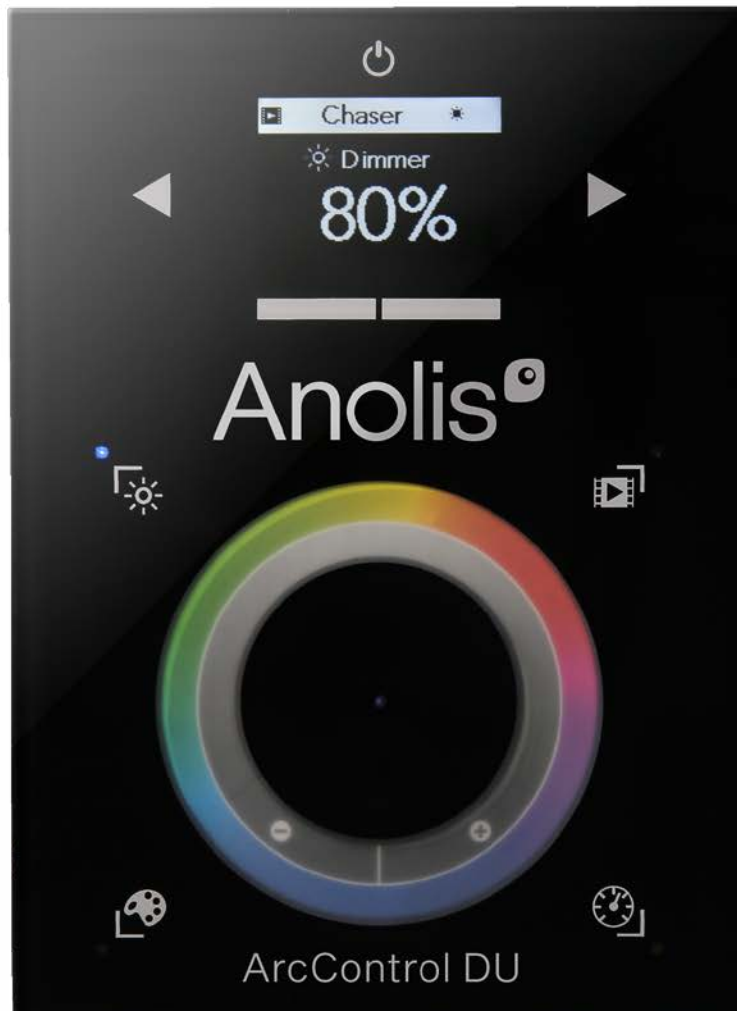

Scale

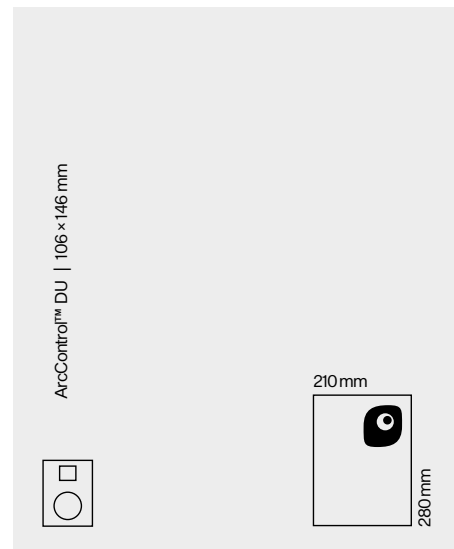

Control Easy to program and control from PC/Mac, Tablet or Smartphone via Wifi network with one of 3 different apps and 2 × DMX512.

Connection Power+DMX connection via RJ45 or connector block, Ethernet connection, mini USB to connect with computer and microSD to store scenes.

Physical Mount with single or double-gang wall socket. Input power 6–7 V DC 0.6 A and rechargeable battery to store the clock/calendar.

Finish Options



Standards and Certifications

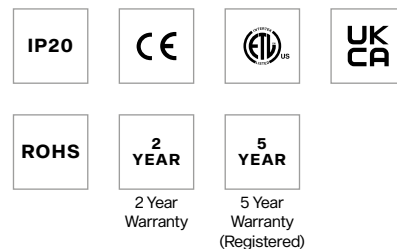

RUNIT WTX™

Wireless DMX + RDM enhanced version of the ROBE Universal Interface magnifies this powerful multi-functional toolbox. The unit communicates with a PC or Laptop via USB and besides the standard ROBE Universal Interface features it provides wireless capabilities for both DMX controlling and bi-directional RDM setup, management and monitoring. Fixture software updates can now be carried out via wired link. The wireless communication is based on robust CRMX technology which includes advanced features such as automated cognitive coexistence, DMX fidelity, low latency, strong encryption and more.



Scale

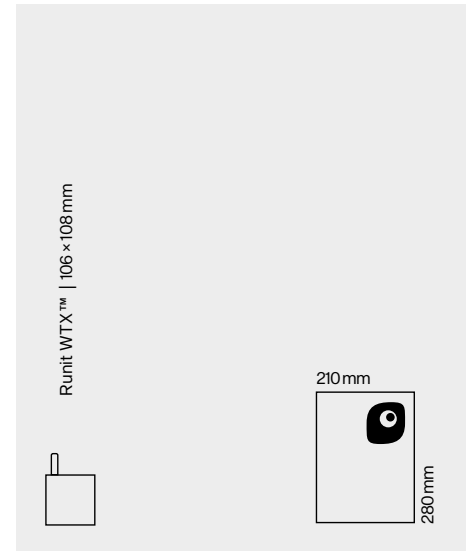

Standards and Certifications



2 Year
Warranty

Control Powered from USB and supporting all versions of Windows from “10” to “Server 2003” and MacOS X v10.5 and above, RUNIT brings RDM communication protocol into DMX 512 control systems. It provides fixture SW update, status monitoring, personality setting and auto-patch. RUNIT WTX is equipped with robust CRMX technology enabling reliable wireless control.

Physical Device is built of rugged aluminium housing with 5-pin XLR connector, USB, build-in display and unpluggable WTX version with CRMX antenna.



Technical Specification

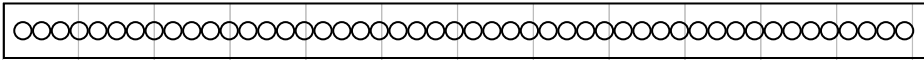

Eminere™ 4 | 76 × 1229 mm

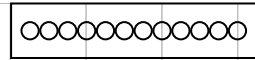

Eminere™ 1 | 76 × 329 mm

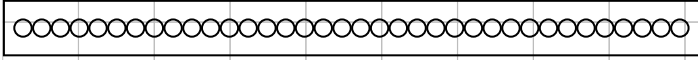

Eminere™ 3 | 76 × 929 mm

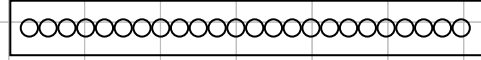

Eminere™ 2 | 76 × 629 mm

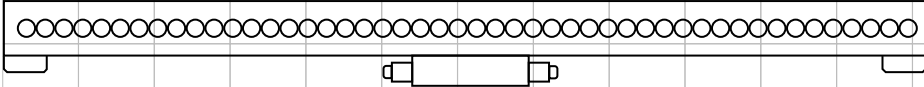

Eminere™ Remote 4 | 113 × 1229 mm

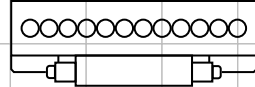

Eminere™ Remote 1 | 113 × 329 mm

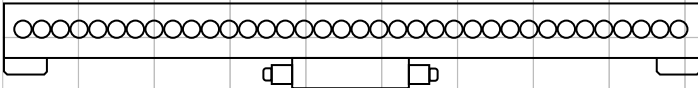

Eminere™ Remote 3 | 113 × 929 mm



Eminere™ Remote 2 | 113 × 629 mm

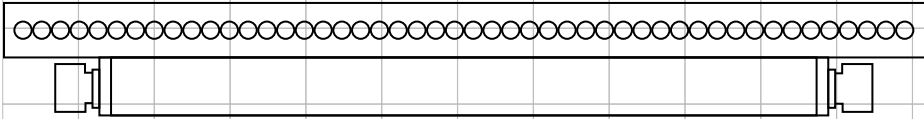

Eminere™ Side 4 | 148 × 1229 mm

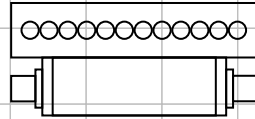

Eminere™ Side 1 | 148 × 329 mm

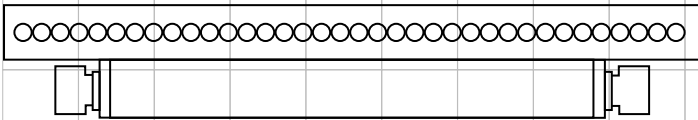

Eminere™ Side 3 | 148 × 929 mm

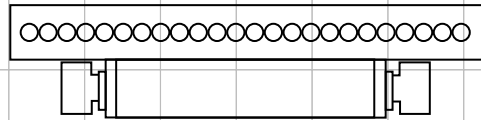

Eminere™ Side 2 | 148 × 629 mm

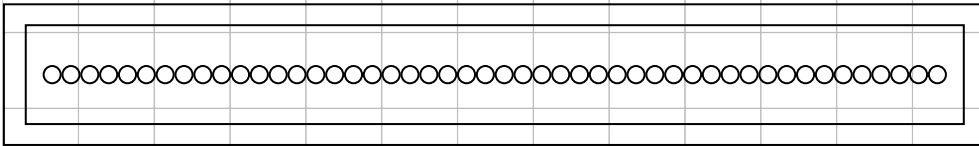

Eminere™ Inground 4 | 186 × 1307 mm

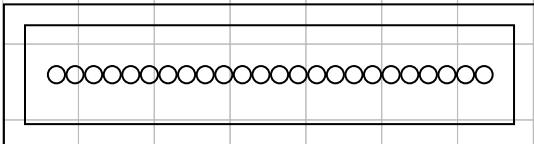

Eminere™ Inground 2 | 186 × 707 mm

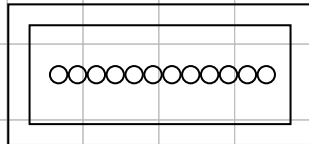

Eminere™ Inground 1 | 186 × 407 mm

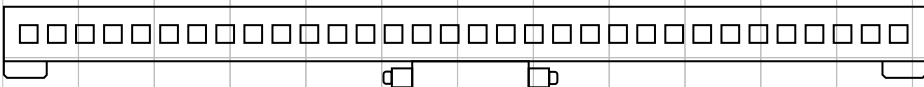

Eminere™ Remote UV 4 | 113 × 1229 mm

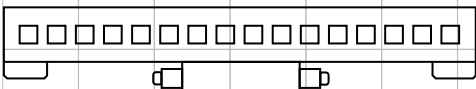

Eminere™ Remote UV 2 | 113 × 629 mm

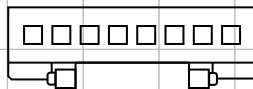

Eminere™ Remote UV 1 | 113 × 329 mm

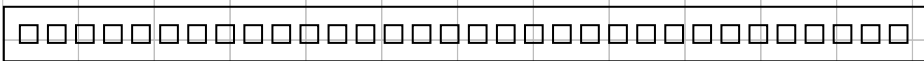

Eminere™ UV 4 | 76 × 1229 mm

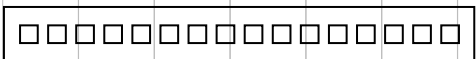

Eminere™ UV 2 | 76 × 629 mm

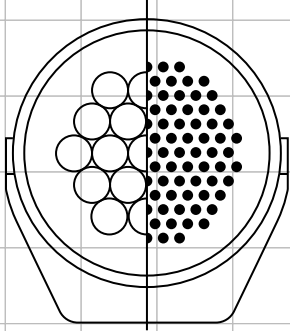

Calumma™ XL MC | 385 × 404 mm
Calumma™ XL SC | 385 × 404 mm

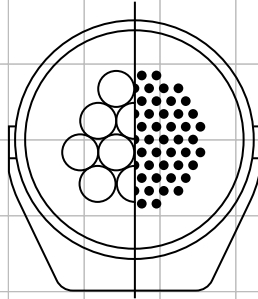

Calumma™ L MC | 338 × 359 mm
Calumma™ L SC | 338 × 359 mm

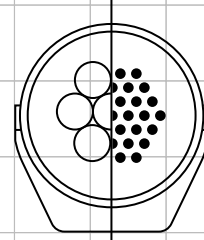

Calumma™ M MC | 264 × 278 mm
Calumma™ M SC | 264 × 278 mm

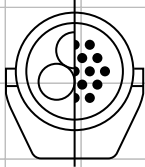

Calumma™ S MC | 189 × 196 mm
Calumma™ S SC | 189 × 196 mm



Calumma™ XS MC | 94 × 108 mm

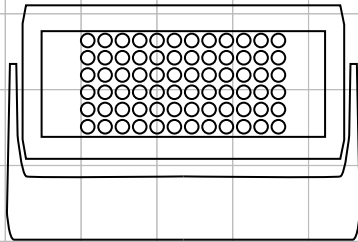

Divine™ 72 | 314 × 463 mm

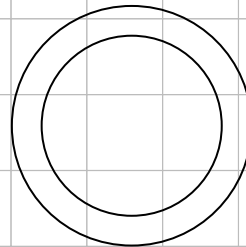

ASI™ 24 MC Inground | Ø320 mm

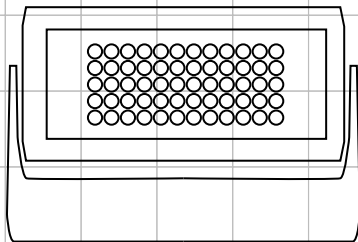

Divine™ 60 UV | 314 × 463 mm

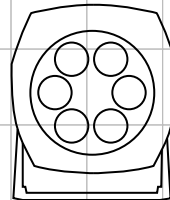

ArcSource™ Submersible II | 216 × 261 mm

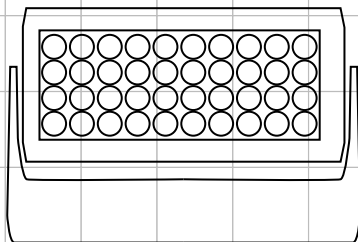

Divine™ 160 | 314 × 463 mm

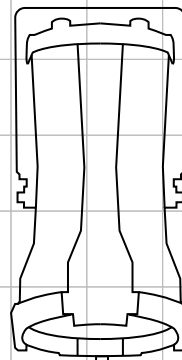

ArcPar™ 150 | 234 × 489 mm
Outdoor



ArcDot™ | Ø77 mm



ArcPix™ II | Ø56 mm

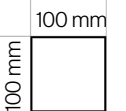

100 mm

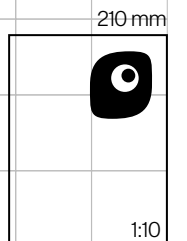

210 mm

280 mm

1:10

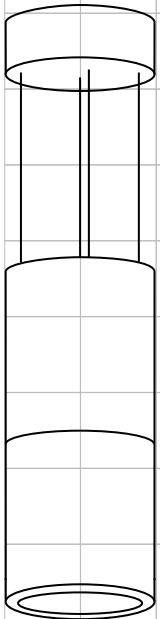

Ambiane™ XP56 | 202 × 455 mm
Pendant

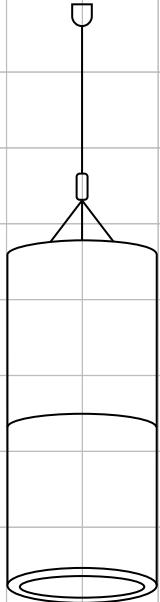

Ambiane™ XP56 | 202 × 455 mm
Pendant Remote

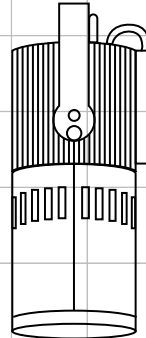

Ambiane™ XP56 | 197 × 443 mm
Recessed

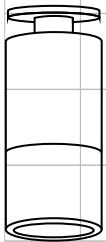

Ambiane™ HP111 | 129 × 302mm
Surface Mount



Ambiane™ HP111 | 129 × 302 mm
Pendant Remote

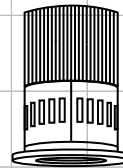

Ambiane™ HP111 | 160 × 224 mm
Recessed

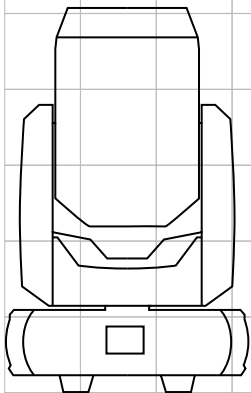

ProMotion™ | 328 × 508 mm



Ambiane™ SP16 | 108 × 110 mm

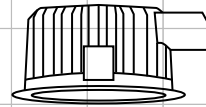

Ambiane™ AP | 116 × 266 mm

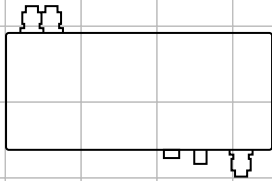

E-Box™ Remote Basic | 210 × 360 mm

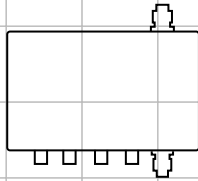

E-Box™ Daisy | 226 × 260 mm

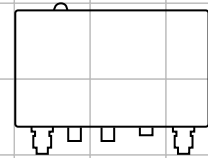

SubDrive™ 1 | 203 × 260 mm

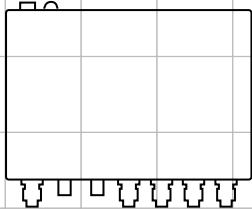

SubDrive™ 4 | 273 × 330 mm

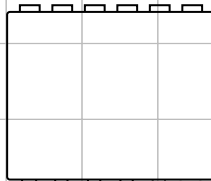

E-Box™ Star | 255 × 280 mm

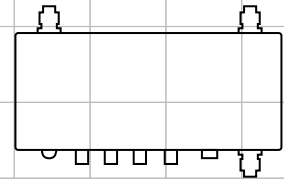

E-Box™ Remote | 210 × 360 mm

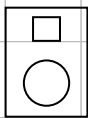

ArcControl™ DU | 106 × 146 mm

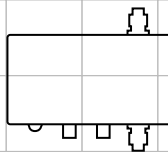

E-Box™ Lite | 186 × 220 mm

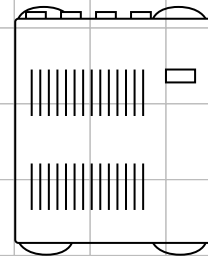

ArcPixel™ Power | 326 × 256 mm

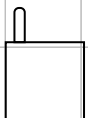

Runit WTX™ | 106 × 108 mm

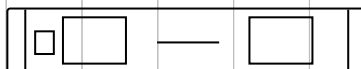

Ambiane™ Power Rack | 88 × 484 mm

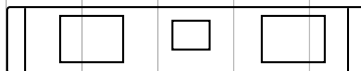

ArcPower™ Unit Rack Mount | 88 × 484 mm

ArcPower™ Unit Pixel Rack Mount | 88 × 484 mm

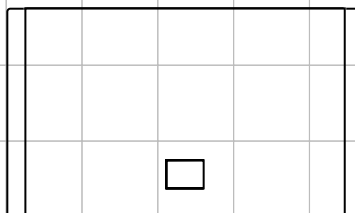

ArcPower™ Unit Wall Mount | 289 × 482 mm

ArcPower™ Unit Pixel Wall Mount | 289 × 482 mm

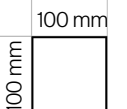

100 mm

280 mm

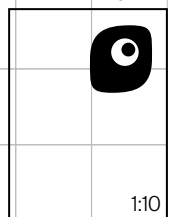

210 mm

1:10

Eminere™

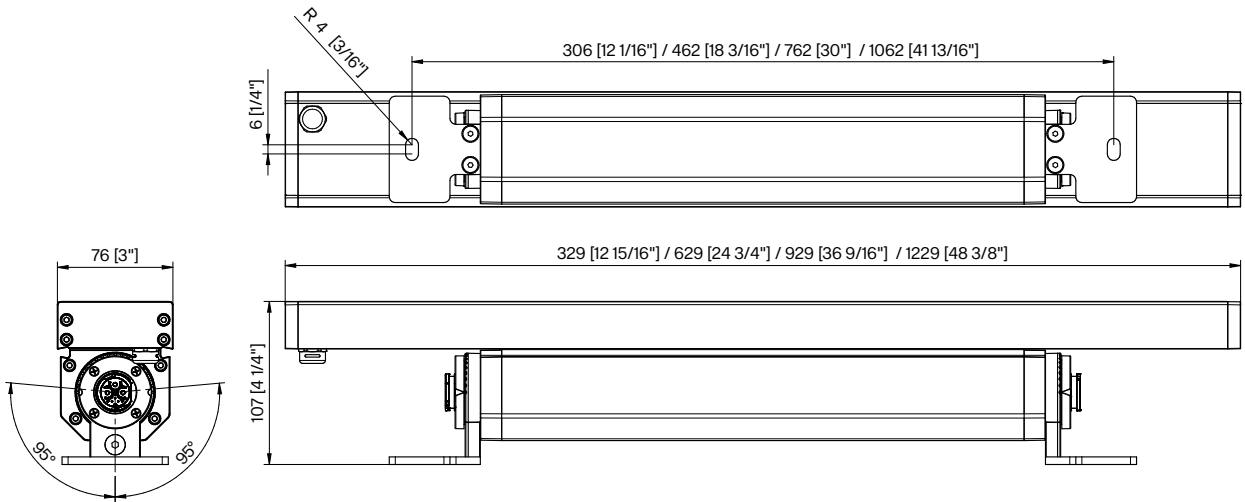

Luminous emittance 1 / Polar LDC

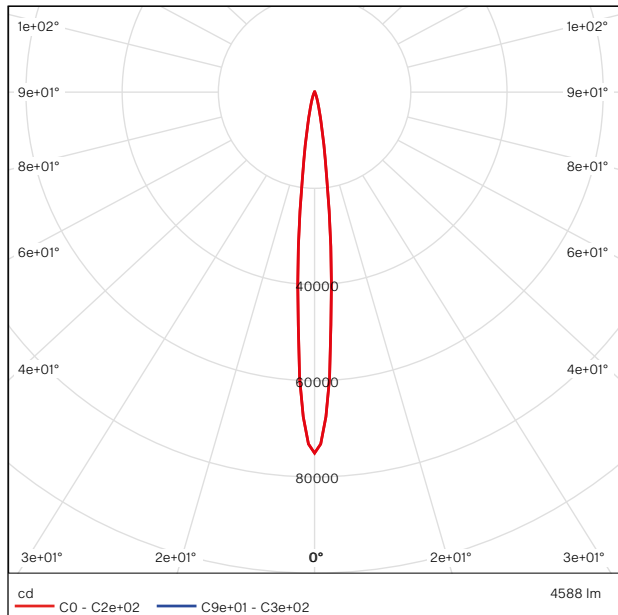

Luminous emittance 1 / Cone diagram

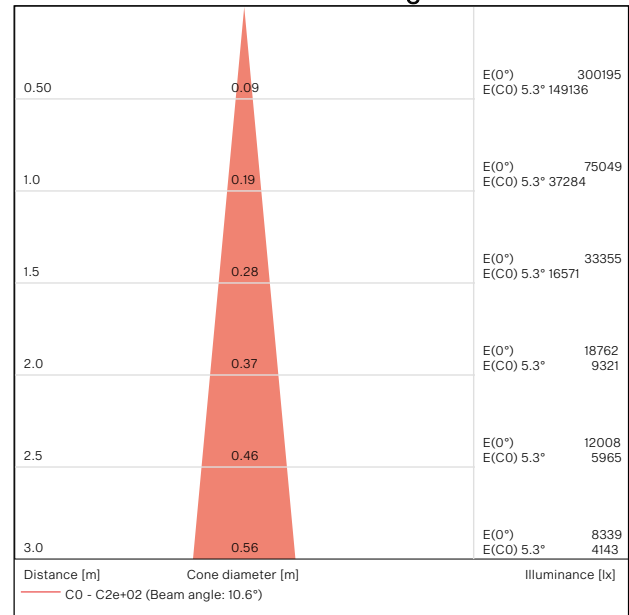

Electrical	Input Voltage	120–277 V AC 50/60 Hz			
	Typical Power Consumption	Eminere 1	25 W		
		Eminere 2	45 W		
		Eminere 3	65 W		
		Eminere 4	85 W		
Optical	Colour Variants	RGBW (W – 6500 K) RGBA PW (W – 3000 K)			
		Variants On Request: TW (2700–6500 K) 2200 K 2500 K 2700 K 3500 K 4000 K 5000 K 6500 K			
	Beam Angle	Symmetrical: 9° 15° 30° 50° 65° 100°			
		Bi-Symmetrical: 10° × 30° 30° × 10° 10° × 60° 60° × 10° 35° × 70° 70° × 35° 15° × 90° 90° × 15°			
		Asymmetrical: Wallwasher Wide Wallwasher			
Lumen Output Delivered	Eminere 1	1147 lm, RGBW @ 9°			
	Eminere 2	2294 lm, RGBW @ 9°			
	Eminere 3	3441 lm, RGBW @ 9°			
	Eminere 4	4588 lm, RGBW @ 9°			
Projected Lumen Maintenance	L90B10 >90.000 hrs, Ta = 25°C / 77°F				
Control	Interface Protocol	Via E-Box Range Or Wireless DMX (Excluded Eminere 1)			
	E-Box Control Protocols	USITT DMX512, RDM, ArtNet, MA Net, MA Net2, sACN, Kling-Net			
	Wireless DMX (Option)	Lumen Radio CRMX Technology			
	Operating Modes	Pixel (12 LED) Or Fixture Mode			
	Setting / Addressing	Via Two Row LCD Display With Control Buttons Or RDM Communicator			
	Power Supply	Integrated			
	Connectivity	E-Box Lite	144 Of Eminere 1 (@ 230 V And 40 m Cable) Via 1 Output		
		E-Box Daisy	144 Of Eminere 1 (@ 230 V And 40 m Cable) Via 1 Output		
E-Box Star		144 Of Eminere 1 (@ 230 V And 40 m Cable) Via 6 Outputs			
Physical	Width × Height × Length	Eminere 1	76 × 107 × 329 (2.99 × 3.58 × 12.95 In.)		
		Eminere 2	76 × 107 × 629 (2.99 × 3.58 × 24.76 In.)		
		Eminere 3	76 × 107 × 929 (2.99 × 3.58 × 36.57 In.)		
		Eminere 4	76 × 107 × 1229 (2.99 × 3.58 × 48.38 In.)		
	Weight	2.5 Kg / 5.5 lbs	4 Kg / 8.8 lbs	6.0 Kg / 13.3 lbs	7.7 Kg / 17 lbs
	Housing	High Pressure Extruded Aluminium Body End Caps – Die-Cast Aluminium Tempered Glass			
	Finish Options	Standard Colour – Graphite Black (RAL 9011) Silver (RAL 9006)			
		Cost Option – Custom RAL Harsh Environment (RAL 9016, RAL 9011)			
	Cables / Connections	IP67 Hybrid Connection (Power + Data)			
	Mounting Method	Surface Mount With Different Type Of Brackets			
	Adjustability	±95°			
	Protection Factor	IP67 / Suitable For Wet Locations			
	IK Rating	IK06			
	Cooling System	Convection			
Operating Ambient Temperature	–20 °C / +40 °C (–4 °F / +104 °F)				
Operating Temperature	+67 °C @ Ambient +40 °C (+153 °F @ Ambient +104 °F)				
Certification	Listings	ETL / cETL, CE, RoHS, UKCA			

Eminere™ Side

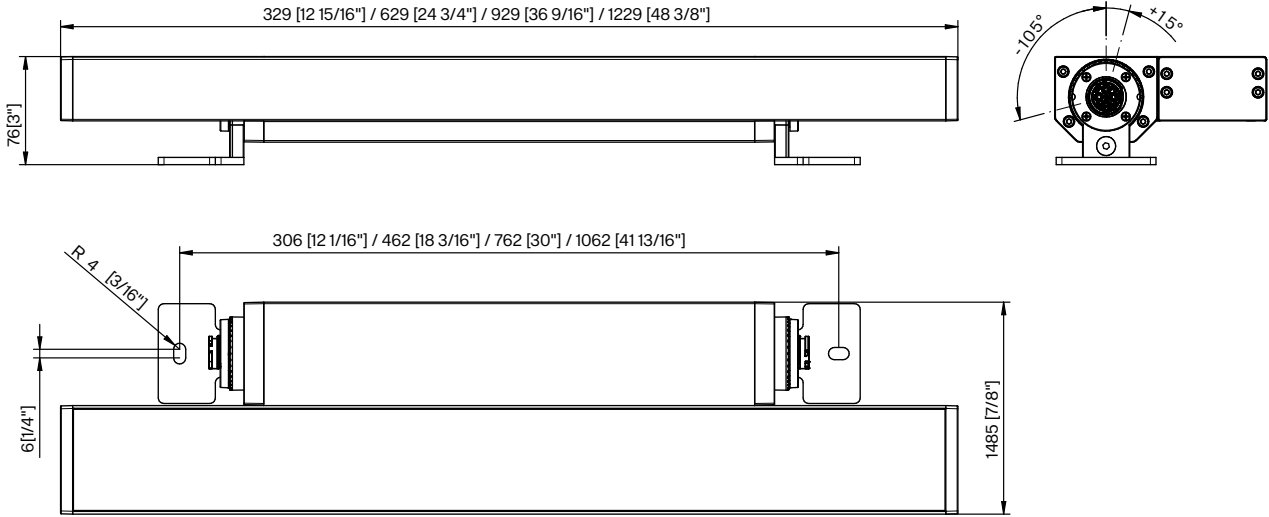

Luminous emittance 1 / Polar LDC

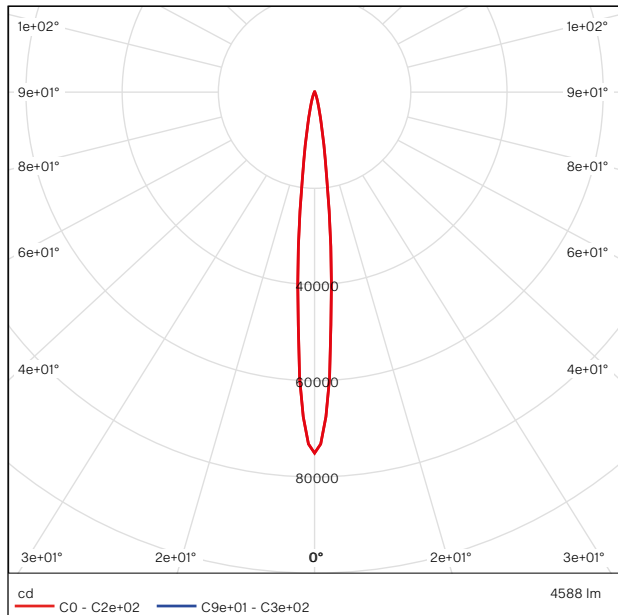

Luminous emittance 1 / Cone diagram

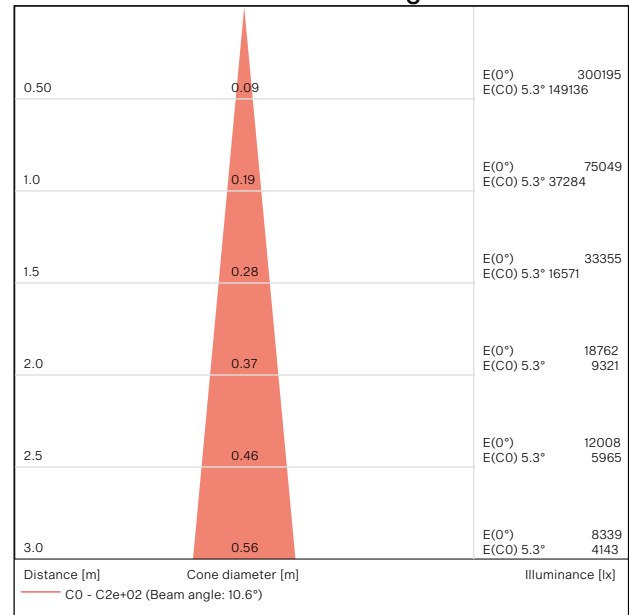

Electrical	Input Voltage	120–277 V AC 50/60 Hz			
	Typical Power Consumption	Eminere Side 1	25 W		
		Eminere Side 2	45 W		
		Eminere Side 3	65 W		
		Eminere Side 4	85 W		
Optical	Light Source	12, 24, 36, 48 × High Power Single Chip LEDs			
	Colour Variants	RGBW (W – 6500 K) RGBA PW (W – 3000 K)			
		Variants On Request (TW (2700–6500 K), 2200 K 2500 K 2700 K 3500 K 4000 K 5000 K 6500 K)			
	Beam Angle	Symmetrical:	9° 15° 30° 50° 65° 100°		
		Bi-symmetrical:	10° × 30° 30° × 10° 10° × 60° 60° × 10° 35° × 70° 70° × 35° 15° × 90° 90° × 15°		
		Asymmetrical:	Wallwasher Wide Wallwasher		
Lumen Output Delivered	Eminere Side 1	1147 lm, RGBW @ 9°			
	Eminere Side 2	2294 lm, RGBW @ 9°			
	Eminere Side 3	3441 lm, RGBW @ 9°			
	Eminere Side 4	4588 lm, RGBW @ 9°			
Projected Lumen Maintenance	L90B10 >90.000 hrs, Ta = 25°C / 77°F				
Control	Interface Protocol	Via E-Box range or Wireless DMX (excluded Eminere Side 1)			
	E-Box Control Protocols	USITT DMX512, RDM, ArtNet, MA Net, MA Net2, sACN, Kling-Net			
	Wireless DMX (Option)	Lumen Radio CRMX Technology			
	Operating Modes	Pixel (12 LEDs / 300 mm) or Fixture mode			
	Setting / Addressing	Via Two Row LCD Display with Control Buttons or RDM communicator			
	Power Supply	Integrated			
	Connectivity	E-Box Lite	144 of Eminere Side 1 (@ 230 V and 40 m cable) via 1 Output		
		E-Box Daisy	144 of Eminere Side 1 (@ 230 V and 40 m cable) via 1 Output		
E-Box Star		144 of Eminere Side 1 (@ 230 V and 40 m cable) via 6 Outputs			
Physical	Width × Height × Length	Eminere Side 1	148 × 76 × 329 mm (5.82 × 2.99 × 12.95 in.)		
		Eminere Side 2	148 × 76 × 629 mm (5.82 × 2.99 × 24.76 in.)		
		Eminere Side 3	148 × 76 × 929 mm (5.82 × 2.99 × 36.57 in.)		
		Eminere Side 4	148 × 76 × 1229 mm (5.82 × 2.99 × 48.38 in.)		
	Weight	2.95 kg / 6.5 lbs	4.75 kg / 10.47 lbs	7 kg / 15.43 lbs	8.92 kg / 19.67 lbs
	Housing	High Pressure Extruded Aluminium Body End Caps – Die-Cast Aluminium Tempered Glass			
	Finish Options	Standard Colour		Graphite Black (RAL 9011) Silver (RAL 9006)	
		Cost Option		Custom RAL Harsh Environment (RAL 9016, RAL 9011)	
	Cables / Connections	IP67 Hybrid Connection (Power + Data)			
	Mounting Method	Surface Mount With Different Type of Brackets			
	Adjustability	–150° / +15°			
	Protection Factor	IP67 / Suitable For Wet Locations			
	IK Rating	IK06			
Cooling System	Convection				
Operating Ambient Temperature	–20 °C / +40 °C (–4 °F / +104 °F)				
Operating Temperature	+67 °C @ Ambient +40 °C (+153 °F @ Ambient +104 °F)				
Certification	Listings	ETL / cETL, CE, RoHS, UKCA			

Eminere™ Inground

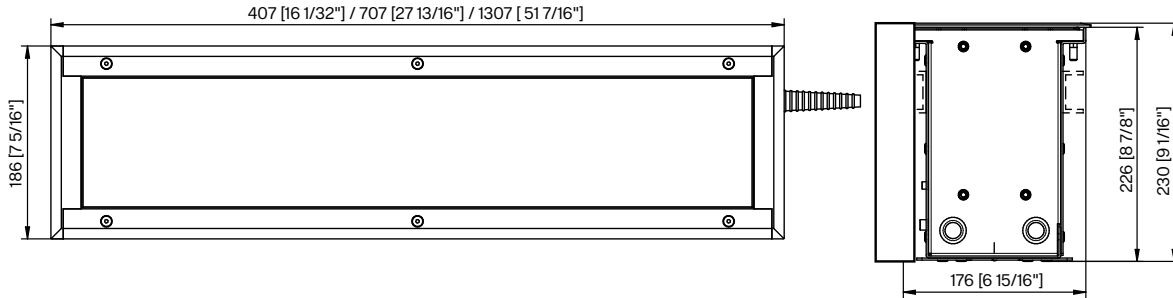

Eminere 4 RGBCW Inground Anti-Skid

Luminous emittance 1 / Polar LDC

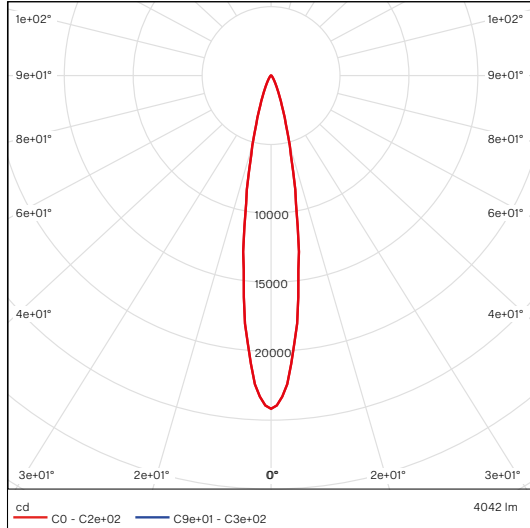

Luminous emittance 1 / Cone diagram

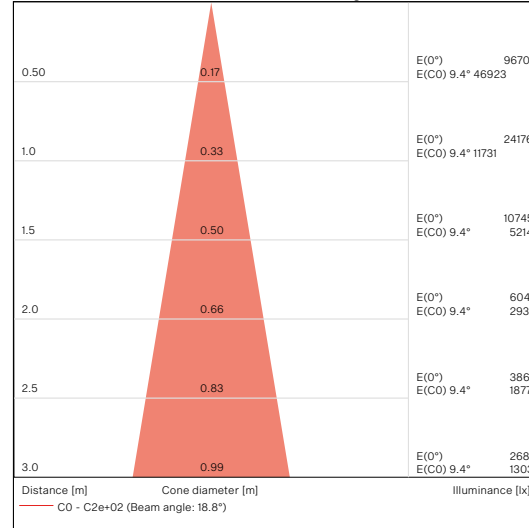

Eminere 4 RGBCW Inground Pure Glass

Luminous emittance 1 / Polar LDC

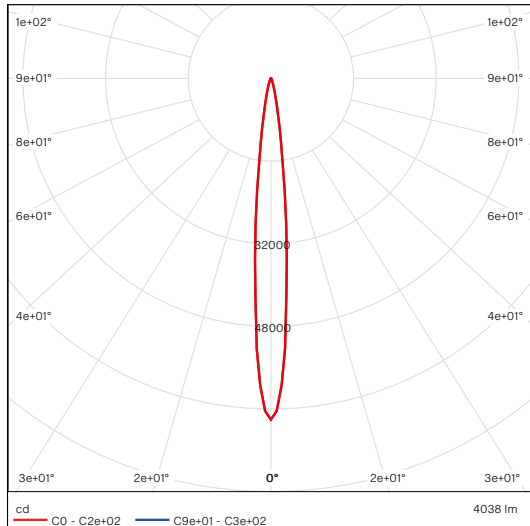

Luminous emittance 1 / Cone diagram

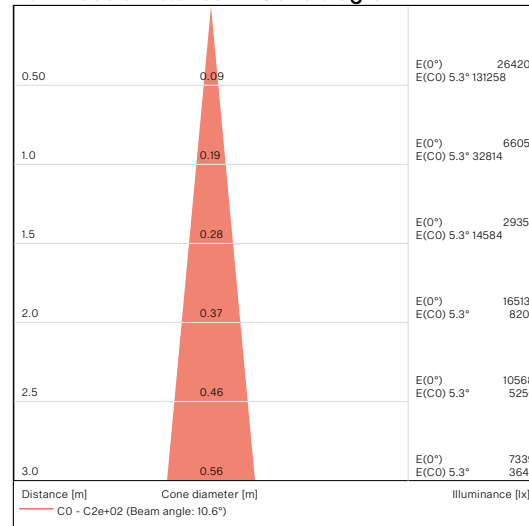

Electrical	Input Voltage	120–277 V AC 50/60 Hz		
	Typical Power Consumption	Eminere Inground 1: 30 W	Eminere Inground 2: 50 W	Eminere Inground 4: 90 W
Optical	Light Source	12, 24, 48 × High Power Single Chip LEDs		
	Colour Variants	RGBW (W – 6.500 K) RGBA PW (W – 3.000 K) Variants On Request (TW (2700 – 6500 K) 2500 K 2700 K 3500 K 4000 K 5000 K 6500 K)		
	Beam Angle	Symmetrical	Clear Glass: 9° 15° 30° 50° 65° 100° Anti-Skid: 18° 22° 35° 50° 65° 100°	
		Bi-symmetrical	Clear Glass: 10° × 30° 10° × 60° 15° × 90° 35° × 70° Anti-Skid: 20° × 35° 20° × 65° 20° × 90° 40° × 70°	
		Asymmetrical:	Wallwasher Wide Wallwasher	
Lumen Output Delivered	Eminere Inground 1	1008 lm, RGBW @ 9° (Clear Glass) 1010 lm, RGBW @ 18° (Anti-Skid)		
	Eminere Inground 2	2019 lm, RGBW @ 9° (Clear Glass) 2021 lm, RGBW @ 18° (Anti-Skid)		
	Eminere Inground 4	4038 lm, RGBW @ 9° (Clear Glass) 4042 lm, RGBW @ 18° (Anti-Skid)		
	Projected Lumen Maintenance	L90B10 >90.000 hrs, Ta = 25°C / 77°F		
Control	Interface Protocol	Via E-Box range or Wireless DMX		
	E-Box Control Protocols	USITT DMX512, RDM, ArtNet, MA Net, MA Net2, sACN, Kling-Net		
	Wireless DMX (Option)	Lumen Radio CRMX Technology		
	Operating Modes	Pixel (12 LEDs / 300 mm) or Fixture mode		
	Setting / Addressing	Via Two Row LCD Display with Control Buttons or RDM communicator		
	Power Supply	Integrated		
	Connectivity	E-box Lite	Max. 32 pcs of Eminere Inground 1/ 2 / 4	
Physical	Width × Height × Length	Eminere Inground 1 / 2 / 4:	186 × 230 × 407 / 707 / 1307 mm (7.32 × 9.05 × 16.02 / 27.83 / 51.46 in.)	
	Weight	12.5 kg / 27.65 lbs	(6.8 kg / 15 lbs Eminere Inground 1 Fixture, 6.6 kg / 14.5 lbs Install. Sleeve)	
		23.6 kg / 52 lbs	(12.2 kg / 26 lbs Eminere Inground 2 Fixture, 11.4 kg / 25 lbs Install. Sleeve)	
		43.85 kg / 96.67 lbs	(22.65 kg / 49.93 lbs Eminere Inground 4 Fixture, 21.2 kg / 46.74 lbs Install. Sleeve)	
	Housing	High Pressure Extruded Aluminium Body End Caps – Die-Cast Aluminium Tempered Glass Anti-Skid (Option) Stainless Steel Instalation sleeve for pre-instalation		
	Finish Options	Stainless Steel Flange Housing Standard Colour – Graphite Black (RAL 9011)		
	Connections	Junction Box		
	Mounting Method	Inground mount		
	Adjustability	±15° after instalation		
	Protection Factor	IP67 / Suitable For Wet Locations		
	IK Rating	IK09		
	Max. Static Load	Standard Tempered Glass: 45kN Anti-Skid Tempered Glass: 23kN		
	Cooling System	Convection		
	Operating Ambient Temperature	–20 °C / +40 °C (–4 °F / +104 °F)		
	Operating Temperature	+80 °C @ Ambient +40 °C (+176 °F @ Ambient +104 °F)		
Certification	Listings	ETL / cETL, CE, RoHS, UKCA		
Accessories	Mounting	Eminere Inground Mounting Sleeve		
		Eminere Inground Cover Plate Continuous (always packed with 1 × Cover Plate Middle)		
		Eminere Inground Cover Plate End		
Cables	Cable CE WCA Cable US WCA			

Eminere™ Remote

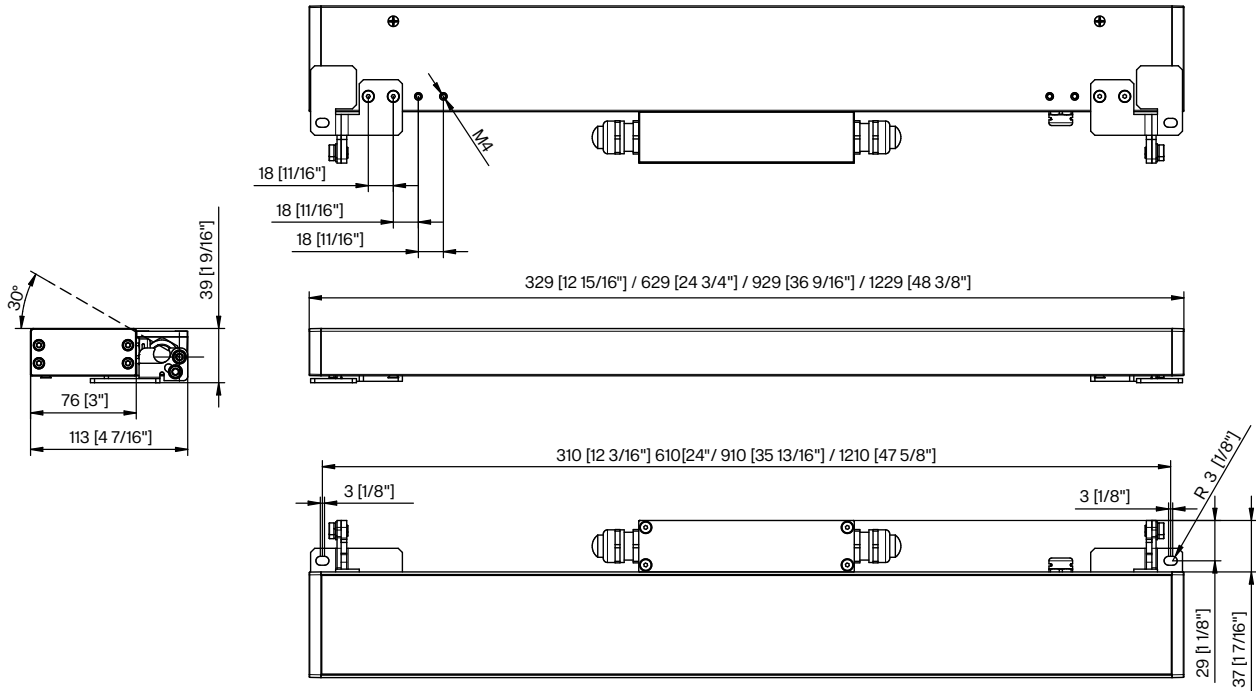

Luminous emittance 1 / Polar LDC

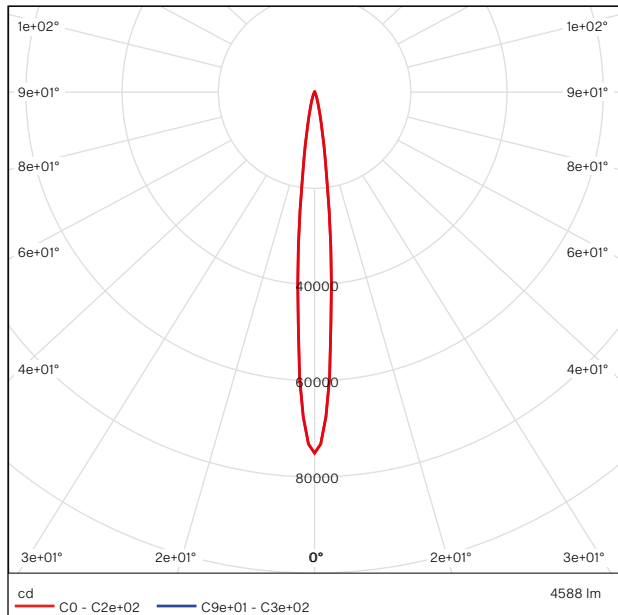

Luminous emittance 1 / Cone diagram

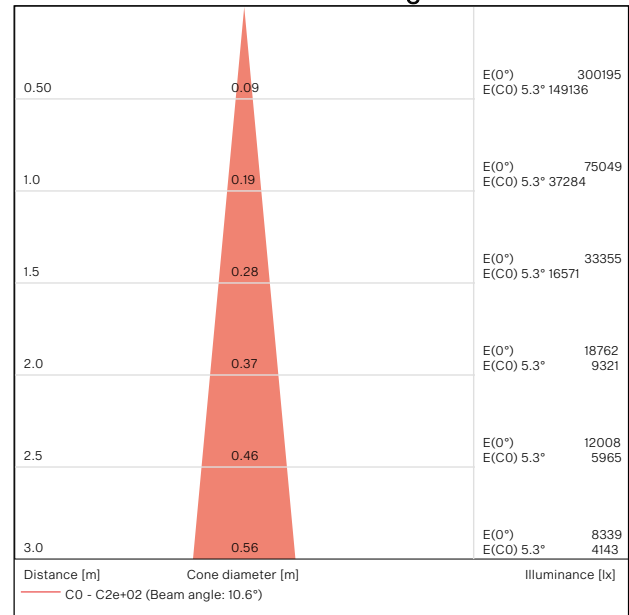

Electrical	Input Voltage	48 V			
	Typical Power Consumption	Eminere Remote 1	20 W		
		Eminere Remote 2	40 W		
		Eminere Remote 3	60 W		
		Eminere Remote 4	80 W		
Optical	Light Source	12, 24, 36, 48 × High Power Single Chip LEDs			
	Colour Variants	RGBW (W – 6500 K) RGBA PW (W – 3000 K)			
		Variants On Request (TW (2700–6500 K) 2200 K 2500 K 2700 K 3500 K 4000 K 5000 K 6500 K)			
	Beam Angle	Symmetrical:	9° 15° 30° 50° 65° 100°		
		Bi-symmetrical:	10° × 30° 30° × 10° 10° × 60° 60° × 10° 35° × 70° 70° × 35° 15° × 90° 90° × 15°		
		Asymmetrical:	Wallwasher Wide Wallwasher		
	Lumen Output Delivered	Eminere Remote 1	1147 lm, RGBW @ 9°		
Eminere Remote 2		2294 lm, RGBW @ 9°			
Eminere Remote 3		3441 lm, RGBW @ 9°			
Eminere Remote 4		4588 lm, RGBW @ 9°			
Projected Lumen Maintenance	L90B10 > 90.000 hrs, Ta = 25°C / 77°F				
Control	Interface Protocol	Via E-Box Remote range			
	E-Box Remote Control Protocols	USITT DMX512, RDM, ArtNet, MA Net, MA Net2, sACN, Kling-Net			
	Operating Modes	Pixel (12 LEDs / 300 mm) or Fixture mode			
	Setting / Addressing	Via Two Row LCD Display with Control Buttons on E-Box Remote or RDM communicator			
	Power Supply	Via E-Box Remote range			
	Connectivity	E-Box Remote	16 pcs of Eminere Remote 1 (50 m cable – total length) via 1 Output,		
		E-Box Remote Basic	20 pcs in total for both Outputs (25 m cable – total length)		
Physical	Width × Height × Length	Eminere Remote 1	113 × 39 × 329 mm (4.45 × 1.54 × 12.95 in.)		
		Eminere Remote 2	113 × 39 × 629 mm (4.45 × 1.54 × 24.76 in.)		
		Eminere Remote 3	113 × 39 × 929 mm (4.45 × 1.54 × 36.57 in.)		
		Eminere Remote 4	113 × 39 × 1229 mm (4.45 × 1.54 × 48.39 in.)		
	Weight	2 kg 4.41 lbs	3.1 kg 6.83 lbs	4.1 kg 9.04 lbs	5.1 kg 11.24 lbs
	Housing	High Pressure Extruded Aluminium Body End Caps – Die-Cast Aluminium Tempered Glass			
	Finish Options	Standard Colour	Graphite Black (RAL 9011) Silver (RAL 9006)		
		Cost Option	Custom RAL Harsh Environment (RAL 9016, RAL 9011)		
	Cables / Connections	Integrated Junction Box			
	Mounting Method	Surface Mount With Different Type of Brackets			
	Adjustability	+30°			
	Protection Factor	IP67 / Suitable For Wet Locations			
	IK Rating	IK06			
	Cooling System	Convection			
	Operating Ambient Temperature	-20 °C / +40 °C (-4 °F / +104 °F)			
	Operating Temperature	+67 °C @ Ambient +40 °C (+153 °F @ Ambient +104 °F)			
Certification	Listings	ETL / cETL, CE, RoHS, UKCA			
Accessories	Cable for Eminere Remote – bare end (custom length)				
	Mounting Brackets	Mounting Brackets 100 200 300 mm			
		Mounting Brackets – custom length			
	Shields	Shield For Eminere Remote 1 2 3 4			

Eminere™ UV

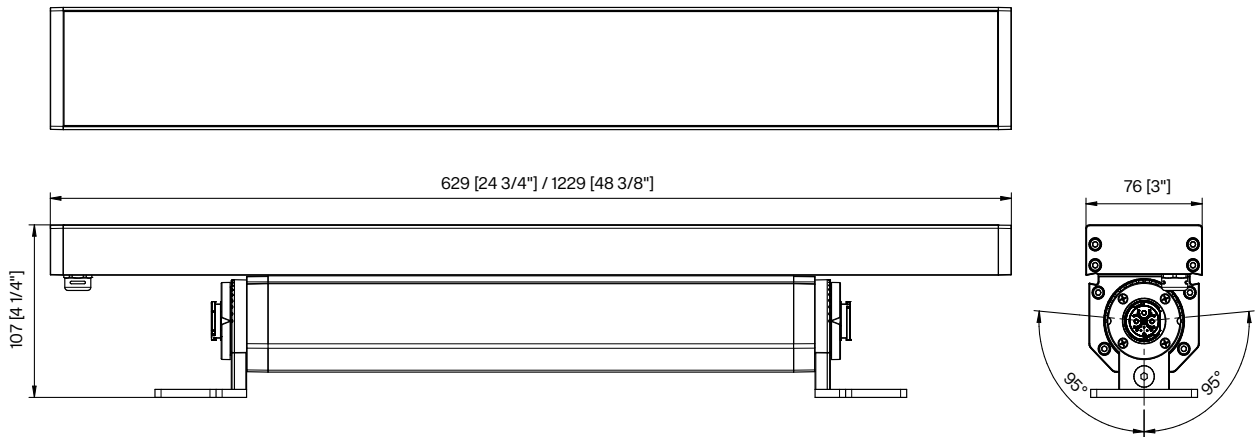

Electrical	Input Voltage	120–277 V AC 50/60 Hz		
	Typical Power Consumption	Eminere UV 2	45 W	
		Eminere UV 4	85 W	
Optical	Light Source	Eminere UV 2: 16 × UV LEDs		
		Eminere UV 4: 32 × UV LEDs		
	UV LEDs Wave Length	365 nm		
	Beam Angle	Optic: 38° Non-optic: 120°		
	LEDs lifetime	10,000 hrs		
Control	Interface Protocol	Via E-Box range or Wireless DMX		
	E-Box Control Protocols	E-Box With Self Addressing Feature or Custom Setting Via LCD Display		
	Wireless DMX (Option)	Lumen Radio CRMX Technology		
	Settings / Addressing	Via Two Row LCD Display with Control Buttons or RDM communicator		
	Power Supply	Integrated		
	Connectivity	E-Box Lite	78 of Eminere UV 2 (@ 230 V and 30 m cable) via 1 Output	
		E-Box Daisy	78 of Eminere UV 2 (@ 230 V and 30 m cable) via 1 Output	
E-Box Star		78 of Eminere UV 2 (@ 230 V and 30 m cable) via 1 Output		
Physical	Width × Height × Length	Eminere UV 2	76 × 107 × 629 mm (2.99 × 3.58 × 24.76 in.)	
		Eminere UV 4	76 × 107 × 1229 mm (2.99 × 3.58 × 48.38 in.)	
	Weight	Eminere UV 2	4.05 kg 8.92 lbs	
		Eminere UV 4	7.68 kg 16.93 lbs	
	Housing	High Pressure Extruded Aluminium Body End Caps – Die-Cast Aluminium Tempered Glass		
	Finish Options	Standard Colour – Graphite Black (RAL 9011) Silver (RAL 9006)		
		Cost Option – Custom RAL Harsh Environment (RAL 9016, RAL 9011)		
	Connections	IP67 Hybrid Connection (Power + Data)		
	Mounting Method	Surface Mount With Different Type of Brackets		
	Adjustability	±95°		
	Protection Factor	IP67 / Suitable For Wet Locations		
	IK Rating	IK06		
	Cooling System	Convection		
	Operating Ambient Temperature	-20 °C / +40 °C (-4 °F / +104 °F)		
Operating Temperature	+67 °C @ Ambient +40 °C (+176 °F @ Ambient +104 °F)			
Certification	Listings	ETL / cETL, CE, RoHS, UKCA		
Accessories	Mounting Brackets	Mounting Bracket	50 mm 100 mm 200 mm 300 mm	
		Mounting Bracket	Custom length	
	Optical	Black Glass Adaptor For Eminere UV 2 4		
	Cables	Leader Cable	2 m 5 m 10 m 25 m 50 m	
		Jumper Cable	0.25 m 0.5 m 1 m 2 m 3 m 5 m 10 m	
	Connectors	Field Installable Connector		
		Waterproof End Cap		
	Cable Covers	Cable Cover For Eminere 2 4		
	Shields	Shield For Eminere 2 4		

Eminere™ Remote UV

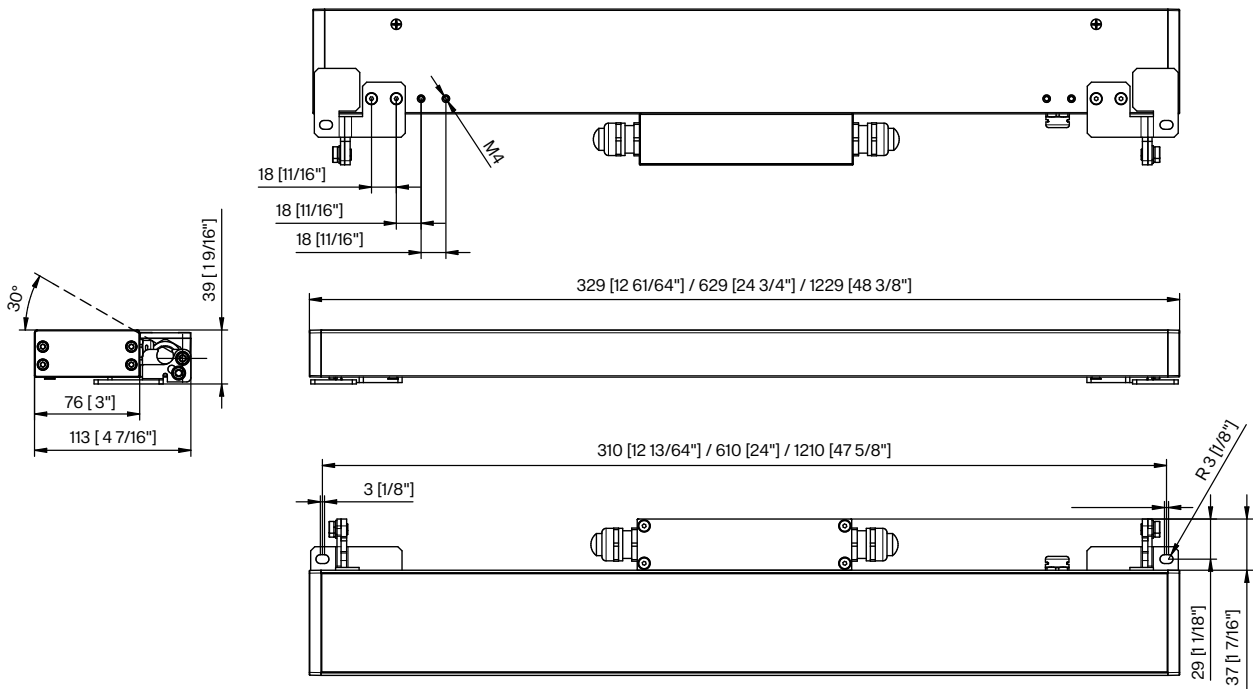

Electrical	Input Voltage	48 V		
	Typical Power Consumption	Eminere Remote UV 1: 20 W	Eminere Remote UV 2: 40 W	Eminere Remote UV 4: 80 W
Optical	Light Source	Eminere Remote UV 1 / 2 / 4: 8 / 16 / 32 × UV LEDs		
	UV-A LEDs Wave Length	365 nm		
	Beam Angle	Optical version: 38°	Non-optical version: 120°	
	LEDs lifetime	10,000 hrs		
Control	Interface Protocol	Via E-Box Remote range		
	E-Box Remote Control Protocols	USITT DMX512, RDM, ArtNet, MA Net, MA Net2, sACN, Kling-Net		
	Settings / Addressing	Via Two Row LCD Display with Control Buttons on E-Box Remote or RDM communicator		
	Power Supply	Via E-Box Remote range		
	Connectivity	E-Box Remote	16 pcs of Eminere Remote UV 1 (50 m cable – total length) via 1 Output	
	E-Box Remote basic	20 pcs in total for both Outputs (25 m cable – total length)		
Physical	Width × Height × Length	Eminere Remote UV 1	113 × 39 × 329 mm (4.45 × 1.54 × 22.95 in.)	
		Eminere Remote UV 2	113 × 39 × 629 mm (4.45 × 1.54 × 24.76 in.)	
		Eminere Remote UV 4	113 × 39 × 1229 mm (4.45 × 1.54 × 48.39 in.)	
	Weight	2 kg 4.41 lbs	3.1 kg 6.83 lbs	5.1 kg 11.24 lbs
	Housing	High Pressure Extruded Aluminium Body		
		End Caps – Die-Cast Aluminium		
		Tempered Glass		
	Finish Options	Standard Colour – Graphite Black (RAL 9011) Silver (RAL 9006)		
		Cost Option – Custom RAL Harsh Environment (RAL 9016, RAL 9011)		
	Cables / Connections	Integrated Junction Box		
	Mounting Method	Surface Mount With Different Type of Brackets		
	Adjustability	+30°		
	Protection Factor	IP67 / Suitable For Wet Locations		
	IK Rating	IK06		
Cooling System	Convection			
Operating Ambient Temperature	-20 °C / +40 °C (-4 °F / +104 °F)			
Operating Temperature	+67°C @ Ambient +40°C (+153°F @ Ambient +104°F)			
Certification	Listings	CE, RoHS, UKCA		
Accessories	Cables	Cabel for Eminere Remote UV – bare end (custom length)		
	Mounting Brackets	Mounting Brackets 100 200 300 mm		
		Mounting Brackets – custom length		
	Shield	Shield For Eminere Remote UV 1 / 2 / 4		
	Optical	Black Glass Adaptor for Eminere Remote UV 1 / 2 / 4		

Calumma™ XS MC

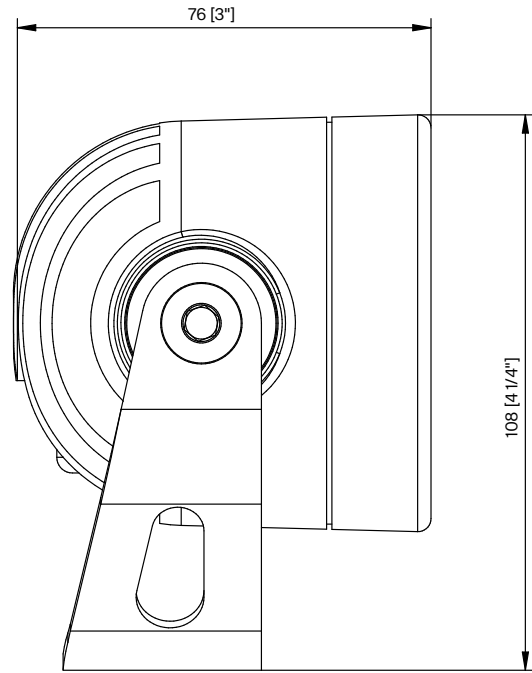
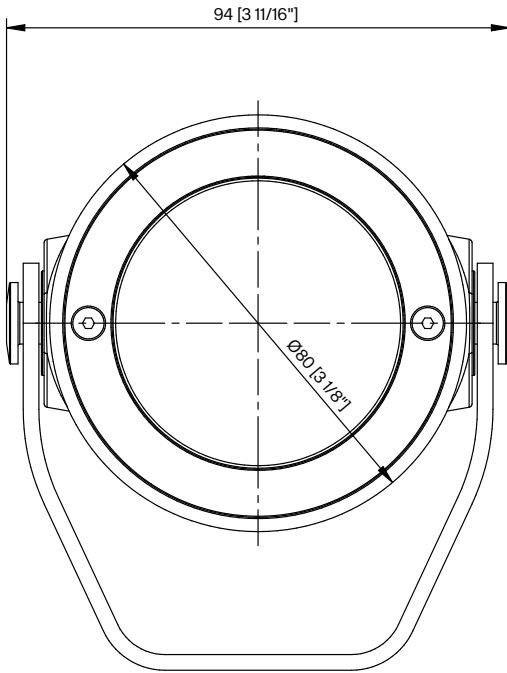

Luminous emittance 1 / Polar LDC

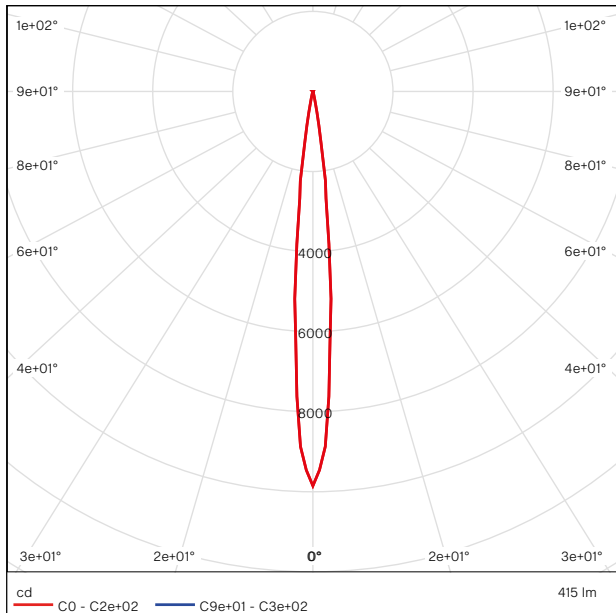

Luminous emittance 1 / Cone diagram

0.50	0.09	E(0°) 39407 E(CO) 5.2° 19468
1.0	0.18	E(0°) 9852 E(CO) 5.2° 4867
1.5	0.27	E(0°) 4379 E(CO) 5.2° 2163
2.0	0.36	E(0°) 2463 E(CO) 5.2° 1217
2.5	0.46	E(0°) 1576 E(CO) 5.2° 779
3.0	0.55	E(0°) 1095 E(CO) 5.2° 541

Distance [m] Cone diameter [m] Illuminance [lx]
 — C0 - C2e+02 (Beam angle: 10.4°)

Electrical	Typical Power Consumption	10 W	
	Input Voltage	48 V	
Optical	Light Source	High Power Multi-chip LED	
	Colour Variants	RGBW (W – 6500 K) RGBA PW (W – 3000 K) Other Variants On Request (TW 2700 – 6500 K)	
	Beam Angle	9° 15° 25° 30° 45° 65° 100° 10° × 30° 30° × 10° 10° × 60° 60° × 10° 15° × 45° 45° × 15° 15° × 90° 90° × 15° 30° × 60° 60° × 30° 30° × 90° 90° × 30°	
	Lumen Output Delivered	415 lm (@9° RGBW)	
	Projected Lumen Maintenance	L90B10 >90.000 hrs, Ta = 25°C / 77°F	
	Control	Interface protocol	Via E-Box Remote or E-Box Remote Basic
	E-Box Remote control protocol	USITT DMX512/RDM, ArtNet, MA Net, MA Net2, sACN, Kling-Net	
	Setting / addressing	E-Box Remote, RDM communicator	
	Connectivity & Power Supply	E-Box Remote Remote Basic	
Physical	Width × Height × Depth	94 × 108 × 76 mm (3.7 × 4.2 × 3 in.)	
	Weight	0.59 kg 1.3 lbs	
	Housing	High Pressure Die-Cast Aluminium Body Tempered Glass	
	Finish Options	Standard Colour – Graphite Black (RAL 9011) Silver (RAL 9006) Cost Option – Custom RAL Harsh Environment (RAL 9016, RAL 9011)	
	Cables / Connectivity	IN – Cable with bare end (Standard 1 m, Longer upon Request) – Cable length – custom – Junction box – optional	
	Mounting Method	Yoke	
	Adjustability	+180° / -180°	
	Protection Factor	IP67 (IP66 Junction Box) / Suitable For Wet Locations	
	IK Rating	IK10	
	Cooling System	Convection	
	Operating Ambient Temperature	-20 °C / +40 °C (-4 °F / +104 °F)	
	Certification	Listings	ETL / cETL, CE, RoHS, UKCA
	Accessories		Optical Demo Set for Calumma XS
		Top Hat Calumma XS	
		Half Top Hat Calumma XS	
		Land Spike for Calumma XS	

Calumma™ S MC

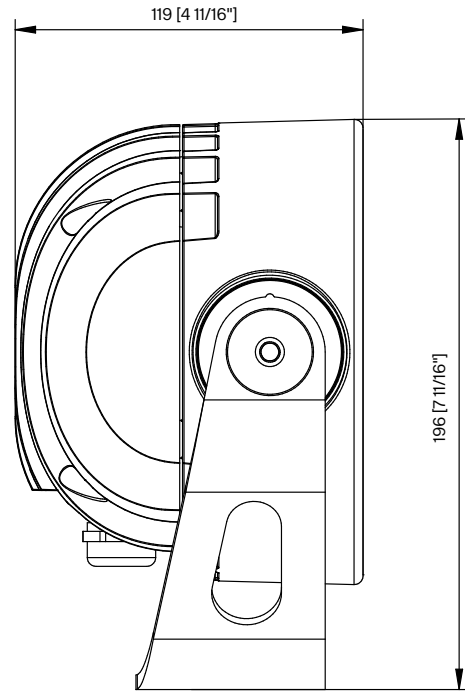
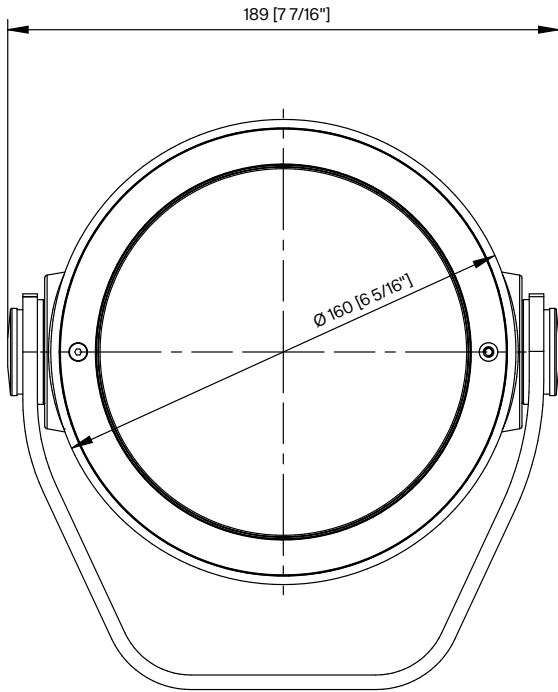

Luminous emittance 1 / Polar LDC

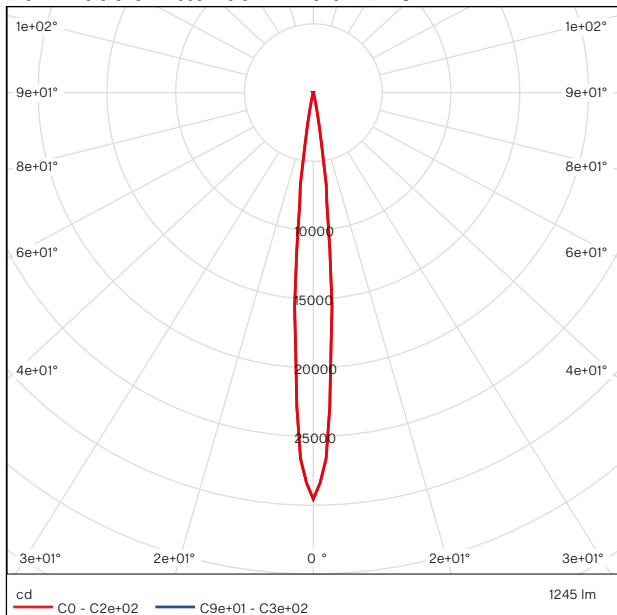

Luminous emittance 1 / Cone diagram

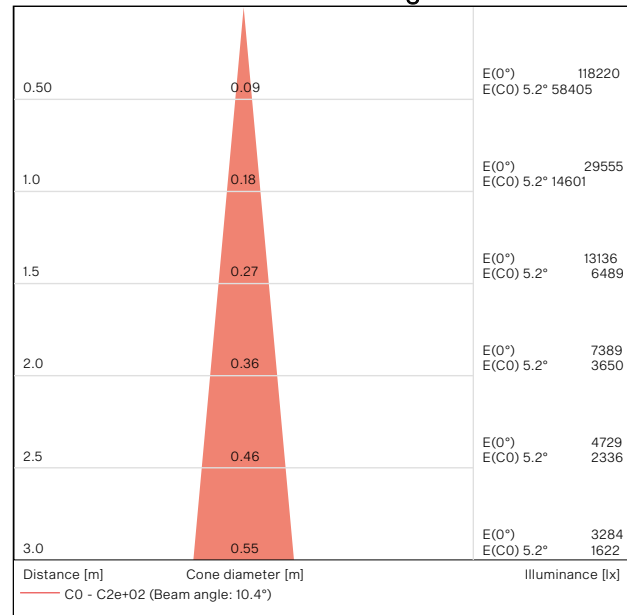

Electrical	Input Voltage	120–277 V AC 50/60 Hz (US)
	Typical Power Consumption	30 W ±10 %
Optical	Light Source	High Power Multi-chip LEDs
	Colour Variants	RGBW (W – 6500 K) RGBA PW (W – 3000 K) Other Variants On Request (TW 2700 – 6500 K)
	Beam Angle	9° 15° 25° 30° 45° 65° 100° 10° × 30° 30° × 10° 10° × 60° 60° × 10° 15° × 45° 45° × 15° 15° × 90° 90° × 15° 30° × 60° 60° × 30° 30° × 90° 90° × 30°
	Lumen Output Delivered	1245 lm (@9° RGBW)
	Projected Lumen Maintenance	L90B10 >90.000 hrs, Ta = 25°C / 77°F
	Control	Interface Protocol
DALI 2 Device Type		DT 8
Control System		Third Party DMX Controllers
Operating Modes		DMX, Stand-alone
Settings / Addressing		E-Box, RDM communicator
Power Supply		Integrated
Physical	Width × Height × Depth	189 × 196 × 119 mm (7.4 × 7.7 × 4.7 in.)
	Weight	3.44 kg 7.6 lbs
	Housing	High Pressure Die-Cast Aluminium Body Tempered Glass
	Finish Options	Standard Colour – Graphite Black (RAL 9011) Silver (RAL 9006) Cost Option – Custom RAL Harsh Environment (RAL 9016, RAL 9011)
	Cables / Connections	IN (for DMX, DALI, ON/OFF): – Cable with bare end – Cable length – custom – Junction box – optional
	Mounting Method	Yoke
	Adjustability	+180° / –180°
	Protection Factor	IP67 (IP66 Junction Box) / Suitable For Wet Locations
	IK Rating	IK10
	Cooling System	Convection
	Operating Ambient Temperature	–20 °C / +40 °C (–4 °F / +104 °F)
Certification	Listings	ETL / cETL, CE, RoHS, UKCA
Accessories		Optical Demo Set for Calumma S
		Top Hat Calumma S
		Half Top Hat Calumma S
		Tenon Adaptor for Calumma S
		Pole Mount Bracket for Calumma S

Calumma™ M MC

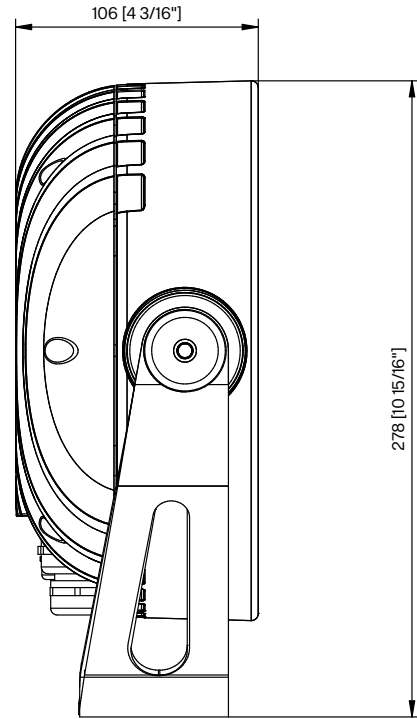
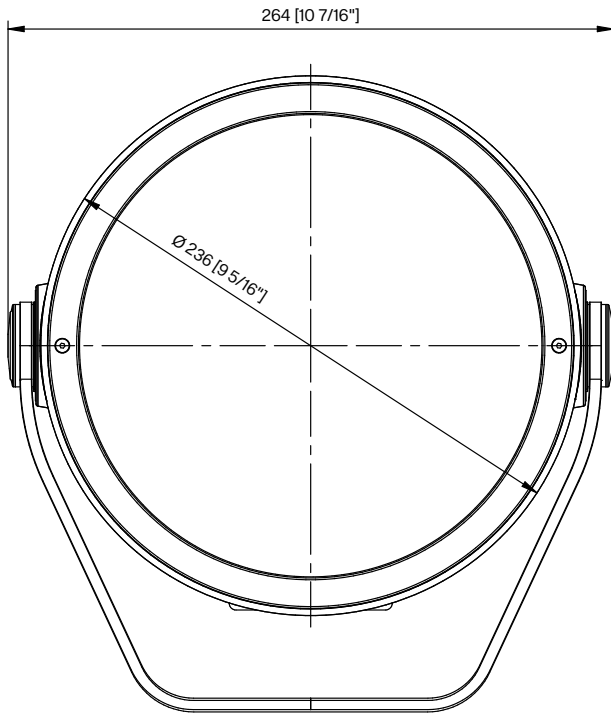

Luminous emittance 1 / Polar LDC

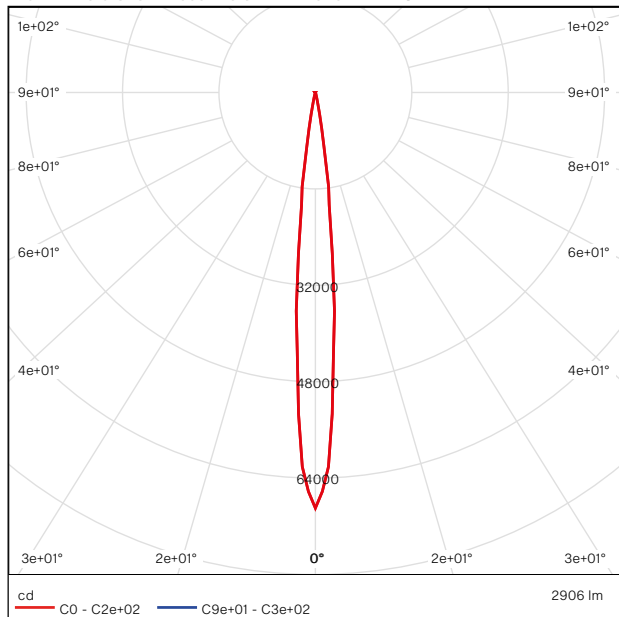

Luminous emittance 1 / Cone diagram

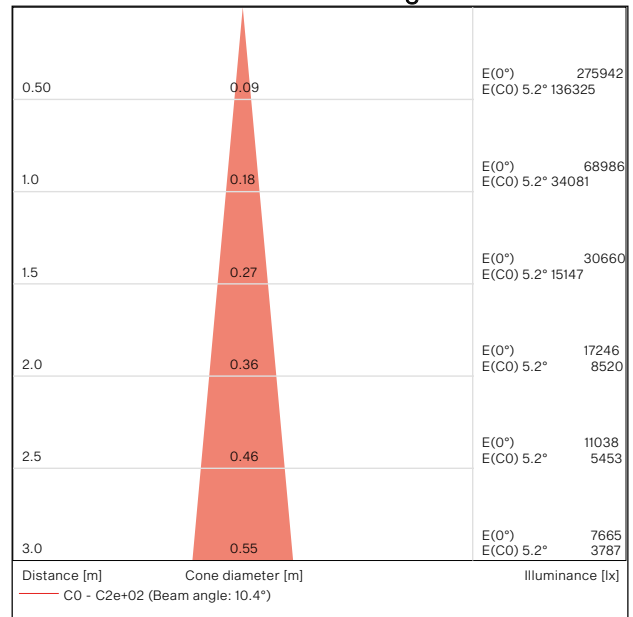

Electrical	Input Voltage	120–277 V AC 50/60 Hz (US)
	Typical Power Consumption	65 W ±10 %
Optical	Light Source	High Power Multi-chip LEDs
	Colour Variants	RGBW (W – 6500 K) RGBA PW (W – 3000 K) Other Variants On Request (TW 2700 – 6500 K)
	Beam Angle	9° 15° 25° 30° 45° 65° 100° 10° × 30° 30° × 10° 10° × 60° 60° × 10° 15° × 45° 45° × 15° 15° × 90° 90° × 15° 30° × 60° 60° × 30° 30° × 90° 90° × 30°
	Lumen Output Delivered	2906 lm (@9° RGBW)
	Projected Lumen Maintenance	L90B10 >90.000 hrs, Ta = 25°C / 77°F
	Control	Interface Protocol
E-Box control protocol		USITT DMX512 + RDM, ArtNet, MA Net, MA Net2, sACN, Kling-Net
DALI 2 Device Type		DT 8
Wireless DMX (Option)		Lumen Radio CRMX Technology
Control System		Third Party DMX Controllers
Operating Modes		DMX, Stand-alone
Settings / Addressing		E-Box, RDM communicator
Power Supply		Integrated
Physical	Width × Height × Depth	264 × 278 × 106 mm (10.4 × 10.94 × 4.17 in.)
	Weight	5.77 kg 12.72 lbs
	Housing	High Pressure Die-Cast Aluminium Body Tempered Glass
	Finish Options	Standard Colour – Graphite Black (RAL 9011), Silver (RAL 9006) Cost Option – Custom RAL Harsh Environment (RAL 9016, RAL 9011)
	Cables / Connections	IN/OUT (for E-Box version): – 0,5 m cables with hybrid connectors – Jumper cables IN (for DMX, DALI, ON/OFF): – Cable with bare end – Cable length – custom – Junction box – optional
	Mounting Method	Yoke
	Adjustability	+180° / -180°
	Protection Factor	IP67 (IP66 Junction Box) / Suitable For Wet Locations
	IK Rating	IK10
	Cooling System	Convection
	Operating Ambient Temperature	-20 °C / +40 °C (-4 °F / +104 °F)
Certification	Listings	ETL / cETL, CE, RoHS, UKCA
Accessories		Optical Demo Set for Calumma M
		Top Hat Calumma M
		Half Top Hat Calumma M
		Tenon Adaptor for Calumma M
		Pole Mount Bracket for Calumma M

Calumma™ L MC

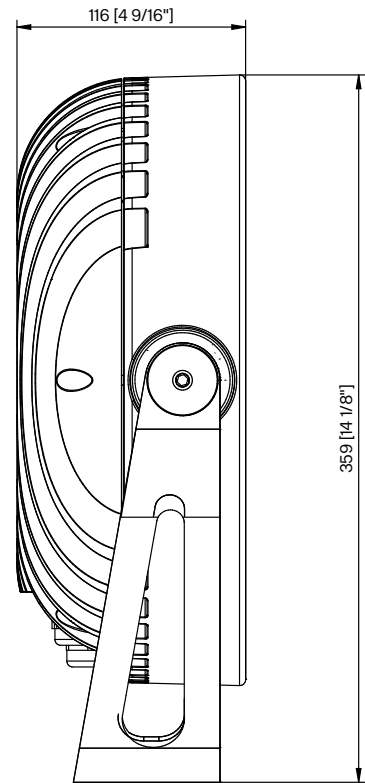
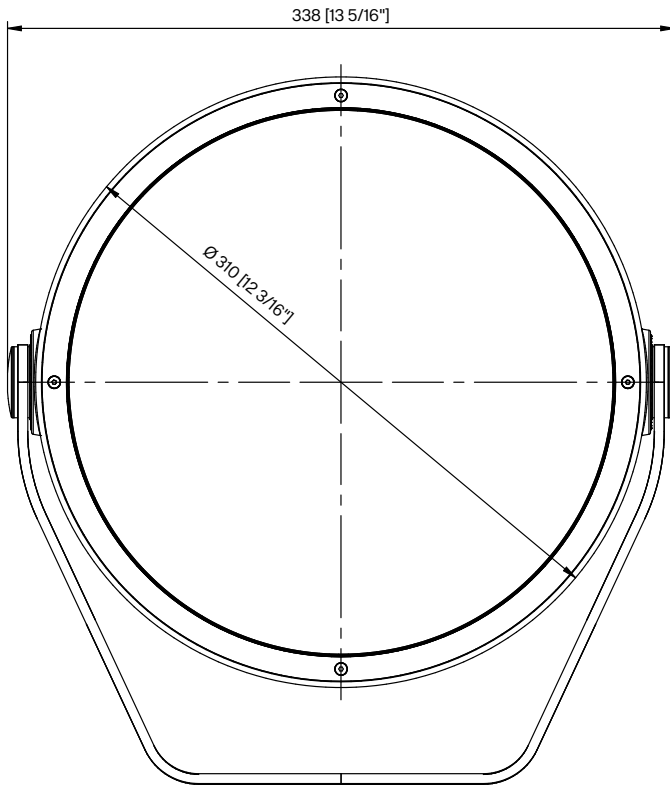

Luminous emittance 1 / Polar LDC

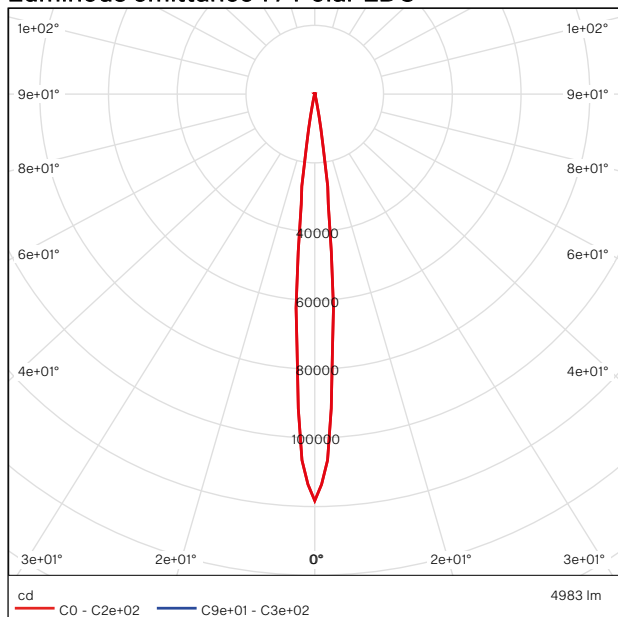

Luminous emittance 1 / Cone diagram

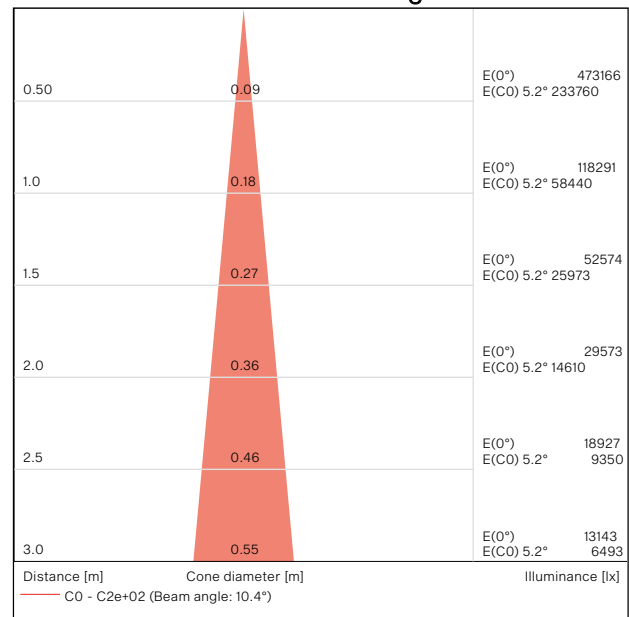

Electrical	Input Voltage	120–277 V AC 50/60 Hz (US)
	Typical Power Consumption	110 W ±10 %
Optical	Light Source	High Power Multi-chip LEDs
	Colour Variants	RGBW (W – 6500 K) RGBA PW (W – 3000 K) Other Variants On Request (TW 2700 – 6500 K)
	Beam Angle	9° 15° 25° 30° 45° 65° 100° 10° × 30° 30° × 10° 10° × 60° 60° × 10° 15° × 45° 45° × 15° 15° × 90° 90° × 15° 30° × 60° 60° × 30° 30° × 90° 90° × 30°
	Lumen Output Delivered	4983 lm (@9° RGBW)
	Projected Lumen Maintenance	L90B10 >90.000 hrs, Ta = 25°C / 77°F
	Control	Interface Protocol
E-Box control protocol		USITT DMX512 + RDM, ArtNet, MA Net, MA Net2, sACN, Kling-Net
DALI 2 Device Type		DT 8
Wireless DMX (Option)		Lumen Radio CRMX Technology
Control System		Third Party DMX Controllers
Operating Modes		DMX, Stand-alone
Settings / Addressing		E-Box, RDM communicator
Power Supply		Integrated
Physical	Width × Height × Depth	338 × 360 × 116 mm (13.31 × 14.13 × 4.57 in.)
	Weight	9.43 kg 20.79 lbs
	Housing	High Pressure Die-Cast Aluminium Body Tempered Glass
	Finish Options	Standard Colour – Graphite Black (RAL 9011) Silver (RAL 9006) Cost Option – Custom RAL Harsh Environment (RAL 9016, RAL 9011)
	Cables / Connections	IN/OUT (for E-Box version): – 0,5 m cables with hybrid connectors – Jumper cables IN (for DMX, DALI, ON/OFF): – Cable with bare end – Cable length – custom – Junction box – optional
	Mounting Method	Yoke
	Adjustability	+180° / –180°
	Protection Factor	IP67 (IP66 Junction Box) / Suitable For Wet Locations
	IK Rating	IK10
	Cooling System	Convection
Operating Ambient Temperature	–20 °C / +40 °C (–4 °F / +104 °F)	
Certification	Listings	ETL / cETL, CE, RoHS, UKCA
Accessories		Optical Demo Set for Calumma L
		Top Hat Calumma L
		Half Top Hat Calumma L
		Tenon Adaptor for Calumma L
		Pole Mount Bracket for Calumma L

Calumma™ XL MC

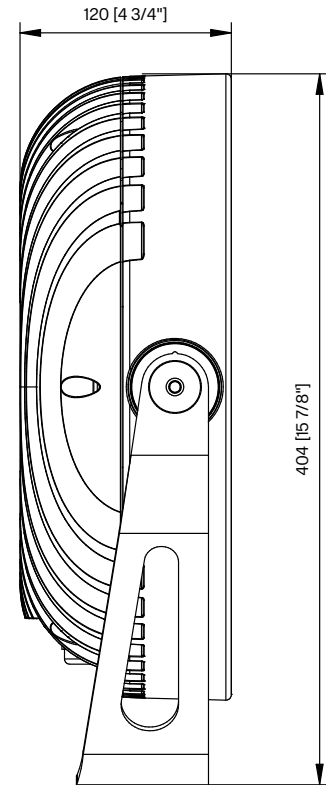
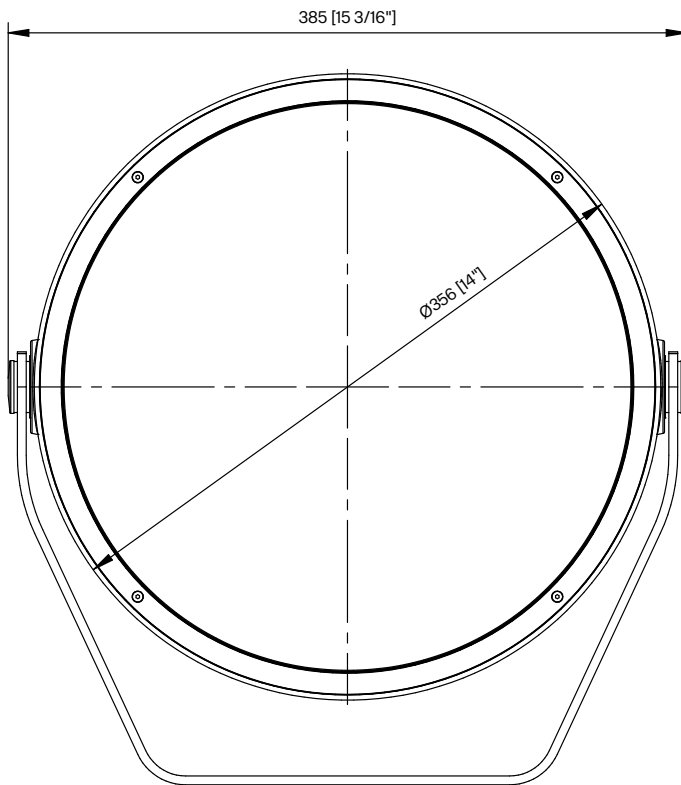

Luminous emittance 1 / Polar LDC

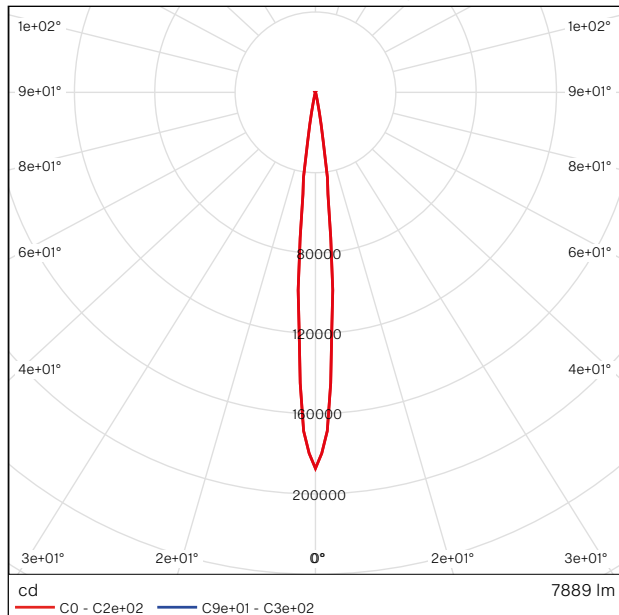

Luminous emittance 1 / Cone diagram

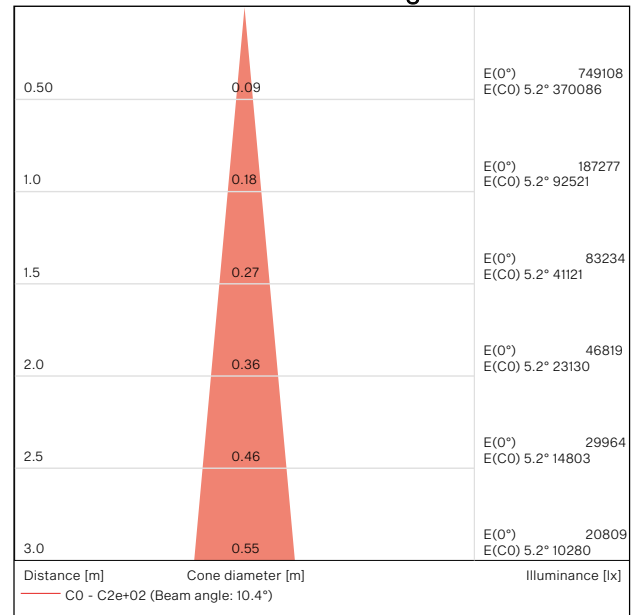

Electrical	Input Voltage	120–277 V AC 50/60 Hz (US)
	Typical Power Consumption	175 W ±10 %
Optical	Light Source	High Power Multi-chip LEDs
	Colour Variants	RGBW (W – 6500 K) RGBA PW (W – 3000 K) Other Variants On Request (TW 2700 – 6500 K)
	Beam Angle	9° 15° 25° 30° 45° 65° 100° 10° × 30° 30° × 10° 10° × 60° 60° × 10° 15° × 45° 45° × 15° 15° × 90° 90° × 15° 30° × 60° 60° × 30° 30° × 90° 90° × 30°
	Lumen Output Delivered	7889 lm (@9° RGBW)
	Projected Lumen Maintenance	L90B10 >90.000 hrs, Ta = 25°C / 77°F
	Control	Interface Protocol
E-Box control protocol		USITT DMX512 + RDM, ArtNet, MA Net, MA Net2, sACN, Kling-Net
DALI 2 Device Type		DT 8
Wireless DMX (Option)		Lumen Radio CRMX Technology
Control System		Third Party DMX Controllers
Operating Modes		DMX, Stand-alone
Settings / Addressing		E-Box, RDM communicator
Power Supply		Integrated
Physical	Width × Height × Depth	385 × 404 × 120 mm (15.16 × 15.91 × 4.72 in.)
	Weight	12.3 kg 27.12 lbs
	Housing	High Pressure Die-Cast Aluminium Body Tempered Glass
	Finish Options	Standard Colour – Graphite Black (RAL 9011) Silver (RAL 9006) Cost Option – Custom RAL Harsh Environment (RAL 9016, RAL 9011)
	Cables / Connections	IN/OUT (for E-Box version): – 0,5 m cables with hybrid connectors – Jumper cables IN (for DMX, DALI, ON/OFF): – Cable with bare end – Cable length – custom – Junction box – optional
	Mounting Method	Yoke
	Adjustability	+180° / –180°
	Protection Factor	IP67 (IP66 Junction Box) / Suitable For Wet Locations
	IK Rating	IK10
	Cooling System	Convection
Operating Ambient Temperature	–20 °C / +40 °C (–4 °F / +104 °F)	
Certification	Listings	ETL / cETL, CE, RoHS, UKCA
Accessories		Optical Demo Set for Calumma XL
		Top Hat Calumma XL
		Half Top Hat Calumma XL
		Tenon Adaptor for Calumma XL
		Pole Mount Bracket for Calumma XL

Calumma™ S SC

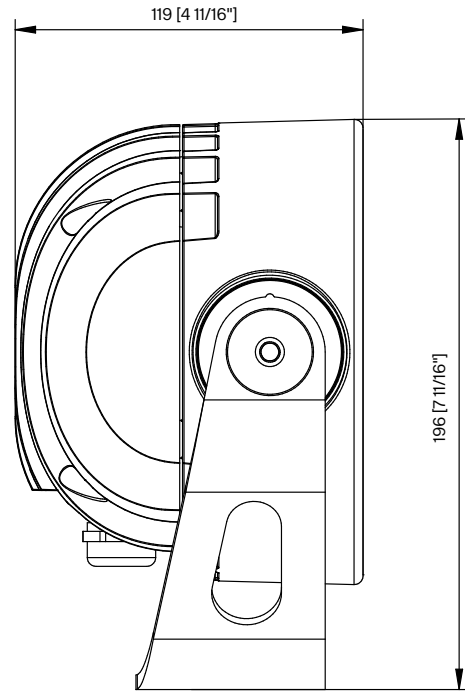
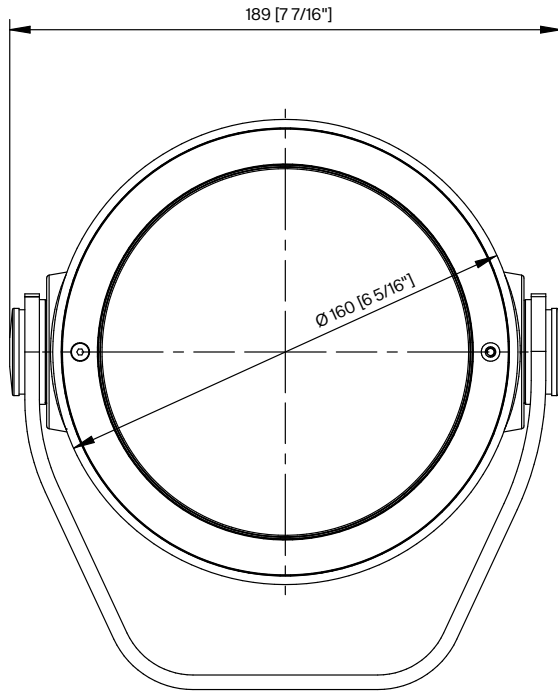

Luminous emittance 1 / Polar LDC

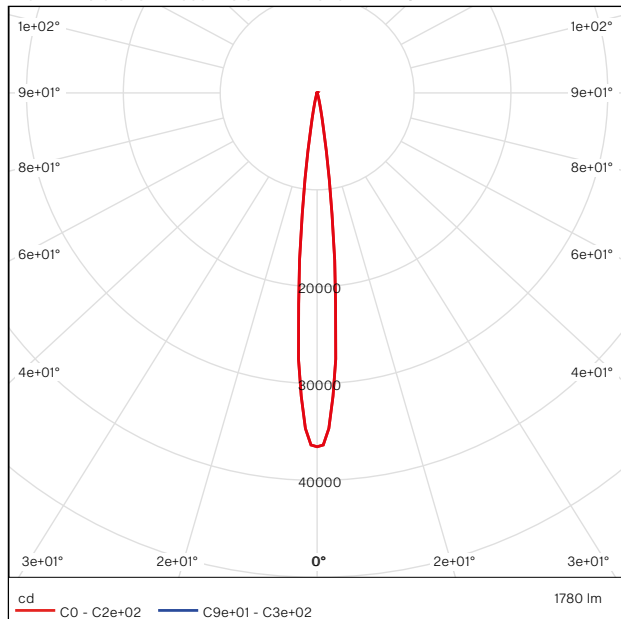

Luminous emittance 1 / Cone diagram

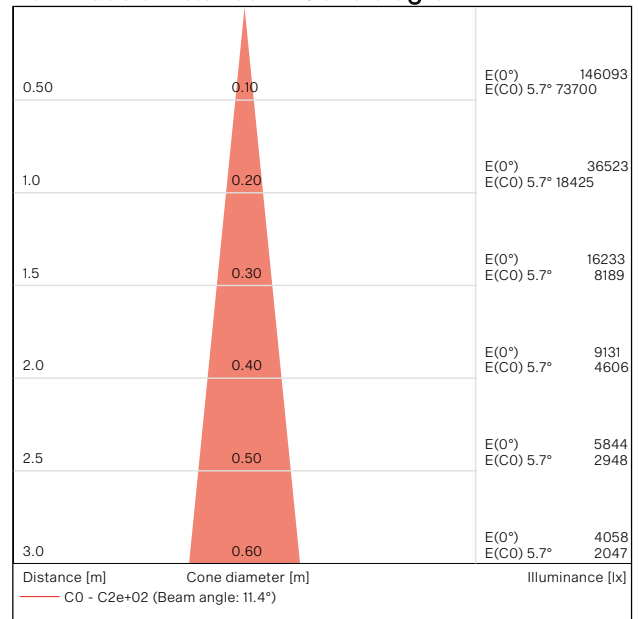

Electrical	Input Voltage	120–277 V AC 50/60 Hz (US)	
	Typical Power Consumption	30 W ±10 %	
Optical	Light Source	High Power Single Chip LEDs	
	Colour Variants	RGBW (W – 6500 K) RGBA PW (W – 3000 K) Other Variants On Request (TW (2700–6500 K), 2200 K, 2500 K, 2700 K, 3500 K, 4000 K, 5000 K, 6500 K)	
	Beam Angle	10° 15° 25° 30° 45° 65° 100° 10° × 30° 30° × 10° 10° × 60° 60° × 10° 15° × 45° 45° × 15° 15° × 90° 90° × 15° 30° × 60° 60° × 30° 30° × 90° 90° × 30° Asymmetrical Side Asymmetrical Forward	
	Lumen Output Delivered	1780 lm (@ 10°, RGBW)	
	Projected Lumen Maintenance	L90B10 >90.000 hrs, Ta = 25°C / 77°F	
	Control	Interface Protocol	DMX/RDM, DALI 2 or ON/OFF
	DALI 2 Device Type	DT 8	
	Control System	Third Party DMX Controllers	
	Operating Modes	DMX, Stand-alone	
	Settings / Addressing	E-Box, RDM communicator	
	Power Supply	Integrated	
Physical	Width × Height × Depth	189 × 196 × 119 mm (7.4 × 7.7 × 4.7 in.)	
	Weight	3.68 kg 8.11 lbs	
	Housing	High Pressure Die-Cast Aluminium Body Tempered Glass	
	Finish Options	Standard Colour – Graphite Black (RAL 9011) Silver (RAL 9006) Cost Option – Custom RAL Harsh Environment (RAL 9016, RAL 9011)	
	Cables / Connections	IN (for DMX, DALI, ON/OFF): – Cable with bare end – Cable length – custom – Junction box – optional	
	Mounting Method	Yoke	
	Adjustability	+180° / –180°	
	Protection Factor	IP67 (IP66 Junction Box) / Suitable For Wet Locations	
	IK Rating	IK10	
	Cooling System	Convection	
	Operating Ambient Temperature	–20 °C / +40 °C (–4 °F / +104 °F)	
	Certification	Listings	ETL / cETL, CE, RoHS, UKCA
	Accessories		Optical Demo Set for Calumma S
		Top Hat Calumma S	
		Half Top Hat Calumma S	
		Tenon Adaptor for Calumma S	
		Pole Mount Bracket for Calumma S	

Calumma™ MSC

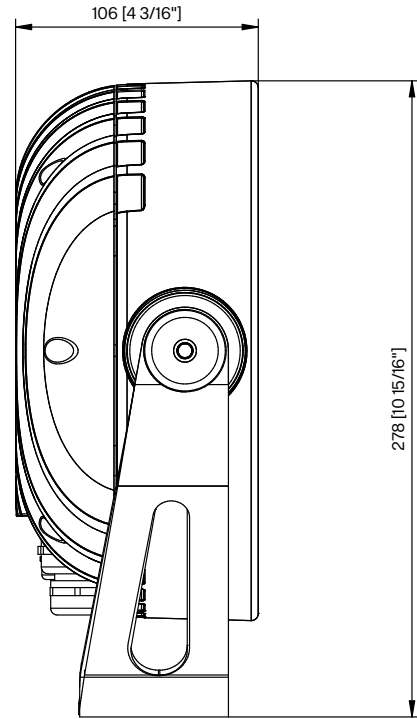
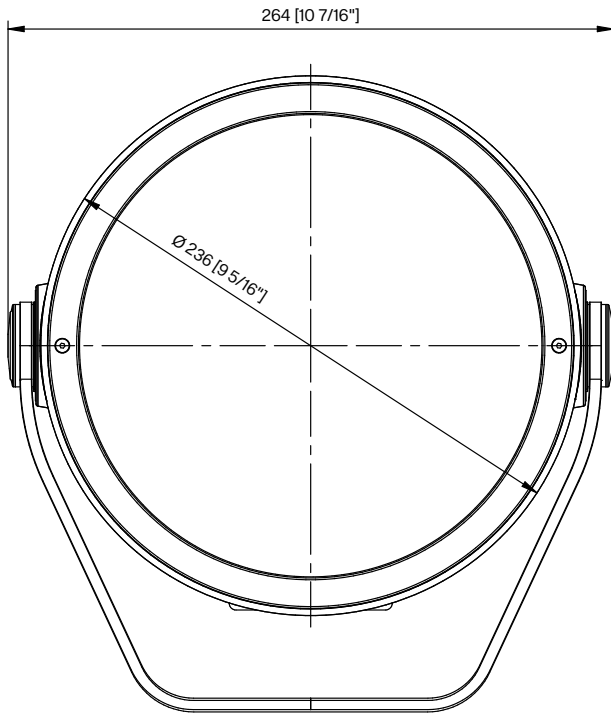

Luminous emittance 1 / Polar LDC

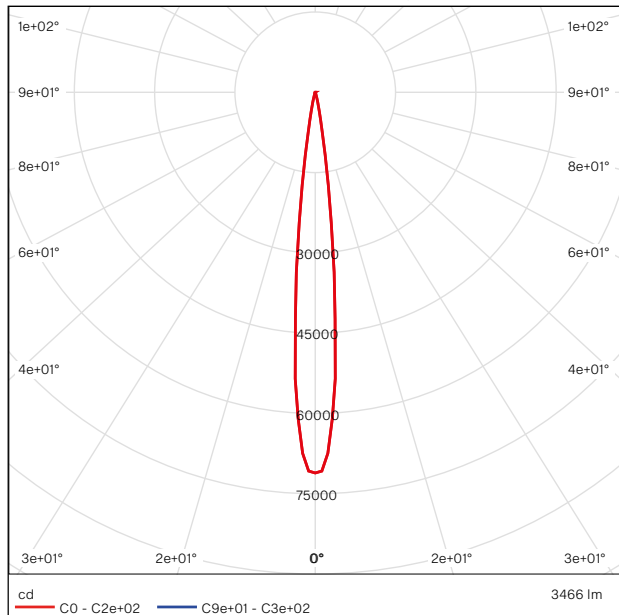

Luminous emittance 1 / Cone diagram

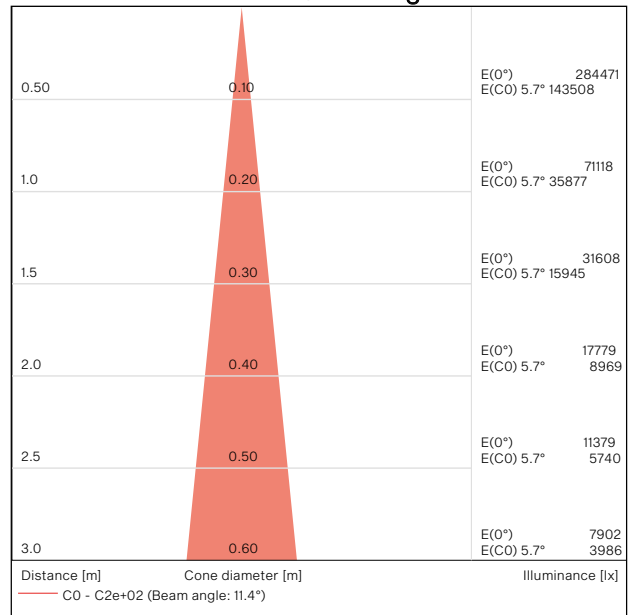

Electrical	Input Voltage	120–277 V AC 50/60 Hz (US)
	Typical Power Consumption	60 W ±10 %
Optical	Light Source	High Power Single Chip LEDs
	Colour Variants	RGBW (W – 6500 K) RGBA PW (W – 3000 K) Other Variants On Request (TW (2700–6500 K), 2200 K, 2500 K, 2700 K, 3500 K, 4000 K, 5000 K, 6500 K)
	Beam Angle	10° 15° 25° 30° 45° 65° 100° 10° × 30° 30° × 10° 10° × 60° 60° × 10° 15° × 45° 45° × 15° 15° × 90° 90° × 15° 30° × 60° 60° × 30° 30° × 90° 90° × 30° Asymmetrical Side Asymmetrical Forward
	Lumen Output Delivered	3466 lm (@10°, RGBW)
	Projected Lumen Maintenance	L90B10 >90.000 hrs, Ta = 25°C / 77°F
	Control	Interface Protocol
	E-Box control protocol	USITT DMX512 + RDM, ArtNet, MA Net, MA Net2, sACN, Kling-Net
	DALI 2 Device Type	DT 8
	Wireless DMX (Option)	Lumen Radio CRMX Technology
	Control System	Third Party DMX Controllers or third party DALI 2 controllers, Ethernet
	Operating Modes	DMX, Stand-alone
	Settings / Addressing	E-Box, RDM communicator
	Power Supply	Integrated
Physical	Width × Height × Depth	264 × 278 × 106 mm (10.4 × 10.94 × 4.17 in.)
	Weight	5.9 kg 13 lbs
	Housing	High Pressure Die-Cast Aluminium Body Tempered Glass
	Finish Options	Standard Colour – Graphite Black (RAL 9011) Silver (RAL 9006) Cost Option – Custom RAL Harsh Environment (RAL 9016, RAL 9011)
	Cables / Connections	IN/OUT (for E-Box version): – 0,5 m cables with hybrid connectors – Jumper cables IN (for DMX, DALI, ON/OFF): – Cable with bare end – Cable length – custom – Junction box – optional
	Mounting Method	Yoke
	Adjustability	+180° / -180°
	Protection Factor	IP67 (IP66 Junction Box) / Suitable For Wet Locations
	IK Rating	IK10
	Cooling System	Convection
	Operating Ambient Temperature	-20 °C / +40 °C (-4 °F / +104 °F)
Certification	Listings	ETL / cETL, CE, RoHS, UKCA
Accessories		Optical Demo Set for Calumma M
		Top Hat Calumma M
		Half Top Hat Calumma M
		Tenon Adaptor for Calumma M
		Pole Mount Bracket for Calumma M

Calumma™ L SC

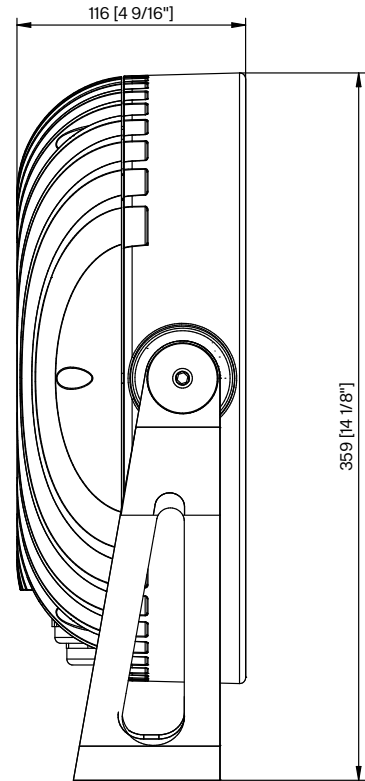
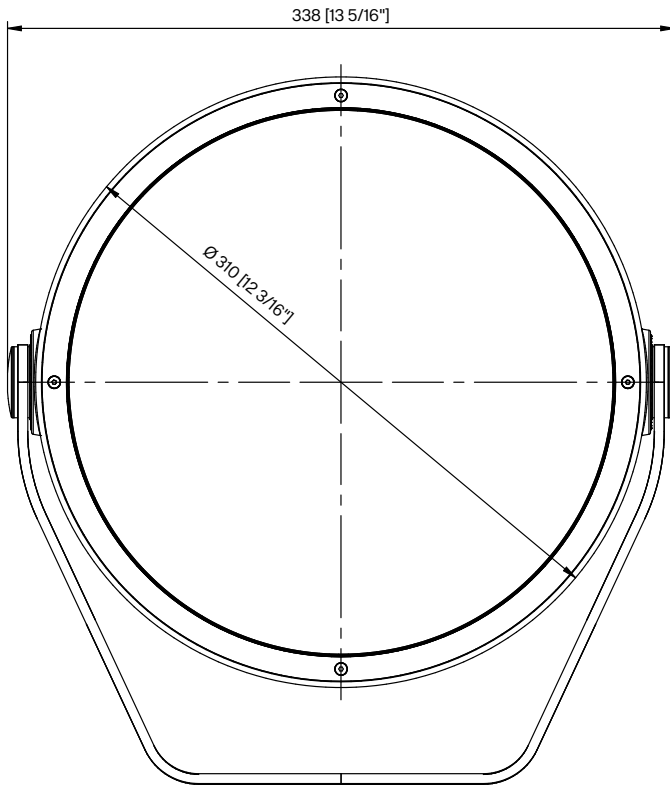

Luminous emittance 1 / Polar LDC

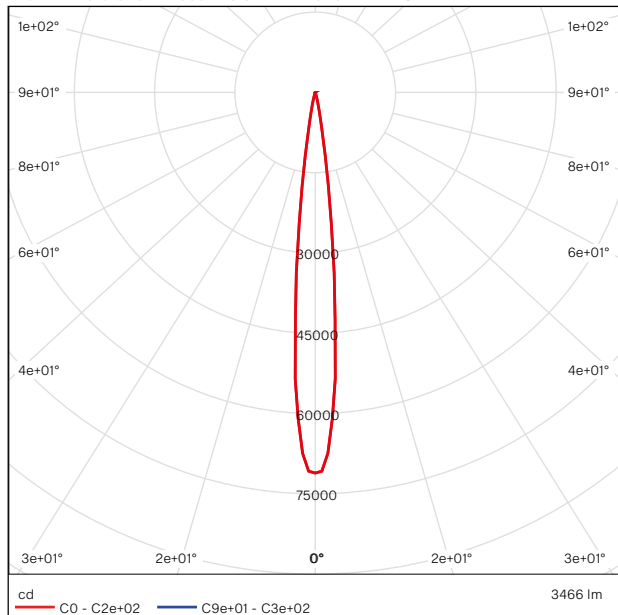

Luminous emittance 1 / Cone diagram

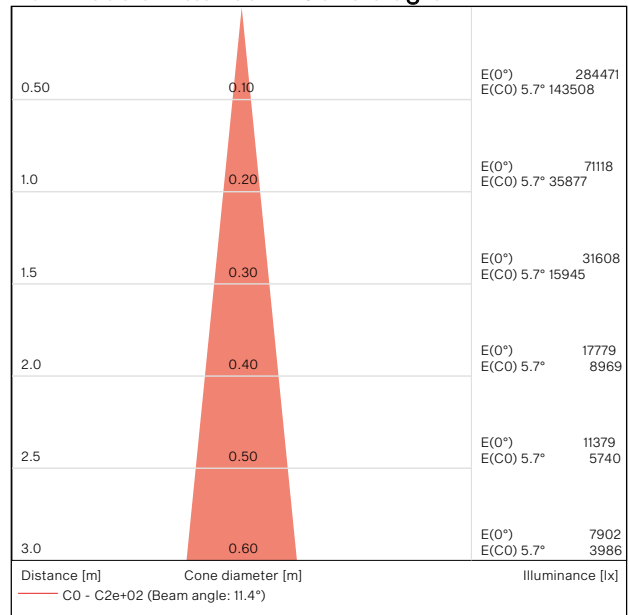

Electrical	Input Voltage	120–277 V AC 50/60 Hz (US)
	Typical Power Consumption	130 W ±10 %
Optical	Light Source	High Power Single Chip LEDs
	Colour Variants	RGBW (W – 6500 K) RGBA PW (W – 3000 K) Other Variants On Request (TW (2700–6500 K), 2200 K, 2500 K, 2700 K, 3500 K, 4000 K, 5000 K, 6500 K)
	Beam Angle	10° 15° 25° 30° 45° 65° 100° 10° × 30° 30° × 10° 10° × 60° 60° × 10° 15° × 45° 45° × 15° 15° × 90° 90° × 15° 30° × 60° 60° × 30° 30° × 90° 90° × 30° Asymmetrical Side Asymmetrical Forward
	Lumen Output Delivered	7962 lm (@ 10°, RGBW)
	Projected Lumen Maintenance	L90B10 >90.000 hrs, Ta = 25°C / 77°F
	Control	Interface Protocol
	E-Box control protocol	USITT DMX512 + RDM, ArtNet, MA Net, MA Net2, sACN, Kling-Net
	DALI 2 Device Type	DT 8
	Wireless DMX (Option)	Lumen Radio CRMX Technology
	Control System	Third Party DMX Controllers or third party DALI 2 controllers, Ethernet
	Operating Modes	DMX, Stand-alone
	Settings / Addressing	E-Box, RDM communicator
	Power Supply	Integrated
Physical	Width × Height × Depth	338 × 360 × 116 mm (13.31 × 14.13 × 4.57 in.)
	Weight	9.7 kg 21.38 lbs
	Housing	High Pressure Die-Cast Aluminium Body Tempered Glass
	Finish Options	Standard Colour – Graphite Black (RAL 9011) Silver (RAL 9006) Cost Option – Custom RAL Harsh Environment (RAL 9016, RAL 9011)
	Cables / Connections	IN/OUT (for E-Box version): – 0,5 m cables with hybrid connectors – Jumper cables IN (for DMX, DALI, ON/OFF): – Cable with bare end – Cable length – custom – Junction box – optional
	Mounting Method	Yoke
	Adjustability	+180° / -180°
	Protection Factor	IP67 (IP66 Junction Box) / Suitable For Wet Locations
	IK Rating	IK10
	Cooling System	Convection
	Operating Ambient Temperature	-20 °C / +40 °C (-4 °F / +104 °F)
Certification	Listings	ETL / cETL, CE, RoHS, UKCA
Accessories		Optical Demo Set for Calumma L
		Top Hat Calumma L
		Half Top Hat Calumma L
		Tenon Adaptor for Calumma L
		Pole Mount Bracket for Calumma L

Calumma™ XL SC

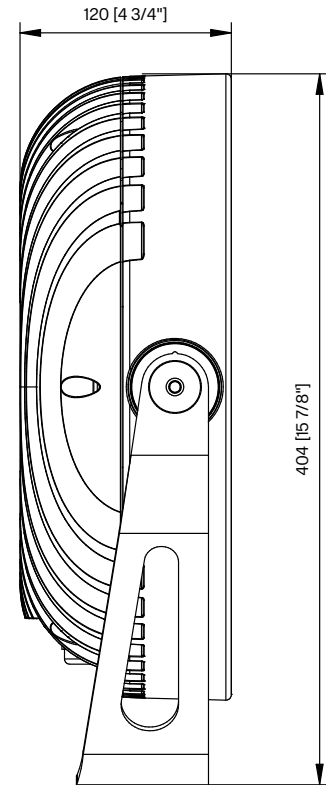
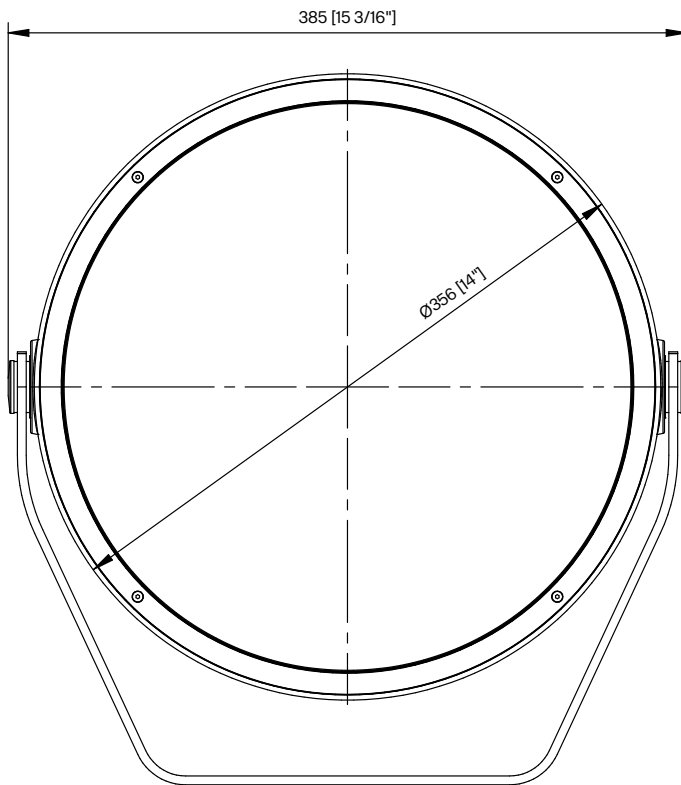

Luminous emittance 1 / Polar LDC

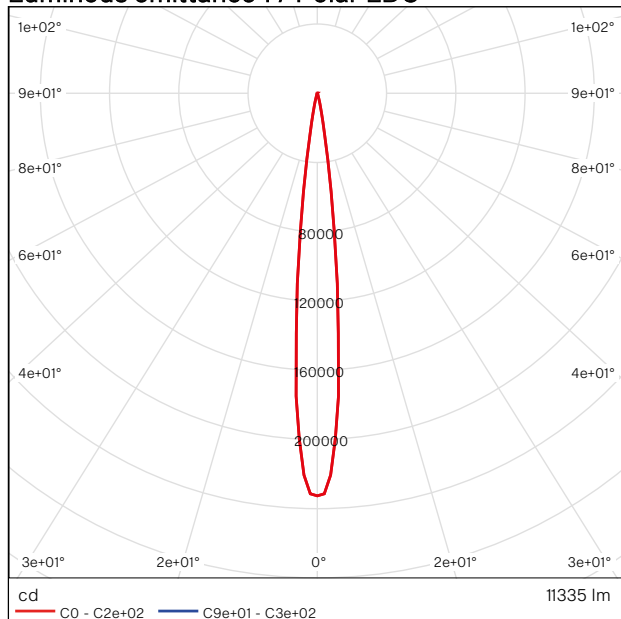

Luminous emittance 1 / Cone diagram

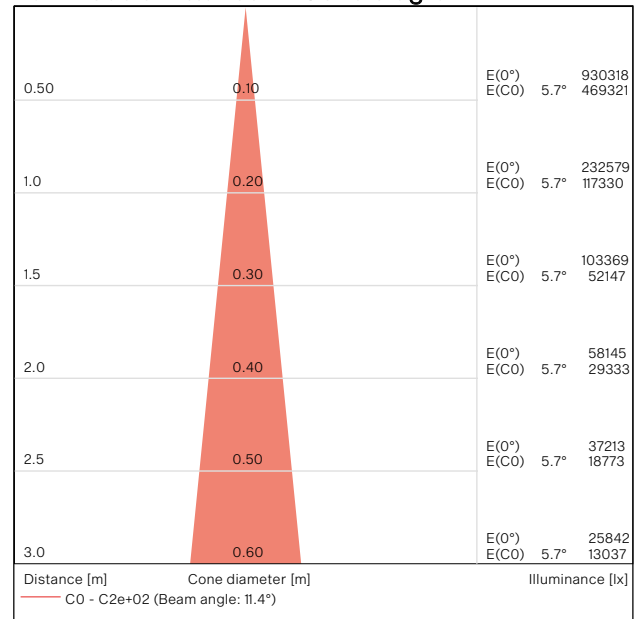

Electrical	Input Voltage	120–277 V AC 50/60 Hz (US)
	Typical Power Consumption	185 W ±10 %
Optical	Light Source	High Power Single Chip LEDs
	Colour Variants	RGBW (W – 6500 K) RGBA PW (W – 3000 K) Other Variants On Request (TW (2700–6500 K), 2200 K, 2500 K, 2700 K, 3500 K, 4000 K, 5000 K, 6500 K)
	Beam Angle	10° 15° 25° 30° 45° 65° 100° 10° × 30° 30° × 10° 10° × 60° 60° × 10° 15° × 45° 45° × 15° 15° × 90° 90° × 15° 30° × 60° 60° × 30° 30° × 90° 90° × 30° Asymmetrical Side Asymmetrical Forward
	Lumen Output Delivered	11335 lm (@10°, RGBW)
	Projected Lumen Maintenance	L90B10 >90.000 hrs, Ta = 25°C / 77°F
	Control	Interface Protocol
E-Box control protocol		USITT DMX512 + RDM, ArtNet, MA Net, MA Net2, sACN, Kling-Net
DALI 2 Device Type		DT 8
Wireless DMX (Option)		Lumen Radio CRMX Technology
Control System		Third Party DMX Controllers or third party DALI 2 controllers, Ethernet
Operating Modes		DMX, Stand-alone
Settings / Addressing		E-Box, RDM communicator
Power Supply		Integrated
Physical	Width × Height × Depth	385 × 404 × 120 mm (15.16 × 15.91 × 4.72 in.)
	Weight	12.7 kg 28 lbs
	Housing	High Pressure Die-Cast Aluminium Body Tempered Glass
	Finish Options	Standard Colour – Graphite Black (RAL 9011) Silver (RAL 9006) Cost Option – Custom RAL Harsh Environment (RAL 9016, RAL 9011)
	Cables / Connections	IN/OUT (for E-Box version): – 0,5 m cables with hybrid connectors – Jumper cables IN (for DMX, DALI, ON/OFF): – Cable with bare end – Cable length – custom – Junction box – optional
	Mounting Method	Yoke
	Adjustability	+180° / -180°
	Protection Factor	IP67 (IP66 Junction Box) / Suitable For Wet Locations
	IK Rating	IK10
	Cooling System	Convection
	Operating Ambient Temperature	-20 °C / +40 °C (-4 °F / +104 °F)
	Certification	Listings
Accessories		Optical Demo Set for Calumma XL
		Top Hat Calumma XL
		Half Top Hat Calumma XL
		Tenon Adaptor for Calumma XL
		Pole Mount Bracket for Calumma XL

Divine™ 160

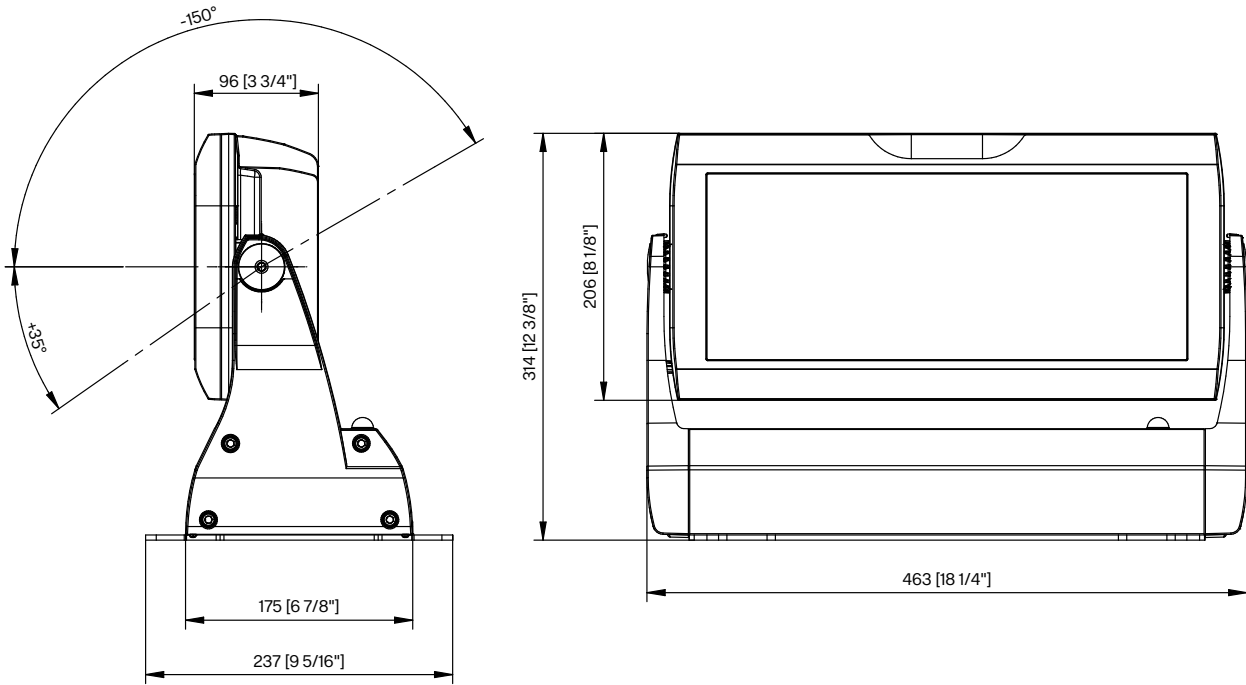

Luminous emittance 1 / Polar LDC

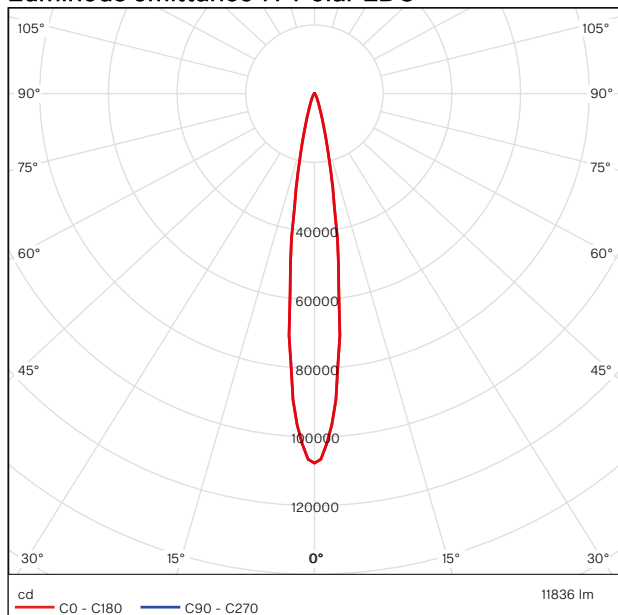

Luminous emittance 1 / Cone diagram

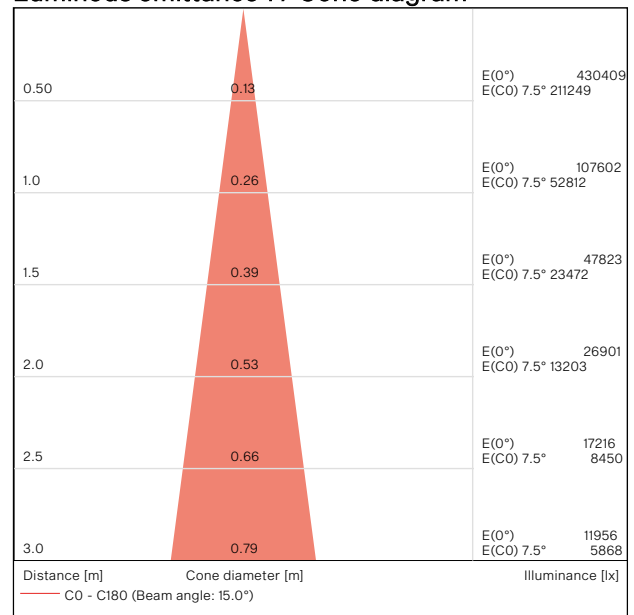

Electrical	Input Voltage	100–277 V AC 50/60 Hz
	Typical Power Consumption	440 W
	Inrush Current	30 A @ 230 V, 20 A @ 115 V
Optical	Light Source	40 × High Power Multi-chip LEDs
	Colour Variants	RGBW (W – 6500 K) RGBA PW (W – 3000 K) TW (2700–6500 K) Upon Request
	Beam Angle	Symmetrical: 13° 25° 35° 45° 65° 100° Bi-symmetrical: 15° × 35° 35° × 15° 15° × 65° 65° × 15° 20° × 45° 45° × 20° 35° × 70° 70° × 35° 35° × 90° 90° × 35° 20° × 90° 90° × 20°
	Lumen Output Delivered	11,836 lm (RGBW 13°, all LEDs on full)
	Projected Lumen Maintenance	L90B10 >90.000 hrs, Ta = 25°C / 77°F
Control	Display	LED Display (Inside Integrated Junction Box) Chassis Mounted LED Display (Optional)
	Wireless DMX (Option)	Lumen Radio CRMX Technology
	Interface Protocol	USITT DMX512, RDM, 0–10 V (PW only)
	Control System	Third Party DMX Controllers
	Operating Modes	DMX, Stand-alone
	DMX Modes	4 (for RGBW version)
	DMX Channels	10, 22, 5, 4
	Programs / Functions / Features	Editable Program: 1 (up to 40 steps)
	Settings / Addressing	Via LED Display with Control Buttons or RDM
	Power Supply	Integrated
Physical	Width × Height × Depth	463 × 314 × 175 / 237 mm (18.2 × 12.4 × 6.9 / 9.3 in.)
	Weight	13.4 kg / 29.54 lbs
	Housing	High Pressure Die-Cast Aluminium Body Tempered Glass
	Finish Options	Standard Colour – Graphite Black (RAL 9011), Silver (RAL 9006) Cost Option – Custom RAL
	Cables / Connections	Integrated Junction Box With Terminal Block Recommended: Li9Y11Y 3 × AWG16 + 1(2 × AWG24)
	Mounting Method	Surface Mount, Flush (J-Box), C-Clamp (For Side Connection Only)
	Adjustability	+35° / –150°
	Protection Factor	IP67 / Suitable For Wet Locations
	IK Rating	IK10
	Cooling System	Convection
	Operating Ambient Temperature	–20 °C / +40 °C (–4 °F / +104 °F)
	Operating Temperature	+75 °C @ Ambient +40 °C (+167 °F @ Ambient +104 °F)
	Total Heat Dissipation	1500 BTU/h (calculated)
	Certification	Listings
Accessories		Surface Mount Adaptor (Included)
		Optical Demo Set for Divine 160
		Top Hat Divine 160
		Half Top Hat Divine 160
		Barn Door Module Divine 160
		Wire Guard/Anti-Glare Divine 160
		Set of Rubber Feet
		C-Clamp Adaptor Divine (for side conn. only) Single Top Loader Case Divine

Divine™ 72

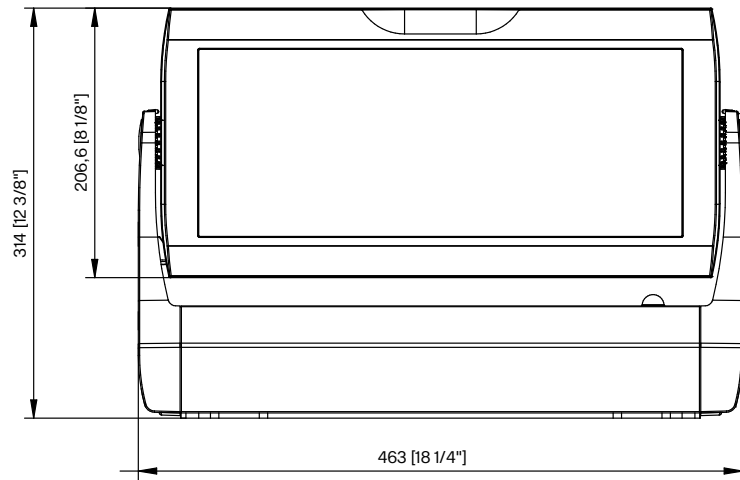
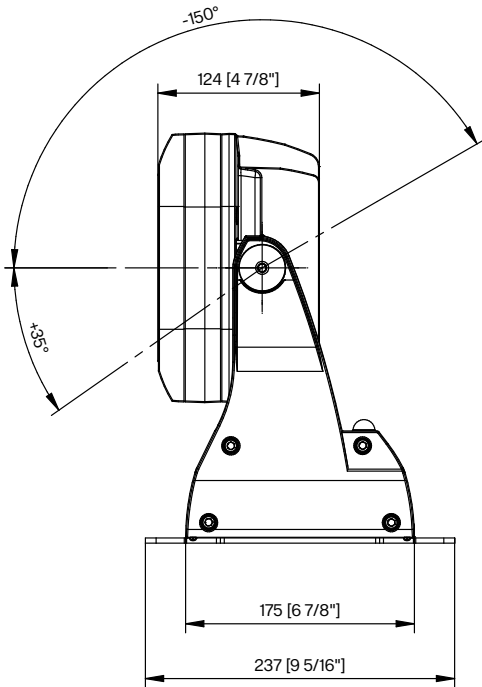

Luminous emittance 1 / Polar LDC

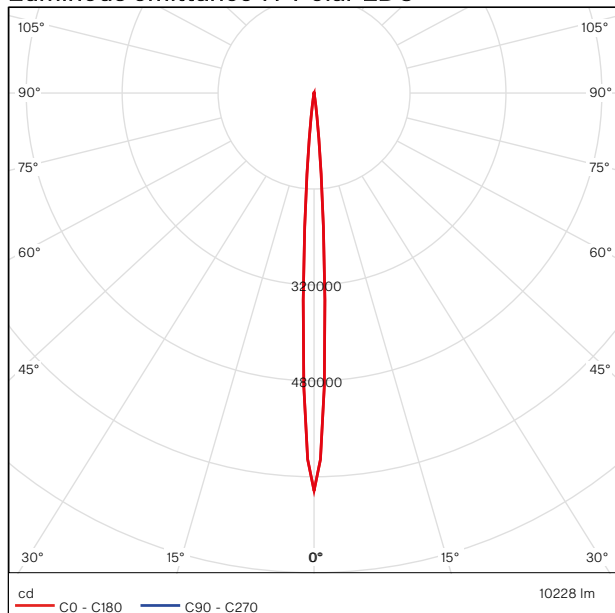

Luminous emittance 1 / Cone diagram

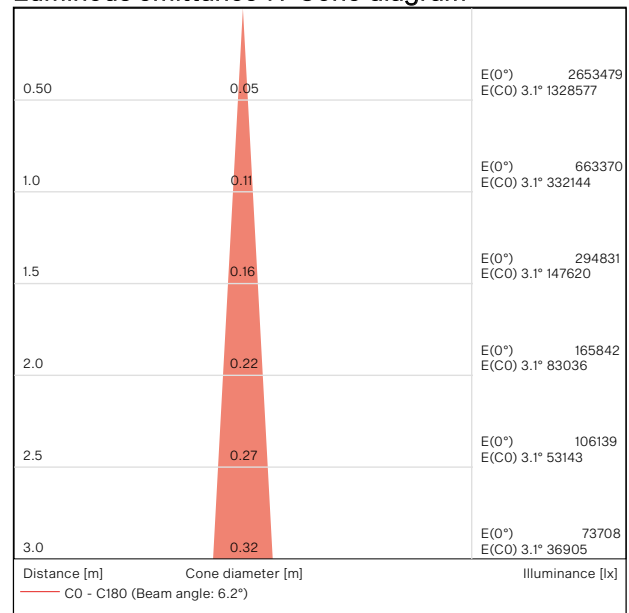

Electrical	Input Voltage	100–277 V AC 50/60 Hz
	Typical Power Consumption	325 W ±10 %
	Inrush Current	30 A @ 230 V, 20 A @ 115 V
Optical	Light Source	72 × High Power Single Chip LEDs
	Colour Variants	RGBW (W – 6500 K) RGBA PW (6500 K) Upon Request
	Beam Angle	Symmetrical: 6° 10° 20° 30° 45° 60° 100° Bi-symmetrical: 6° × 30° 30° × 6° 6° × 60° 60° × 6° 10° × 40° 40° × 10° 35° × 70° 70° × 35° 30° × 90° 90° × 30° 10° × 90° 90° × 10°
	CRI	70 + (@RGBCW and PW 6500 K)
	Peak Intensity	6573 lx @ 10 m
	Lumen Output Delivered	10,228 lm (RGBW 6°, all LEDs on full)
	Projected Lumen Maintenance	L90B10 >90,000 hrs, Ta = 25°C / 77°F
	Control	Display
Wireless DMX (Option)		Lumen Radio CRMX Technology
Interface Protocol		USITT DMX512, RDM, 0–10 V (PW only)
Control System		Third Party DMX Controllers
Operating Modes		DMX, Stand-alone
DMX Modes		4 (for RGBW version)
DMX Channels		10, 14, 5, 4
Programs / Functions / Features		Editable Program: 1 (up to 40 steps)
Settings / Addressing		Via LED Display with Control Buttons or RDM
Power Supply		Integrated
Physical	Width × Height × Depth	463 × 314 × 175 / 237 mm (18.2 × 12.4 × 6.9 / 9.3 in.)
	Weight	16.5 kg / 36.38 lbs
	Housing	High Pressure Die-Cast Aluminium Body Tempered Glass
	Finish Options	Standard Colour – Graphite Black (RAL 9011), Silver (RAL 9006) Cost Option – Custom RAL
	Cables / Connections	Integrated Junction Box With Terminal Block Recommended: Li9Y11Y 3 × AWG16 + 1(2 × AWG24)
	Mounting Method	Surface Mount, Flush (J-Box), C-Clamp (For Side Connection Only)
	Adjustability	+35° / –150°
	Protection Factor	IP67 / Suitable For Wet Locations
	IK Rating	IK10
	Cooling System	Convection
	Operating Ambient Temperature	–20 °C / +40 °C (–4 °F / +104 °F)
	Operating Temperature	+85 °C @ Ambient +25 °C (+185 °F @ Ambient +77 °F)
	Total Heat Dissipation	1410 BTU/h (calculated)
Certification	Listings	ETL / cETL, CE, RoHS, UKCA
Accessories		Surface Mount Adaptor (Included)
		Optical Demo Set for Divine 72
		Set of Rubber Feet
		Barndoor module
		C-Clamp Adaptor Divine (for side conn. only) Single Top Loader Case Divine

Divine™ 60 UV

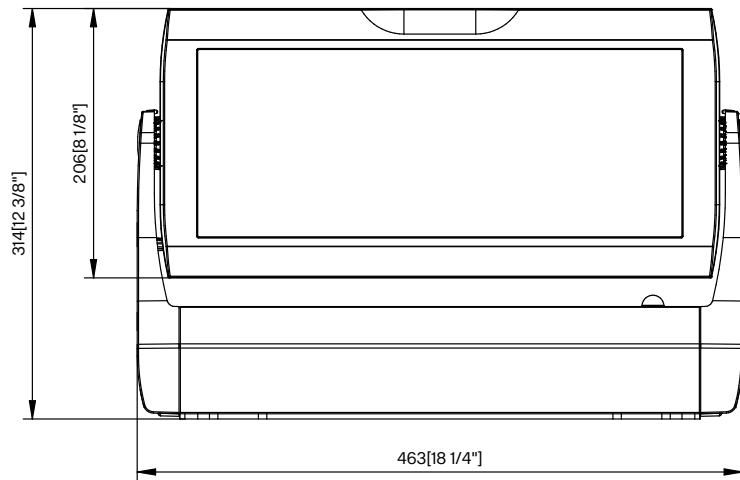
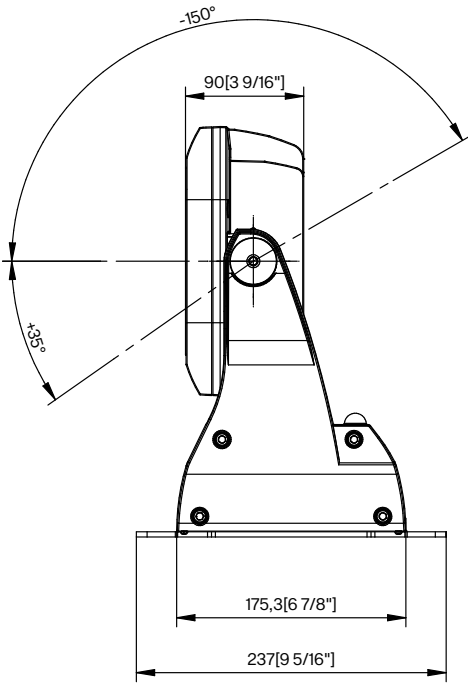

Electrical	Input Voltage	100–277 V AC 50/60 Hz	
	Typical Power Consumption	180 W ±10 %	
	Inrush Current	30 A @ 230 V, 20 A @ 115 V	
Optical	Light Source	60 × UV LEDs	
	Wave Length	365 nm (peak)	
	Beam Angle	38°	
	Projected Lumen Maintenance	16,000 hrs (L70 @ 77 °F / 25 °C)	
Control	Display	LED Display (Inside Integrated Junction Box) Chassis Mounted LED Display (Optional)	
	Wireless DMX (Option)	Lumen Radio CRMX Technology	
	Interface Protocol	USITT DMX512, RDM, 0–10 V	
	Control System	Third Party DMX Controllers	
	Operating Modes	DMX, Stand-alone	
	DMX Modes	3	
	DMX Channels	2, 3, 9	
	Programs / Functions / Features	Editable Program: 1 (up to 40 steps)	
	Settings / Addressing	Via LED Display with Control Buttons or RDM	
	Power Supply	Integrated	
	Physical	Width × Height × Depth	463 × 314 × 175 / 237 mm (18.2 × 12.4 × 6.9 / 9.3 in.)
		Weight	14.5 kg / 32 lbs
Housing		High Pressure Die-Cast Aluminium Body Tempered Glass	
Finish Options		Standard Colour – Graphite Black (RAL 9011), Silver (RAL 9006) Cost Option – Custom RAL	
Cables / Connections		Integrated Junction Box With Terminal Block Recommended: Li9Y11Y 3 × AWG16 + 1(2 × AWG24)	
Mounting Method		Surface Mount, Flush (J-Box), C-Clamp (For Side Connection Only)	
Adjustability		+35° / –150°	
Protection Factor		IP67 / Suitable For Wet Locations	
IK Rating		IK10	
Cooling System		Convection	
Operating Ambient Temperature		–20 °C / +40 °C (–4 °F / +104 °F)	
Operating Temperature		+70 °C @ Ambient +40 °C (+158 °F @ Ambient +104 °F)	
Total Heat Dissipation		680 BTU/h (calculated)	
Certification		Listings	ETL / cETL, CE, RoHS, UKCA
Accessories			Surface Mount Adaptor (Included)
		Top Hat Divine 60 UV	
		Half Top Hat Divine 60 UV	
		Wire Guard/Anti-Glare Divine 60 UV	
		Adaptor w/ Black Glass for Divine 60 UV	
		Set of Rubber Feet	
		C-Clamp Adaptor Divine (for side conn. only) Single Top Loader Case Divine	

ArcSource™ Inground 24MC Integral

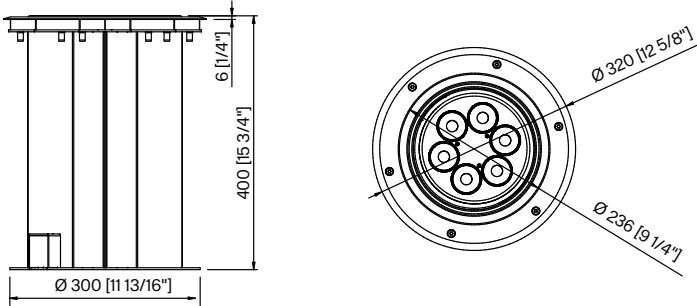

ArcSource Inground 24MC Integral RGBCW ANTI SKID

Luminous emittance 1 / Polar LDC

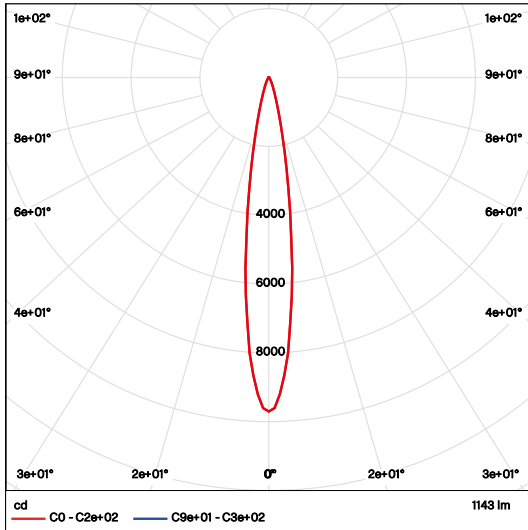

Luminous emittance 1 / Cone diagram

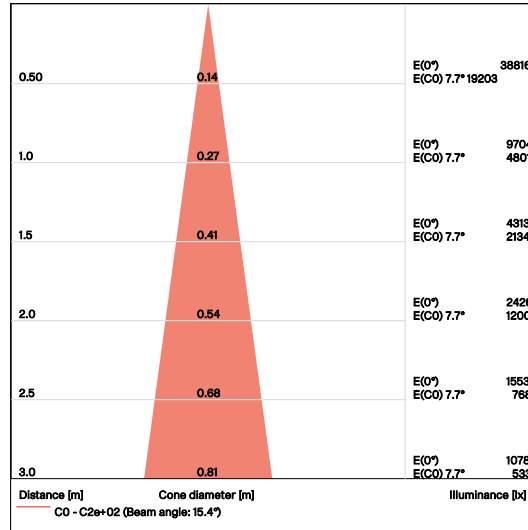

ArcSource Inground 24MC Integral RGBCW

Luminous emittance 1 / Polar LDC

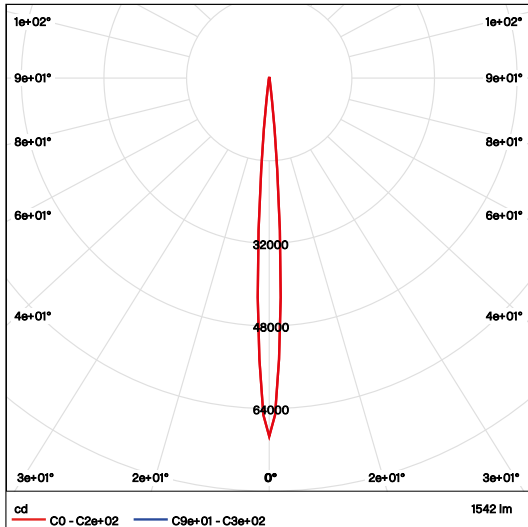

Luminous emittance 1 / Cone diagram

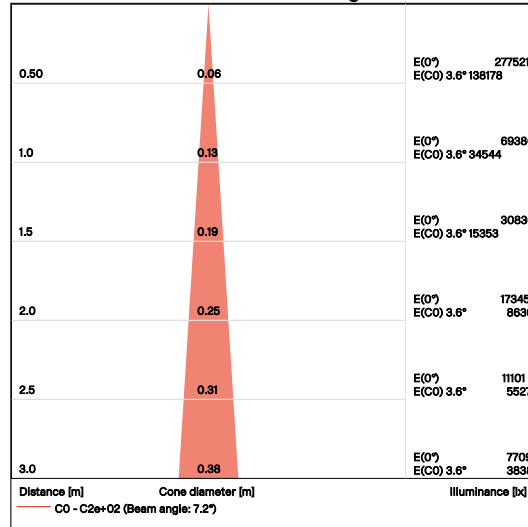

Electrical	Input Voltage	100–277 V AC 50/60 Hz			
	Typical Power Consumption	65 W @ 230 V			
Optical	Light Source	6 × 15 W Multi-chip LEDs			
	Colour Variants	RGBW (W – 6500 K), RGBA, PW (W – 3000 K)			
	Beam Angle	Clear Glass	Symmetrical: 7° 24° 34°	Bi-symmetrical: 7° × 42° 42° × 7°	
		Anti-Skid Glass	Symmetrical: 16° 28° 33°	Bi-symmetrical: 16° × 42° 42° × 16°	
	Lumen Output Delivered	Clear Glass	1542 lm	RGBW 7° W – 6500 K, all LEDs on full	
		Anti-Skid Glass	1297 lm	RGBW 16 × 42° W – 6500 K, all LEDs on full	
	Projected Lumen Maintenance	L90B10 >90.000 hrs, Ta = 25°C / 77°F			
Control	Wireless DMX (Option)	Lumen Radio CRMX Technology			
	Interface Protocol	USITT DMX 512, RDM			
	Control System	ArcControl range or any Third Party DMX Controllers			
	Operating Modes	DMX, Master/Slave, Stand-alone			
	Programs / Functions / Features	Editable Program: 3 (up to 40 steps each)			
	Settings / Addressing	Via RDM communicator or ROBE Universal Interface (RUNIT)			
	Power Supply	Integrated			
Physical	Width × Height × Depth	Ø320 × 400 mm (Ø12.6 × 15.75 in.)			
	Weight	18.2 kg 40.1 lbs	9 kg 19.8 lbs ArcSource Inground	9.2 kg 20.3 lbs Sleeve	
	Housing	High Pressure Die-Cast Aluminium Body – Stainless Steel Flange			
		Tempered Glass			
	Cables / Connections	Integral Junction Box			
	Mounting Method	External Sleeve			
	Adjustability	Motorized Tilt ±15°			
	Protection Factor	IP68 (1 m / 3.28 ft / 8 hrs) / Suitable For Wet Locations			
	IK Rating	IK10			
	Static Load Resistance	35 kN (surface Ø10 cm load)			
	Cooling System	Convection			
	Operating Ambient Temperature	–20 °C / +40 °C (–4 °F / +104 °F)			
	Operating Temperature	+55 °C @ Ambient +40 °C (+131 °F @ Ambient +104 °F)			
	Certification	Listings	ETL / cETL, CE, RoHS, UKCA		
Anti – Skid Glass Certification		UNE ENV12633 (Class 3), DIN 51130 (R-12), DIN 51097 (Class B), ASTM C 1028-07 (DRY: ≥ 0,7, WET: ≥ 0,6), EN101:91 MOHS (4-Point scale)			

ArcSource™ Submersible II

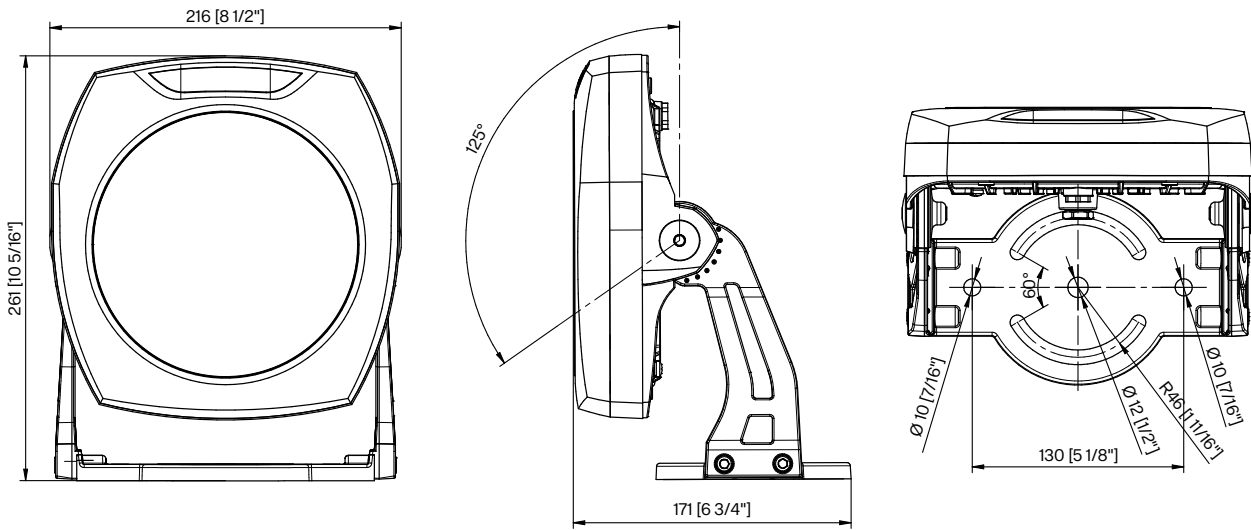

Luminous emittance 1 / Polar LDC

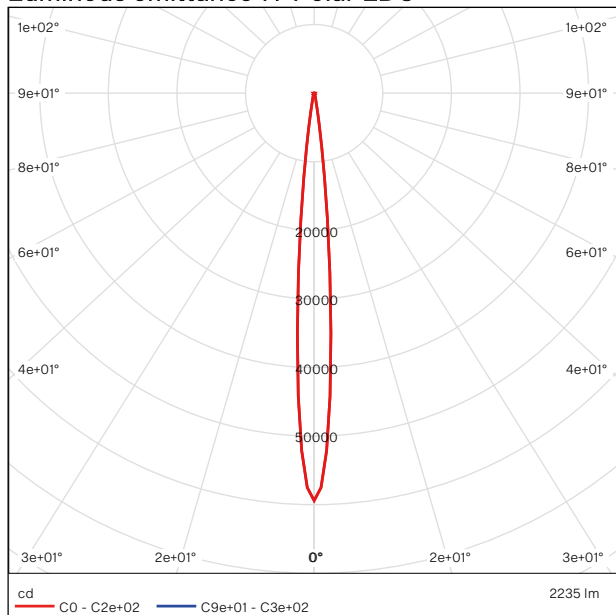

Luminous emittance 1 / Cone diagram

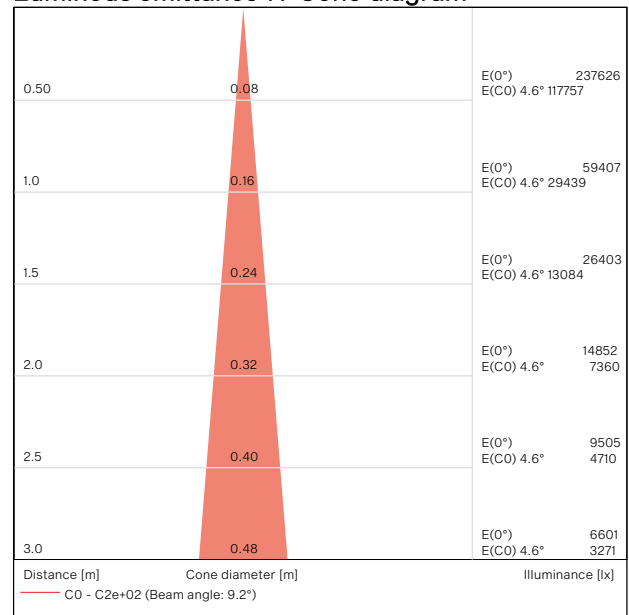

Electrical	Typical Power Consumption	35 W (@ 350 mA), 75 W (@ 700 mA), 100 W (@ 1000 mA)			
	Max. Input Current	1000 mA (max. per channel)			
Optical	Light Source	6 × 15 W Multi-chip LED			
	Colour Variants	RGBW (W – 6500 K) RGBA PW (W – 3000 K)			
	Beam Angle	Symmetrical: 7° 13° 20° 30° 40° 60° 90°			
		Bi-symmetrical: 7° × 30° 30° × 7° 7° × 60° 60° × 7° 35° × 70° 70° × 35° 10° × 90° 90° × 10°			
	Lumen Output Delivered	2235 lm	RGBCW 7° W – 6500 K, all LEDs on full, 1000 mA	submersed	
		1462 lm	RGBA 7° all LEDs on full, 1000 mA	submersed	
		1652 lm	PW 7° W – 3000 K, all LEDs on full, 1000 mA	submersed	
Projected Lumen Maintenance	L90B10 >90.000 hrs, Ta = 25°C / 77°F				
Control	Display	No Display			
	Power Supply	SubDrive 1 SubDrive 4			
Physical	Width × Height × Length	216 × 261 × 171 mm (8.5 × 10.28 × 6.73 in.)			
	Weight	7.42 kg / 16.36 lbs			
	Housing	Marine Bronze			
		Tempered Glass			
	Cables / Connections	Cable Submersible PBS-USE 3 × 1.5 mm ² (CE) Cable Submersible L0390 (US)			
	Mounting Method	Yoke, Floor Stand (optional)			
	Adjustability	+35° / -90°			
	Protection Factor	IP68 10m rating (CE) Maximum depth of 10 m (US)			
	IK Rating	IK10			
	Cooling System	Convection			
	Operating Ambient Temperature	+1 °C / +45 °C (+34 °F / +113 °F)			
	Operating Temperature	+55 °C @ Ambient +45 °C (+131 °F @ Ambient +113 °F)			
	Certification	Listings	ETL / cETL, CE, RoHS, UKCA		
Accessories	Power Supply	SubDrive 1			
		SubDrive 4			
	Mounting	Wallmount Installation Sleeve			
Floor Stand ArcSource Submersible II					

ArcPar™ 150 Outdoor

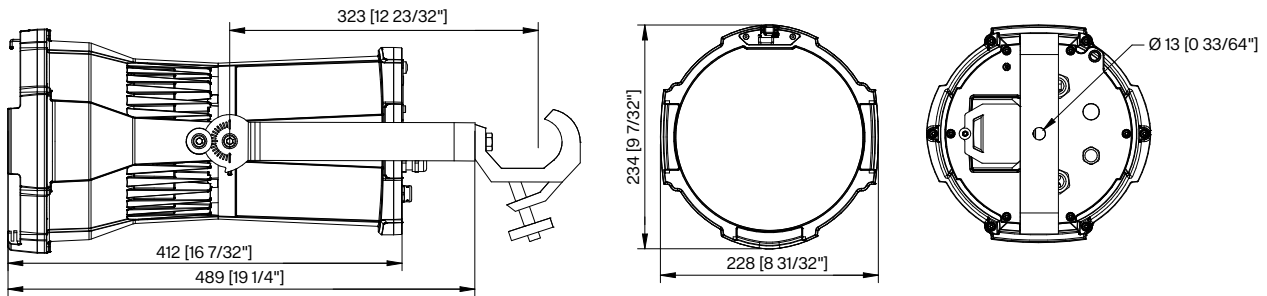

ArcPar 150 Outdoor RGBCW Zoom 0

Luminous emittance 1 / Polar LDC

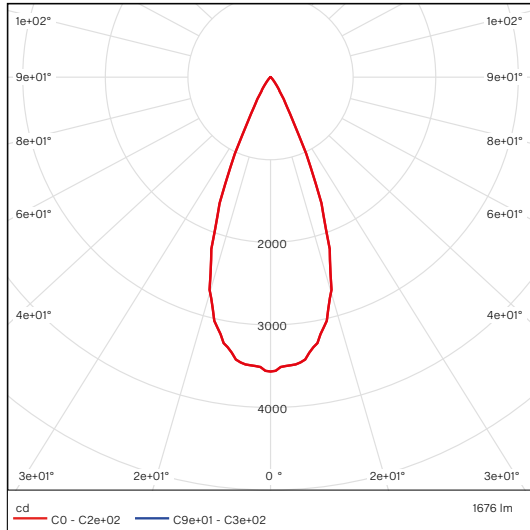

Luminous emittance 1 / Cone diagram

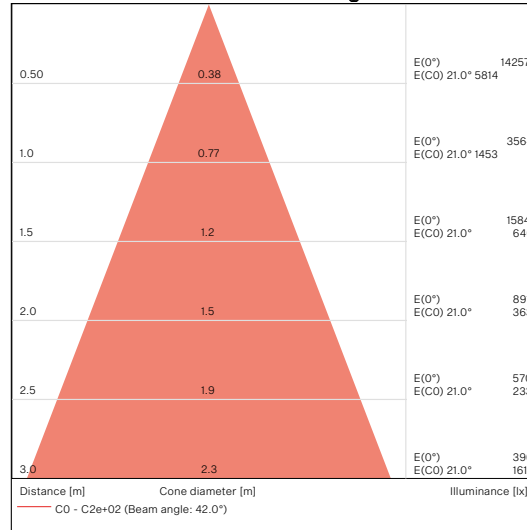

ArcPar 150 Outdoor RGBCW Zoom 255

Luminous emittance 1 / Polar LDC

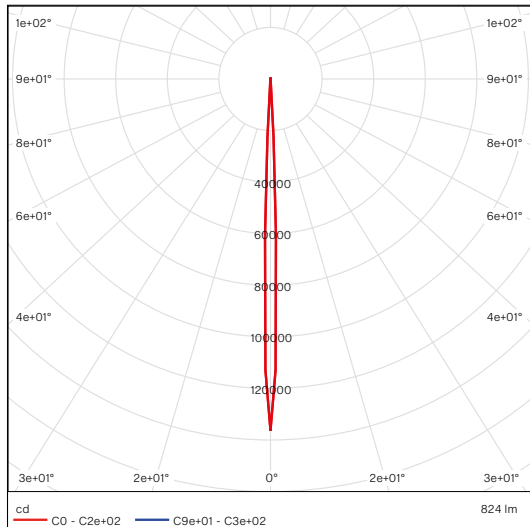

Luminous emittance 1 / Cone diagram

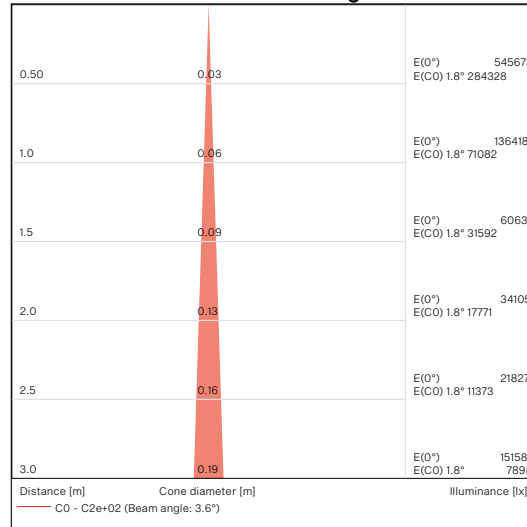

Electrical	Input Voltage	100–240 V AC 50/60 Hz (CE) 100–277 V AC 50/60 Hz (US)
	Typical Power Consumption	220 W ±10 %
Optical	Light Source	7 × 40 W High Power Multi-chip LEDs
	Colour Variants	RGBW (W – 6500 K) RGBA
	Beam Angle	Zoom Range 3.8° – 60°
	Lumen Output Delivered	1676 lm (RGBW @ 40°)
	Projected Lumen Maintenance	L90B10 >90.000 hrs, Ta = 25°C / 77°F
Control	Display	2-Row LCD Display With Control Buttons
	Wireless DMX (Option)	Lumen Radio CRMX Technology
	Interface Protocol	USITT DMX512, RDM
	Control System	Third Party DMX Controllers
	Operating Modes	DMX, Stand-alone
	DMX Modes	3
	DMX Channels	17, 11, 5
	Programs / Functions / Features	Virtual Colour Wheel with 66 Preset Swatches Tungsten Dim Effect at Whites of 2700 K and 3000 K (Red Shift) 18-bit Driving of LEDs (Super Smooth Colour Mixing And Dimming)
	Settings / Addressing	Via LCD Display with Control Buttons or RDM
	Power Supply	Integrated, Auto-Ranging
Physical	Width × Height × Depth	228 × 234 × 412 mm (8.97 × 9.21 × 16.22 in.)
	Weight	7.92 kg 17.46 lbs
	Housing	High Pressure Die-Cast Aluminium Body Tempered Glass
	Finish Options	Standard Colour – Graphite Black (RAL 9011) Silver (RAL 9006) Cost Option – Custom RAL
	Cables / Connections	Power Cable 1.2 m Bare End, DMX Cable IN / OUT 1 m With IP67 XLR – 5 pin
	Mounting Method	Yoke
	Adjustability	360°
	Protection Factor	IP65 / Suitable For Wet Locations
	IK Rating	IK06
	Cooling System	Convection
	Max. Ambient Temperature	+40 °C (104 °F)
	Max. Surface Temperature	+80 °C (+176 °F)
	Certification	Listings
Accessories		Top Hat ArcPar 150 Outdoor
		Half Top Hat ArcPar 150 Outdoor
		Barn Door
		Doughty Trigger Clamp
		Safety wire 36 kg

ArcDot™

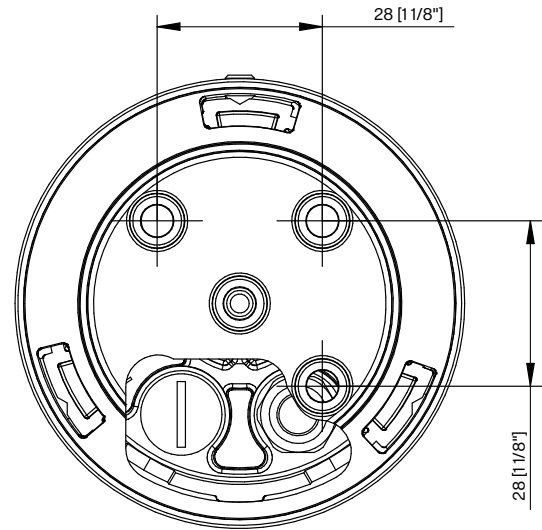
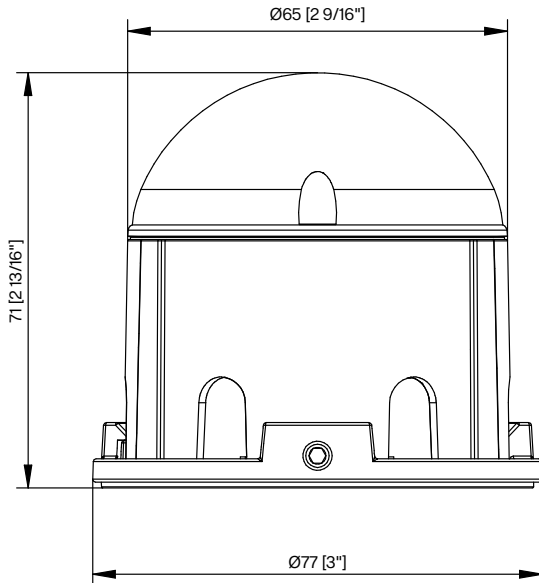

Luminous emittance 1 / Polar LDC

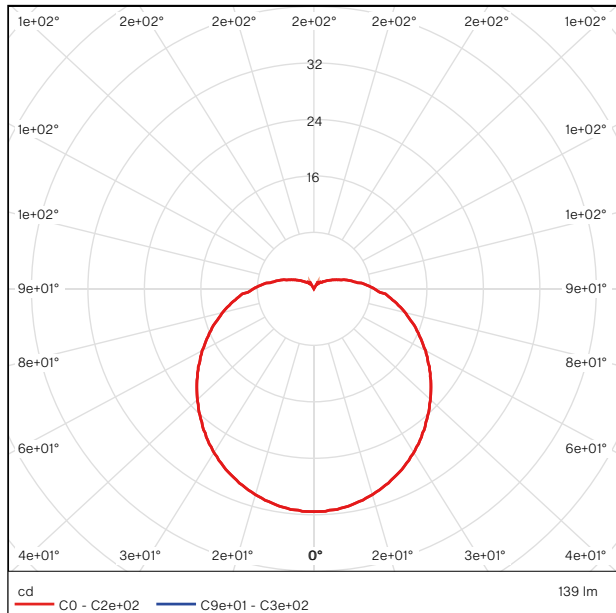

Luminous emittance 1 / Cone diagram

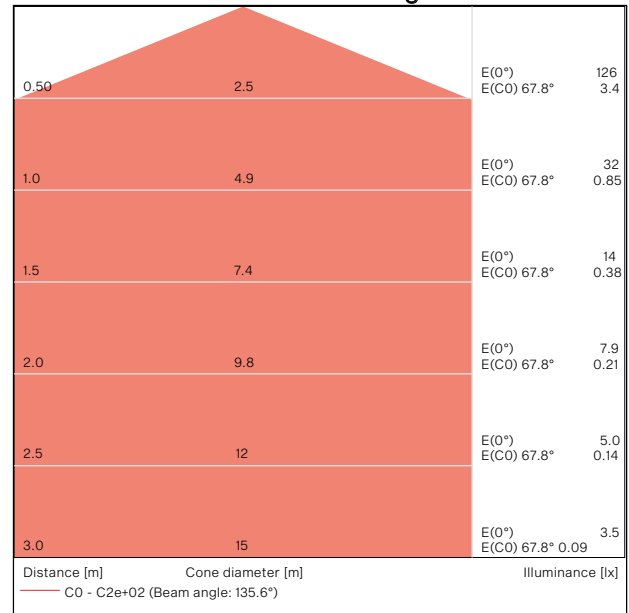

Electrical	Input Voltage	48 V
	Typical Power Consumption	5.5 W / 48 V
Optical	Light Source	1 × 15 W Multi-chip LEDs
	Colour Variants	RGBW (W – 6500 K) RGBA PW (W – 3000 K)
	Beam Angle	non-optic
	Lumen Output Delivered	139 lm (RGBW 7° W – 6500 K, all LEDs on full, 700 mA)
	Projected Lumen Maintenance	L90B10 >90.000 hrs, Ta = 25°C / 77°F
Control	Control System	ArcPixel Power, ArcPower Unit Pixel
	Power Supply	ArcPixel Power, ArcPower Unit Pixel
Physical	Width × Height	Ø77 × 71 mm Ø3.03 × 2.80 in.
	Weight	0.2 kg 0.44 lbs
	Finish Options	Standard Colour – Graphite Black (RAL 9011) Silver (RAL 9006)
		Cost Option – Custom RAL
	Housing	Cast Aluminium
		Polycarbonate Dome
	Cables / Connections	Li9Y11Y, 2 × AWG16 + 1 × AWG20, Chogori IP67 connector
	Mounting Method	Mounting Back Plate
	Protection Factor	IP67 / Suitable For Wet Locations
	IK Rating	IK10
	Cooling System	Convection
	Operating Ambient Temperature	-20 °C / +50 °C (-4 °F / +122 °F)
	Operating Temperature	+35 °C @ Ambient +25 °C (+95 °F @ Ambient +77 °F)
Certification	Listings	ETL / cETL, CE, RoHS, UKCA
Accessories		Cable Connection ArcDot 1 5 10 m
		Connector T- CGRBA (3-pin)
		Connector CGRBB-03BMMA-SL8001 (Male)
		Connector CGRBB-03BFFA-SL8001 (Female)
		Terminator Active for Arc Dot / ArcSource Outdoor 4MC Pixel
		Terminator Passive for Arc Dot / ArcSource Outdoor 4MC Pixel
		Cable, w/out connectors (1 m)
		Ferrite GTFC 16-8-16

ArcPix™ II

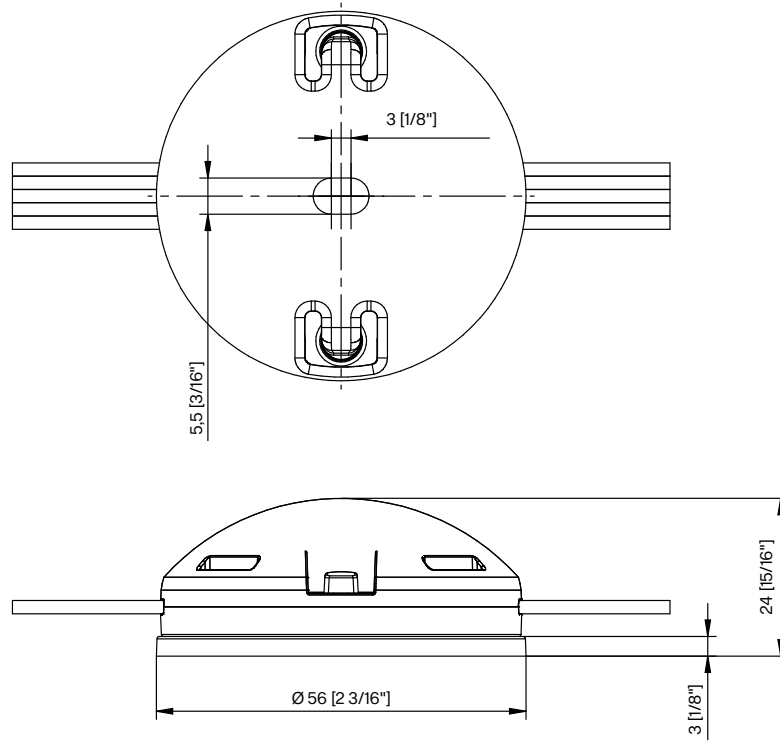

Luminous emittance 1 / Polar LDC

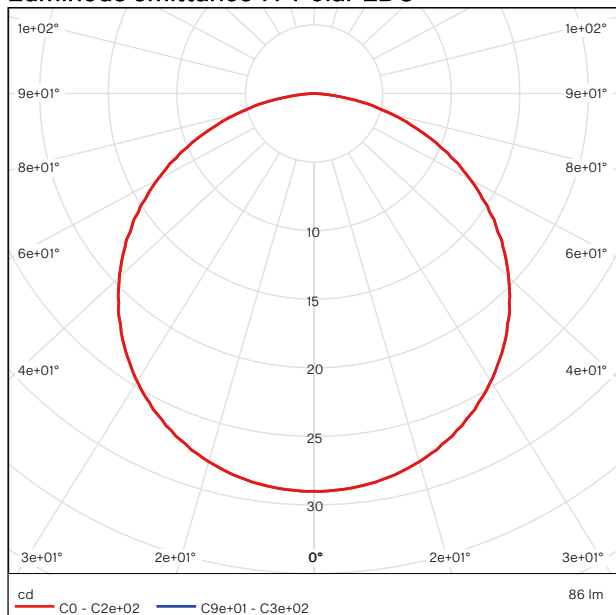

Luminous emittance 1 / Cone diagram

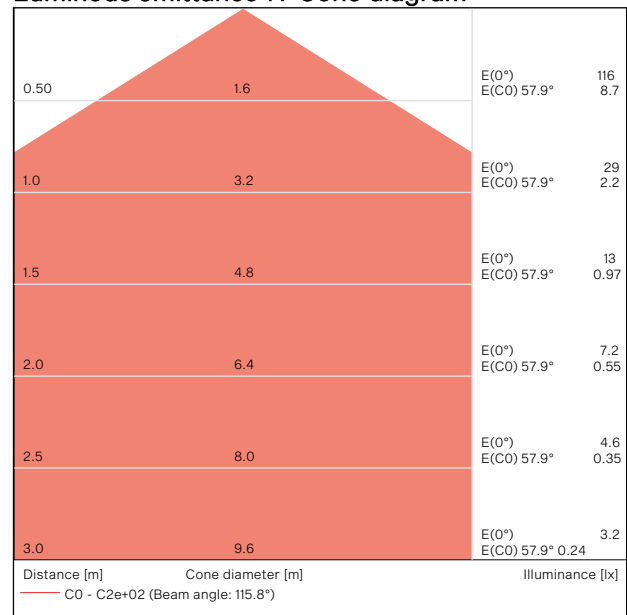

Electrical	Input Voltage	48 V
	Typical Power Consumption	0.8 W / 48 V
Optical	Light Source	1 × MC Mid Power LED
	Colour Variants	RGBCW (W – 6500 K)
	Beam Angle	non-optic
	Lumen Output Delivered	86 lm (RGBW, W – 6500 K, all LEDs on full)
	Projected Lumen Maintenance	L90B10 >90.000 hrs, Ta = 25°C / 77°F
Control	Control System	ArcPixel Power, ArcPower Unit Pixel
	Power Supply	ArcPixel Power, ArcPower Unit Pixel
Physical	Width × Height	Ø56 × 24 (Ø2.21 × 0.95 in.)
	Weight	0.1 kg / 0.22 lbs
	Housing	Moulded Plastic
		Polycarbonate Cover
	Cables / Connections	5 Wire Flat Cable AWM 295720AWG – Factory Fitted Connector
	Mounting Method	Mounting Plate or Direct Fitting
	Protection Factor	IP67 / Suitable For Wet Locations
	IK Rating	IK09
	Cooling System	Convection
	Operating Ambient Temperature	-20 °C / +50 °C (-4 °F / +122 °F)
	Operating Temperature	+50 °C @ Ambient +40 °C (+122 °F @ Ambient +104 °F)
Certification	Listings	ETL / cETL, CE, RoHS, UKCA
Accessories		Connection Cable
		Connection Box
		Termination Box (1 per run)

Ambiane™

XP56 Recessed

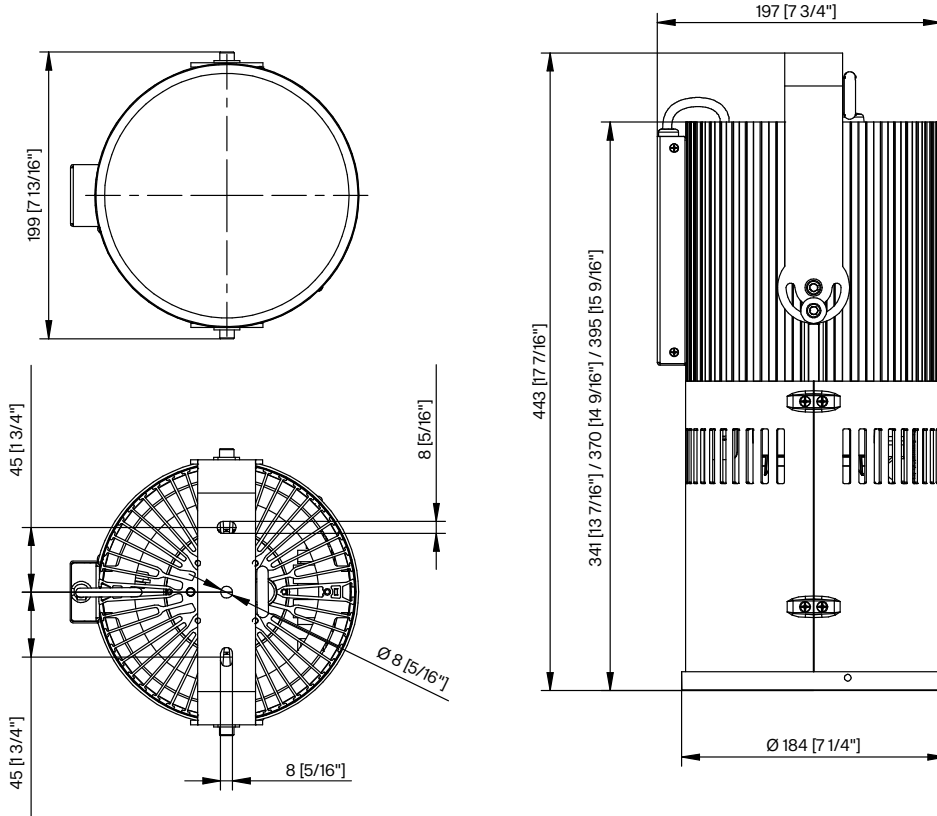

Luminous emittance 1 / Polar LDC

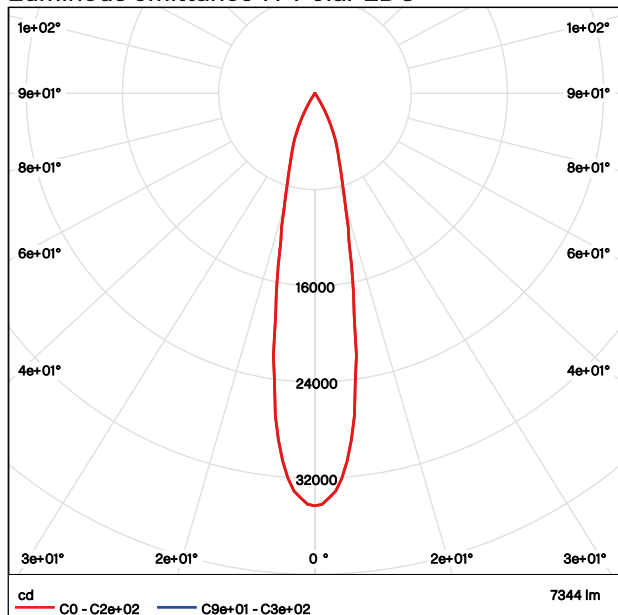

Luminous emittance 1 / Cone diagram

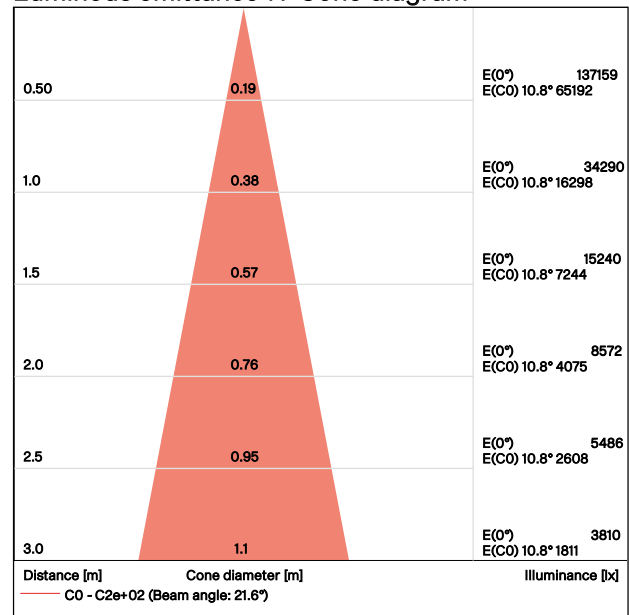

Electrical	Nominal Input Voltage	48 V DC			
	Input Voltage Range	44–50 V DC			
	Maximal Power Consumption	150 W			
Optical	Light Source	High Power LED module			
	Colour Variants	RGBW (W – 2700 K or 4000 K) PureWhite Tunable White Tungsten Dim			
	Colour Temperature of White	PW 2700 K or 4000 K TW 2700–4000 K TD 3200 K			
	CRI	90+			
	Beam Angle	20° 30° 45° 60°			
	Lumen Output Delivered	7344 lm (RGBNW @ 20° 4000 K)			
		8707 lm (RGBNW @ 30° 4000 K)			
8865 lm (RGBNW @ 45° 4000 K)					
10,107 lm (RGBNW @ 60° 4000 K)					
Projected Lumen Maintenance	L90B10 >90.000 hrs, Ta = 25°C / 77°F				
Control	Interface Protocol	Standard	USITT DMX512, RDM, DALI 2, 0–10 V		
		Wireless	Lumen Radio CRMX Technology		
	DALI 2 Device Type	DT 8			
	Control System	ArcControl Range or any Third Party Controller			
	DMX Modes	5 (for RGBW version)			
	DMX Channels	4, 3, 12, 3, 6			
	Setting / Addressing	DIP Switch			
	Power Supply	Ambiane XP56 Recessed: Ambiane Power XP, Ambiane Power Rack or Third Party Constant Voltage 48 V / 150 W Power Supply			
		Ambiane XP56 Recessed /W: Ambiane Power XP, Ambiane Power Rack or Third Party Constant Voltage 48 V / 150 W Power Supply			
		Ambiane XP56 Recessed US: Ambiane Power XP, Ambiane Power Rack US or Third Party Constant Voltage 48 V / 150 W Power Supply			
Ambiane XP56 Recessed /W US: Ambiane Power XP, Ambiane Power Rack US or Third Party Constant Voltage 48 V / 150 W Power Supply					
Physical	Width × Height × Length	Ambiane XP56 Recessed 20°		Ø184 × 395 mm (Ø7.24 × 15.55 in.)	
		Ambiane XP56 Recessed 30°		Ø184 × 395 mm (Ø7.24 × 15.55 in.)	
		Ambiane XP56 Recessed 45°		Ø184 × 370 mm (Ø7.24 × 14.57 in.)	
		Ambiane XP56 Recessed 60°		Ø184 × 341 mm (Ø7.24 × 13.43 in.)	
	Weight	6.2 kg 13.66 lbs	6.2 kg 13.66 lbs	6.02 kg 13.27 lbs	5.9 kg 13 lbs
	Housing	High Pressure Extruded Aluminium Body, Plastic Cover			
	Finish Options	Standard Colour – Black RAL9005 White RAL9016			
		Cost Option – Custom RAL			
	Cables / Connections	Terminal Block (Power In, DMX In/Out, DALI In/Out, Secondary Power)			
	Mounting Method	Recessed, Via mounted bracket. Cut-Out Diameter: 186 mm / 7.32 in.			
Protection Factor	IP20 / Dry location only				
Cooling System	Convection				
Operating Ambient Temperature	–20 °C / +40 °C (–4 °F / +104 °F)				
Operating Temperature	+70 °C @ Ambient +40 °C (158 °F @ Ambient 104 °F)				
Certification	Listings	ETL / cETL, CE, RoHS, UKCA			
Accessories	Mounting Accessories	Trim for Ambiane XP56 Recessed			
		False Ceiling Mounting Adaptor			
	Optical Accessories	Louver 5° for Ambiane XP56 Recessed			
		Louver 10° for Ambiane XP56 Recessed			
	Power Supply Options	Ambiane Power XP (MeanWell ELG-240-48-3Y)			
		Ambiane Power Rack (CE / US)			

Ambiane™ XP56 Pendant

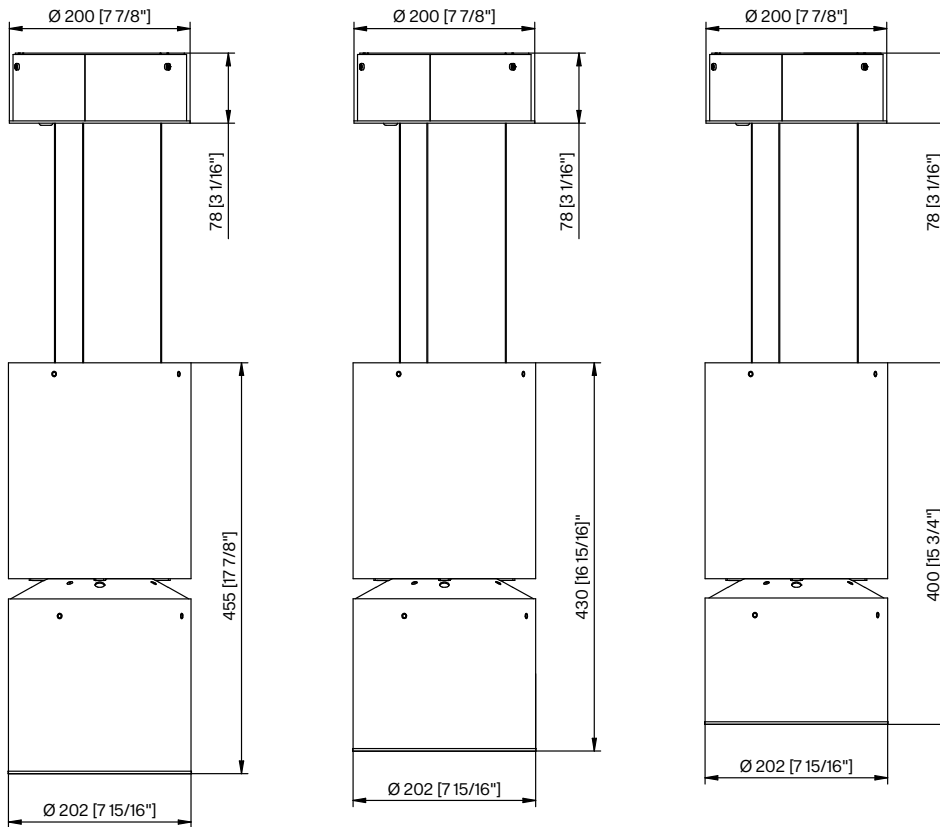

Luminous emittance 1 / Polar LDC

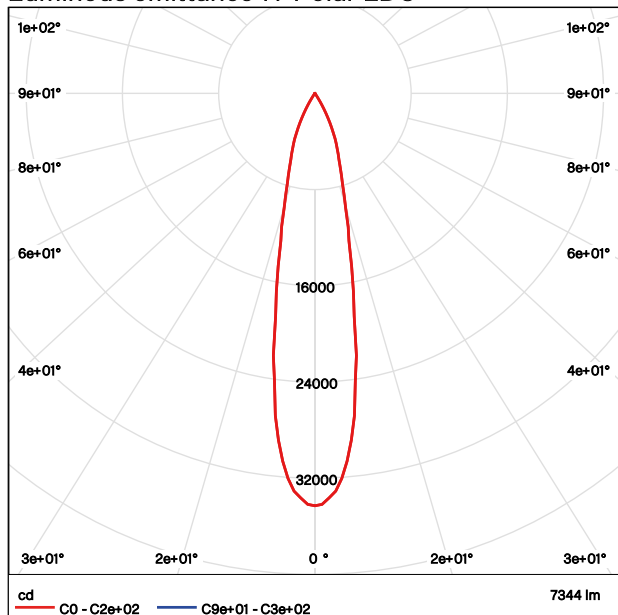

Luminous emittance 1 / Cone diagram

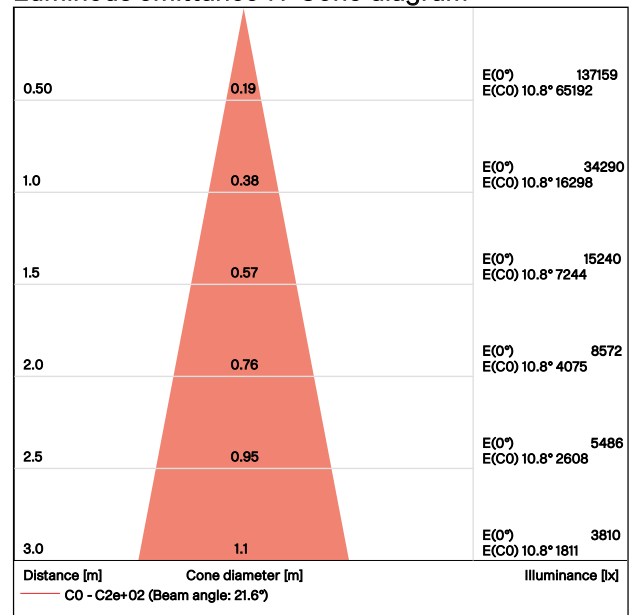

Electrical	Nominal Input Voltage	100–277 V DC (50–60Hz)			
	Typical Power Consumption	175 W ±10 %			
Optical	Light Source	High Power LED module			
	Colour Variants	RGBW (W – 2700 K or 4000 K) PureWhite Tunable White Tungsten Dim			
	Colour Temperature of White	PW 2700K or 4000K TW 2700–4000K TD 3200 K			
	CRI	90+			
	Beam Angle	20° 30° 45° 60°			
	Lumen Output Delivered	7344 lm (RGBNW @ 20° 4000K)			
		8707 lm (RGBNW @ 30° 4000K)			
8865 lm (RGBNW @ 45° 4000K)					
10,107 lm (RGBNW @ 60° 4000K)					
Projected Lumen Maintenance	L90B10 >90.000 hrs, Ta = 25°C / 77°F				
Control	Interface Protocol	Standard	USITT DMX512, RDM, DALI 2, 0–10 V		
		Wireless	Lumen Radio CRMX Technology		
	DALI 2 Device Type	DT 8			
	Control System	ArcControl Range or any Third Party Controller			
	DMX Modes	5 (for RGBW version)			
	DMX Channels	4, 3, 12, 3, 6			
	Setting / Addressing	DIP Switch			
	Power Supply	Integrated Power Supply			
Physical	Width × Height × Length	Ambiane XP56 Pendant 20°	Ø202 × 455 mm (Ø7.95 × 17.91 in.)		
		Ambiane XP56 Pendant 30°	Ø202 × 455 mm (Ø7.95 × 17.91 in.)		
		Ambiane XP56 Pendant 45°	Ø202 × 430 mm (Ø7.95 × 16.93 in.)		
		Ambiane XP56 Pendant 60°	Ø202 × 400 mm (Ø7.95 × 15.75 in.)		
		Surface Connection Terminal	Ø200 × 78 mm (Ø7.87 × 3.07 in.)		
	Weight	11.2 kg 24.69 lbs	11.2 kg 24.69 lbs	10.9 kg 24.03 lbs	10.9 kg 24.03 lbs
	Housing	High Pressure Extruded Aluminium Body, Metal cover			
	Finish Options	Standard Color – Black RAL9005 White RAL9016 Graphite Black RAL9011			
		Cost Option – Custom RAL			
	Cables / Connections	Terminal Block (Power In, DMX In/Out, DALI In/Out, Secondary Power)			
	Mounting Method	Pendant with 3 adjustable hanging wires:	Standard: 2.5 m (possibility of shorten on site)		
			Other Lengths: Upon Request (more than 2.5 m)		
	Protection Factor	IP20 / Dry location only			
Cooling System	Convection				
Operating Ambient Temperature	–20 °C / +40 °C (–4 °F / +104 °F)				
Operating Temperature (LED unit)	+75 °C @ Ambient +40 °C (167 °F @ Ambient 104 °F)				
Operating Temperature (Supply unit)	+70 °C @ Ambient +40 °C (158 °F @ Ambient 104 °F)				
Certification	Listings	ETL / cETL, CE, RoHS, UKCA			

Ambiane™ XP56 Pendant Remote

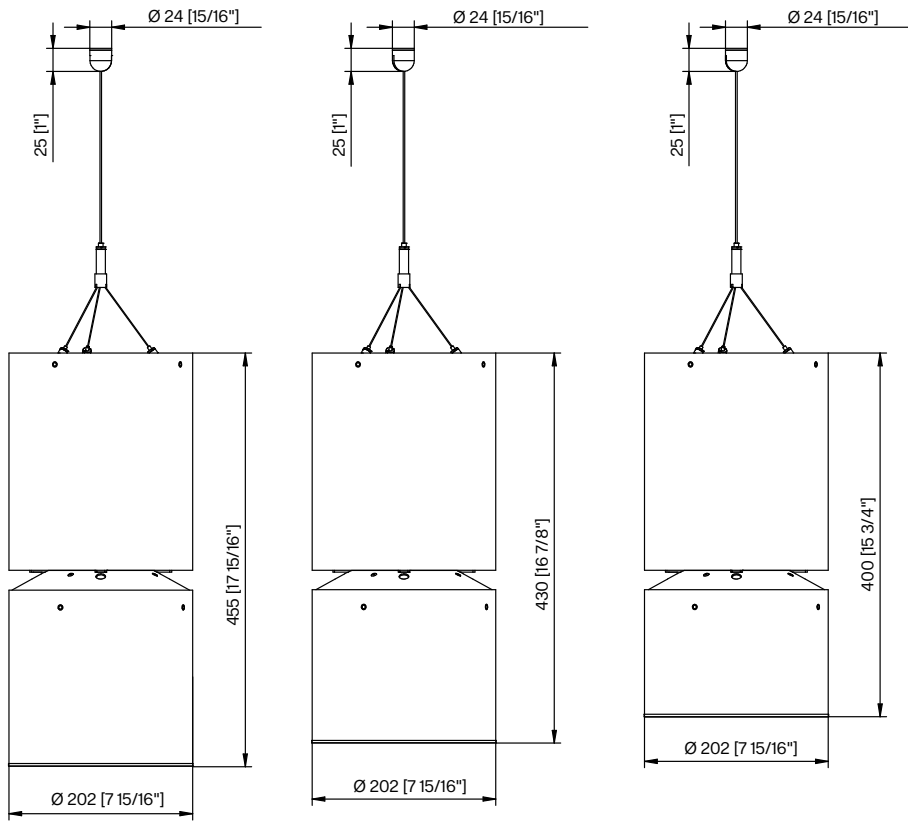

Luminous emittance 1 / Polar LDC

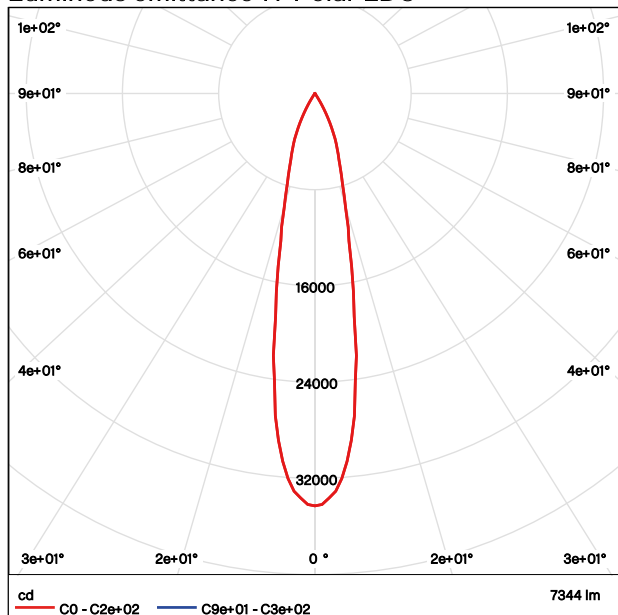

Luminous emittance 1 / Cone diagram

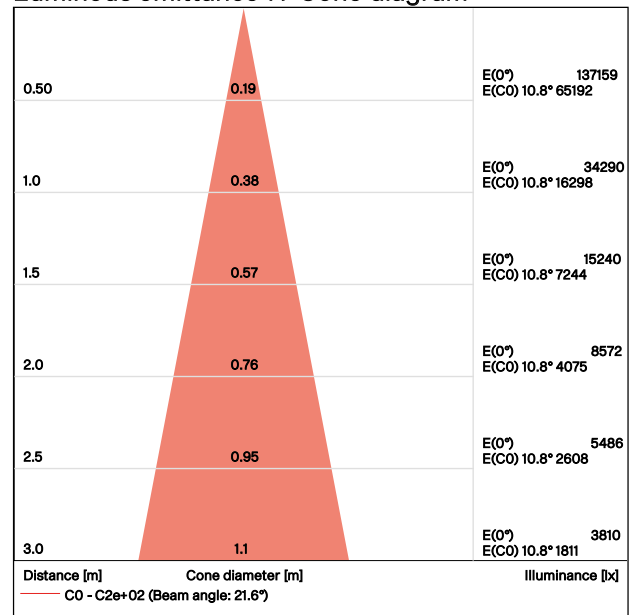

Electrical	Nominal Input Voltage	48 V DC			
	Input Voltage Range	44–50 V DC			
	Typical Power Consumption	150 W ±10 %			
Optical	Light Source	High Power LED module			
	Colour Variants	RGBW (W – 2700K or 4000K) PureWhite Tunable White Tungsten Dim			
	Colour Temperature of White	PW 2700 K or 4000K TW 2700–4000K TD 3200 K			
	CRI	90+			
	Beam Angle	20° 30° 45° 60°			
	Lumen Output Delivered	7344 lm (RGBNW @ 20° 4000K)			
		8707 lm (RGBNW @ 30° 4000K)			
8865 lm (RGBNW @ 45° 4000K)					
10,107 lm (RGBNW @ 60° 4000K)					
Projected Lumen Maintenance	L90B10 >90.000 hrs, Ta = 25°C / 77°F				
Control	Interface Protocol	USITT DMX512, RDM, DALI 2, 0–10 V			
	DALI 2 Device Type	DT 8			
	Control System	ArcControl Range or any Third Party Controller			
	DMX Modes	5 (for RGBW version)			
	DMX Channels	4, 3, 12, 3, 6			
	Setting / Addressing	DIP Switch			
	Power Supply	Ambiane XP56 Pendant Remote: Ambiane Power XP, Ambiane Power Rack or Third Party Constant Voltage 48 V / 150 W Power Supply			
		Ambiane XP56 Pendant Remote US: Ambiane Power XP, Ambiane Power Rack US or Third Party Constant Voltage 48 V / 150 W Power Supply			
Physical	Width × Height × Length	Ambiane XP56 Pendant Remote 20°		Ø202 × 455 mm (Ø7.95 × 17.91 in.)	
		Ambiane XP56 Pendant Remote 30°		Ø202 × 455 mm (Ø7.95 × 17.91 in.)	
		Ambiane XP56 Pendant Remote 45°		Ø202 × 430 mm (Ø7.95 × 16.93 in.)	
		Ambiane XP56 Pendant Remote 60°		Ø202 × 400 mm (Ø7.95 × 15.75 in.)	
		Connection Terminal		176 × 59 × 28 mm (6.93 × 2.32 × 1.10 in.)	
	Weight	9.3 kg 20.5 lbs	9.3 kg 20.5 lbs	9 kg 19.84 lbs	8.9 kg 19.62 lbs
		Housing			
	Finish Options	High Pressure Extruded Aluminium Body, Metal cover			
		Standard Color – Black RAL9005 White RAL9016 Graphite Black RAL9011 Cost Option – Custom RAL			
	Cables / Connections	Terminal Block (Power In, DMX In/Out, DALI In/Out, Secondary Power)			
	Mounting Method	Pendant with 1 adjustable hanging wire: Standard: 2.5 m (possibility of shorten on site) Other Lengths: Upon Request (more than 2.5 m)			
	Protection Factor	IP20			
Cooling System	Convection				
Operating Ambient Temperature	–20 °C / +40 °C (–4 °F / +104 °F)				
Operating Temperature	+75 °C @ Ambient +40 °C (167 °F @ Ambient 104 °F)				
Certification	Listings	ETL / cETL, CE, RoHS, UKCA			
Accessories	Power Supply Options	Ambiane Power XP (MeanWell ELG-240-48-3Y)			
		Ambiane Power Rack (CE / US)			

Ambiane™ HP111 Recessed

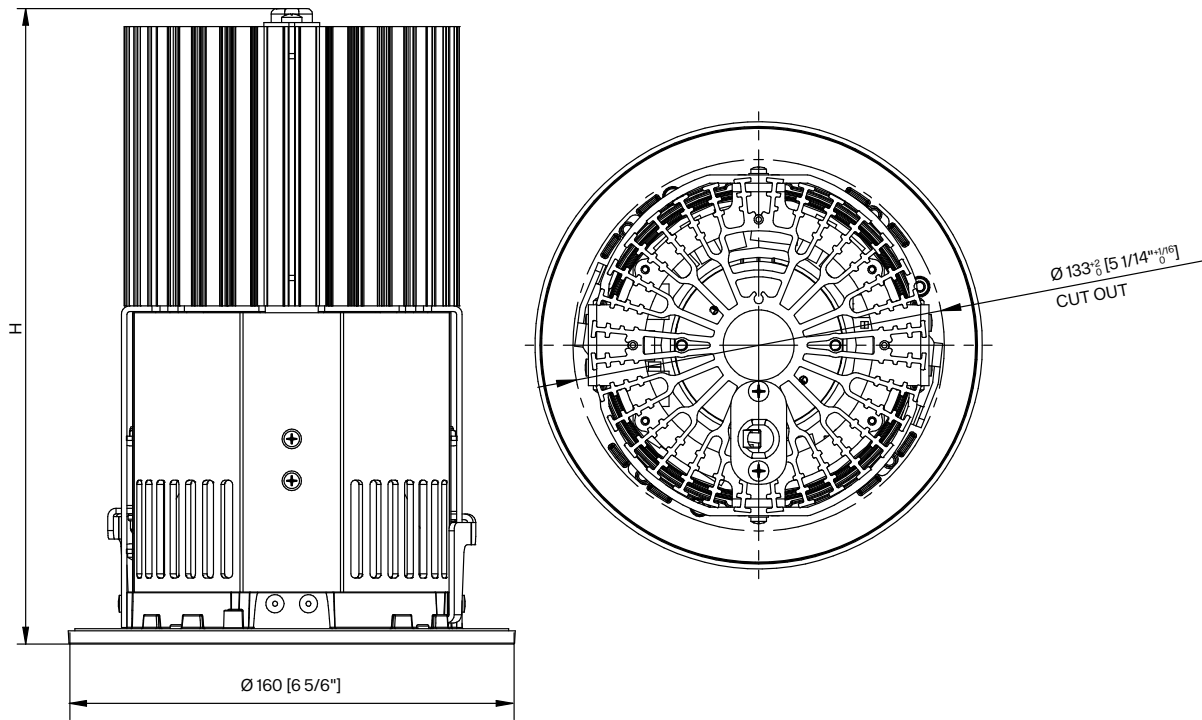

Ambiane HP 20° H = 224 [8 13/16"]

Ambiane HP 40° H = 227 [8 15/16"]

Ambiane HP 60° H = 210 [8 1/4"]

Ambiane HP 80° H = 194 [7 5/8"]

Luminous emittance 1 / Polar LDC

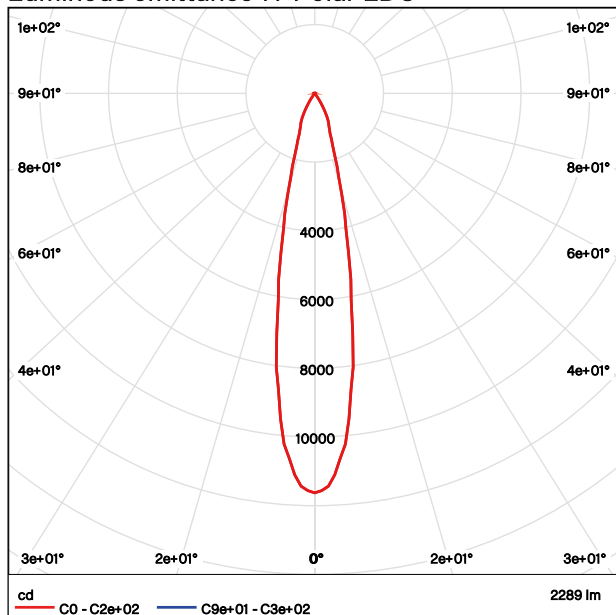

Luminous emittance 1 / Cone diagram

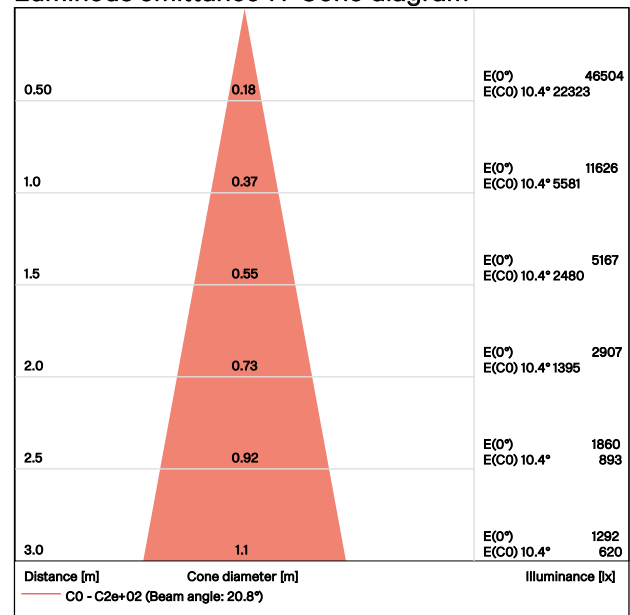

Electrical	Input Voltage	48 V DC		
	Input Voltage range	44–50 V DC		
	Max. Power Consumption (Primary power Secondary power)	75 W 20 W		
	Max. Operating time for Sec. power	3 hrs		
Optical	Light Source	High Power LED module		
	Colour Variants	RGBW (W 2700 K or 4000 K) Pure White Tunable White Tungsten Dim		
	Colour Temperature of White	PW 2700 K or 4000 K TW 2700–4000 K TD 3200 K		
	CRI	90+		
	Beam Angle	20° 40° 60° 80°		
	Lumen Output Delivered	2.289 lm (RGBNW at 20° 4000 K)	3.239 lm (RGBNW at 60° 4000 K)	
		3.024 lm (RGBNW at 40° 4000 K)	3.145 lm (RGBNW at 80° 4000 K)	
Projected Lumen Maintenance	L90B10 >90.000 hrs, Ta = 25°C / 77°F			
Control	Interface Protocol	USITT DMX512, RDM, DALI 2, 0–10 V		
	DALI 2 Device Type	DT 8		
	Control System	ArcControl Range or any Third Party Controller		
	DMX Modes DMX Channels	5 (for RGBW version) 4, 3, 12, 3, 6		
	Settings / Addressing	DIP Switch		
	Power Supply	Ambiane Power HP (48 V / 100 W)	Ambiane Power Rack (CE/US)	
Physical	Width × Height × Depth Weight	Ambiane HP111 Recessed 20° – Ø160 × 224 mm (Ø6.2 × 8.7 in.)	2.1 kg 4.6 lbs @ 20°	
		Ambiane HP111 Recessed 40° – Ø160 × 227 mm (Ø6.2 × 8.9 in.)	2.1 kg 4.6 lbs @ 40°	
		Ambiane HP111 Recessed 60° – Ø160 × 210 mm (Ø6.2 × 8.2 in.)	2.0 kg 4.4 lbs @ 60°	
		Ambiane HP111 Recessed 80° – Ø160 × 194 mm (Ø6.2 × 7.6 in.)	2.0 kg 4.4 lbs @ 80°	
	Housing	High Pressure Extruded Aluminium Body		
	Finish Options	Standard Color – White RAL9016 Black RAL9005 Cost Option – Custom RAL		
	Cables / Connections	Terminal block (Power In, DMX In/Out, DALI In/Out, Secondary Power Input)		
	Mounting Method	Recessed, Via mounted bracket. Cut-Out Diameter: 133 mm / 5.24 in		
		Recessed, Via Yoke		
	Protection Factor	IP20 / Dry location only		
Cooling System	Convection			
Operating Ambient Temperature (Primary power / Secondary power)	–20 °C / +40 °C (–4 °F / +104 °F) –20 °C / +70 °C (–4 °F / +158 °F)			
Max. Operating Temperature	+75°C (167°F)			
Certification	Listings	ETL / cETL, RoHS, CE (including ČSN EN 60598-2-22 / Emergency lighting, ISO17067), UKCA		
Accessories	Ambiane Power HP (MeanWell ELG-100-48-3Y)			
	Ambiane Power Rack (CE/US)			
	Ring Louver for Ambiane HP Recessed 20°			

Ambiane™ HP111 Pendant Remote

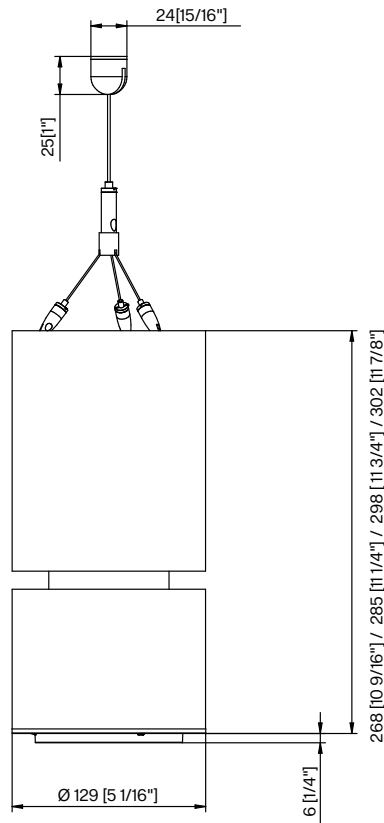

Luminous emittance 1 / Polar LDC

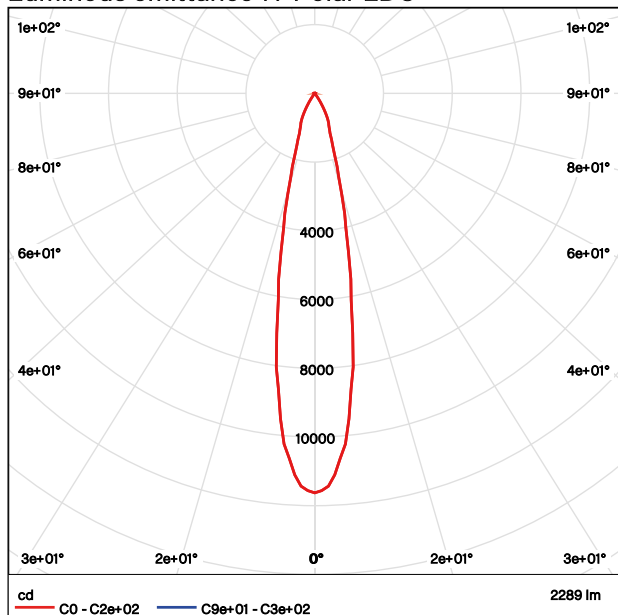

Luminous emittance 1 / Cone diagram

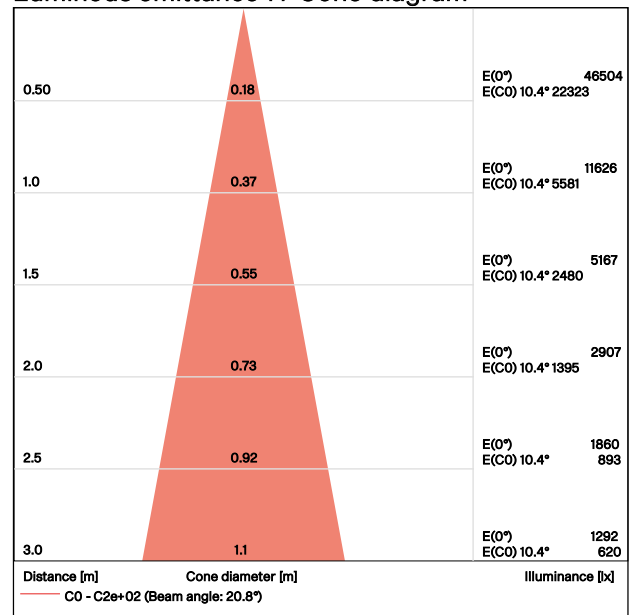

Electrical	Input Voltage	48 V DC
	Input Voltage range	44–50 V DC
	Max. Power Consumption	75 W
Optical	Light Source	High Power LED module
	Colour Variants	RGBW (W – 2700 K or 4000 K) PureWhite Tunable White Tungsten Dim
	Colour Temperature of White	PW 2700 K or 4000 K TW 2700–4000 K TD 3200 K
	CRI	90+
	Beam Angle	20° 40° 60° 80°
	Lumen Output Delivered	2289 lm (RGBNW at 20° 4000 K)
		3024 lm (RGBNW at 40° 4000 K)
		3239 lm (RGBNW at 60° 4000 K)
		3145 lm (RGBNW at 80° 4000 K)
Projected Lumen Maintenance	L90B10 >90.000 hrs, Ta = 25°C / 77°F	
Control	Interface Protocol	USITT DMX512, RDM, DALI 2, 0–10 V
	DALI 2 Device Type	DT 8
	Control System	ArcControl Range or any Third Party Controller
	DMX Modes	5 (for RGBW version)
	DMX Channels	4, 3, 12, 3, 6
	Settings / Addressing	DIP Switch
	Power Supply	Ambiane Power HP (48 V / 100 W)
		Ambiane Power Rack (CE/US)
Physical	Width × Height × Depth	Ambiane HP111 Pendant Remote 20° – Ø129 × 302 mm (Ø5.08 × 11.9 in.)
		Ambiane HP111 Pendant Remote 40° – Ø129 × 298 mm (Ø5.08 × 11.73 in.)
		Ambiane HP111 Pendant Remote 60° – Ø129 × 285 mm (Ø5.08 × 11.22 in.)
		Ambiane HP111 Pendant Remote 80° – Ø129 × 268 mm (Ø5.08 × 10.55 in.)
	Weight	3.1 kg 6.8 lbs @ 20° 3.1 kg 6.8 lbs @ 40° 3 kg 6.6 lbs @ 60° 3 kg 6.6 lbs @ 80°
	Housing	High Pressure Extruded Aluminium Body
	Finish Options	Standard Colour – White RAL9016 Black RAL9005 Graphite Black RAL9011
		Cost Option – Custom RAL
	Cables / Connections	Terminal block (Power In, DMX In/Out, DALI In/Out, Secondary Power Input)
	Mounting Method	Pendant with adjustable hanging wires: Standard: 2.5 m (possibility of shortening on site) Other Lengths: Upon Request (more than 2.5 m)
	Protection Factor	IP20 / Dry location only
Cooling System	Convection	
Operating Ambient Temperature	-20 °C / +40 °C (-4 °F / +104 °F)	
Max. Operating Temperature	+75 °C (167 °F)	
Certification	Listings	ETL / cETL, RoHS, CE, UKCA
Accessories		Ambiane Power HP (MeanWell ELG-100-48-3Y)
		Ambiane Power Rack (CE/US)
		Ring Louver for Ambiane HP111 Pendant Remote 20°

Ambiane™ HP111 Surface Mount

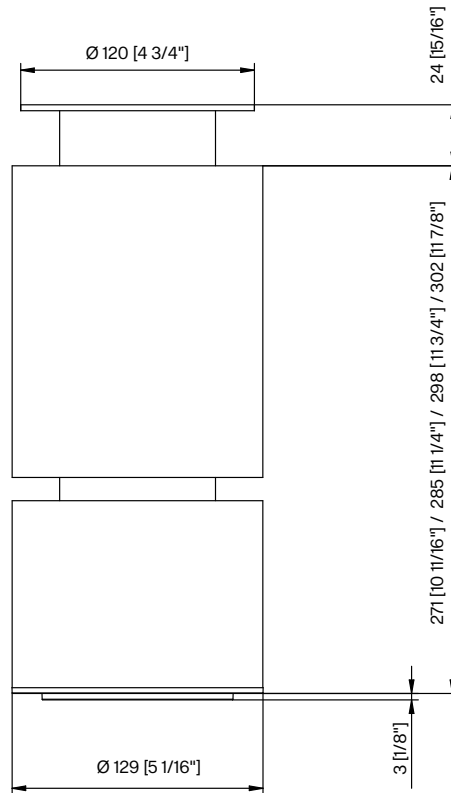

Luminous emittance 1 / Polar LDC

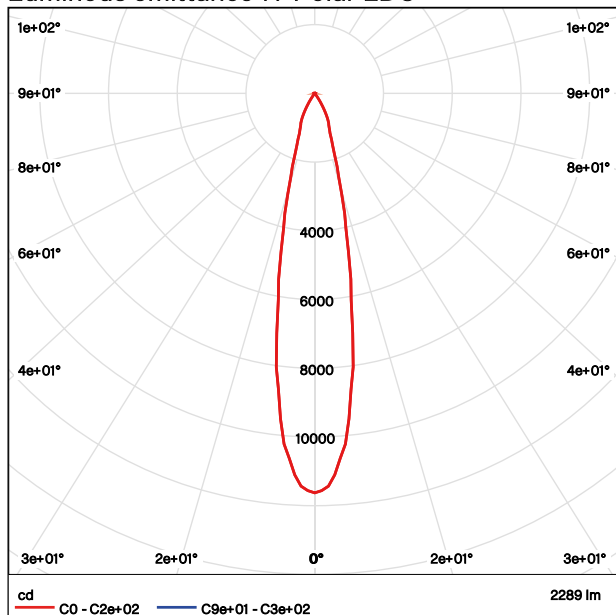

Luminous emittance 1 / Cone diagram

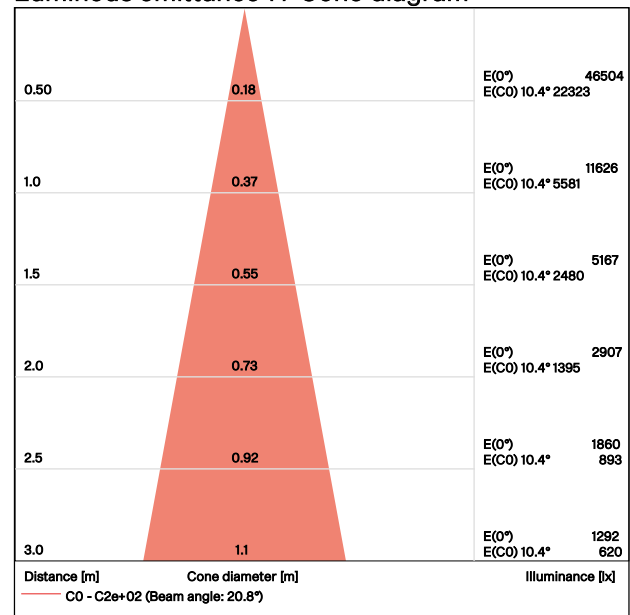

Electrical	Input Voltage	48 V DC
	Input Voltage range	44–50 V DC
	Max. Power Consumption	75 W
Optical	Light Source	High Power LED module
	Colour Variants	RGBW (W – 2700 K or 4000 K) PureWhite Tunable White Tungsten Dim
	Colour Temperature of White	PW 2700 K or 4000 K TW 2700–4000 K TD 3200 K
	CRI	90+
	Beam Angle	20° 40° 60° 80°
	Lumen Output Delivered	2289 lm (RGBNW at 20° 4000 K)
		3024 lm (RGBNW at 40° 4000 K)
3239 lm (RGBNW at 60° 4000 K)		
3145 lm (RGBNW at 80° 4000 K)		
Projected Lumen Maintenance	L90B10 >90.000 hrs, Ta = 25°C / 77°F	
Control	Interface Protocol	USITT DMX512, RDM, DALI 2, 0–10 V
	DALI 2 Device Type	DT 8
	Control System	ArcControl Range or any Third Party Controller
	DMX Modes	5 (for RGBW version)
	DMX Channels	4, 3, 12, 3, 6
	Settings / Addressing	DIP Switch
	Power Supply	Ambiane Power HP (48 V / 100 W)
Ambiane Power Rack (CE/US)		
Physical	Width × Height × Depth	Ambiane HP111 Surface Mount 20° – Ø129 × 302 mm (Ø5.08 × 11.9 in.)
		Ambiane HP111 Surface Mount 40° – Ø129 × 298 mm (Ø5.08 × 11.73 in.)
		Ambiane HP111 Surface Mount 60° – Ø129 × 285 mm (Ø5.08 × 11.22 in.)
		Ambiane HP111 Surface Mount 80° – Ø129 × 268 mm (Ø5.08 × 10.55 in.)
	Weight	2.6 kg 5.7 lbs @ 20° 2.6 kg 5.7 lbs @ 40° 2.5 kg 5.5 lbs @ 60° 2.5 kg 5.5 lbs @ 80°
	Housing	High Pressure Extruded Aluminium Body
	Finish Options	Standard Colour – White RAL9016 Black RAL9005 Graphite Black RAL9011
		Cost Option – Custom RAL
	Cables / Connections	Terminal block (Power In, DMX In/Out, DALI In/Out, Secondary Power Input)
	Mounting Method	Via Mounting Adaptor
	Protection Factor	IP20 / Dry location only
Cooling System	Convection	
Operating Ambient Temperature	–20 °C / +40 °C (–4 °F / +104 °F)	
Max. Operating Temperature	+75 °C (167 °F)	
Certification	Listings	ETL / cETL, RoHS, CE, UKCA
Accessories		Ambiane Power HP
		Ring Louver for Ambiane HP111 Pendant Remote 20°
		Ambiane Power Rack (CE/US)

Ambiane™ AP

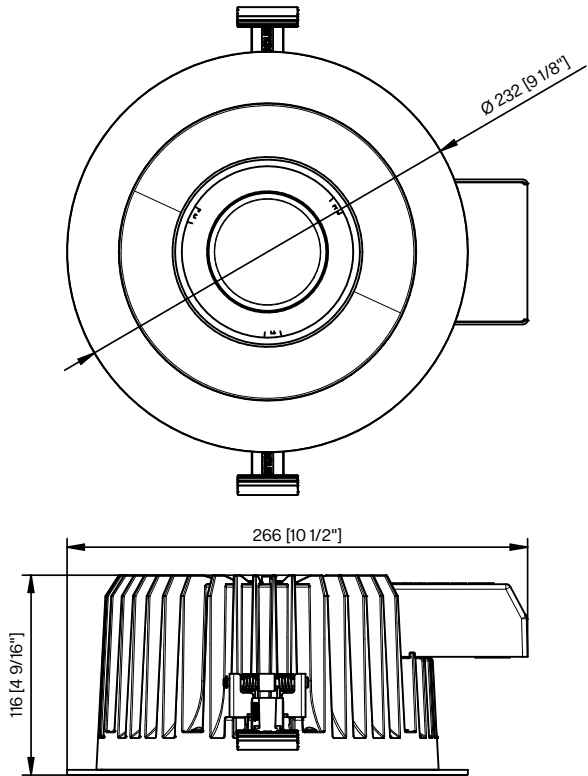
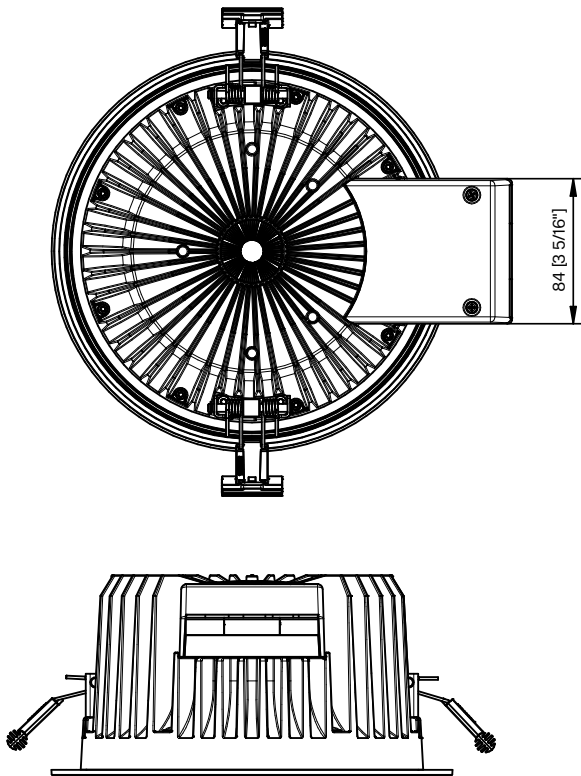

Luminous emittance 1 / Polar LDC

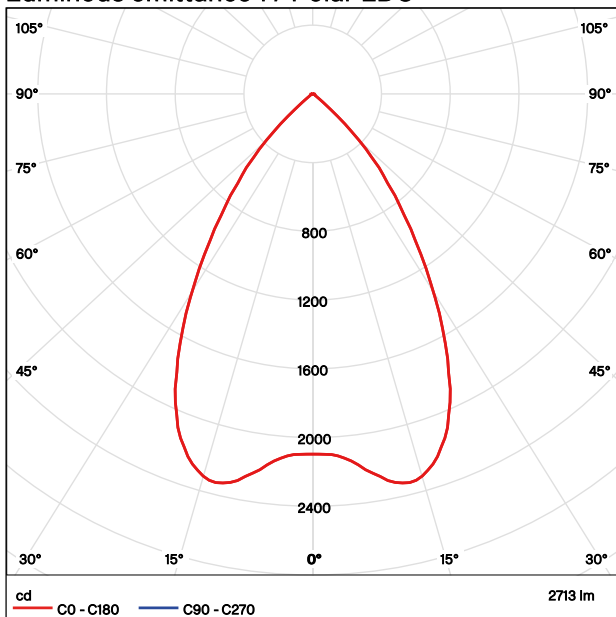

Luminous emittance 1 / Cone diagram

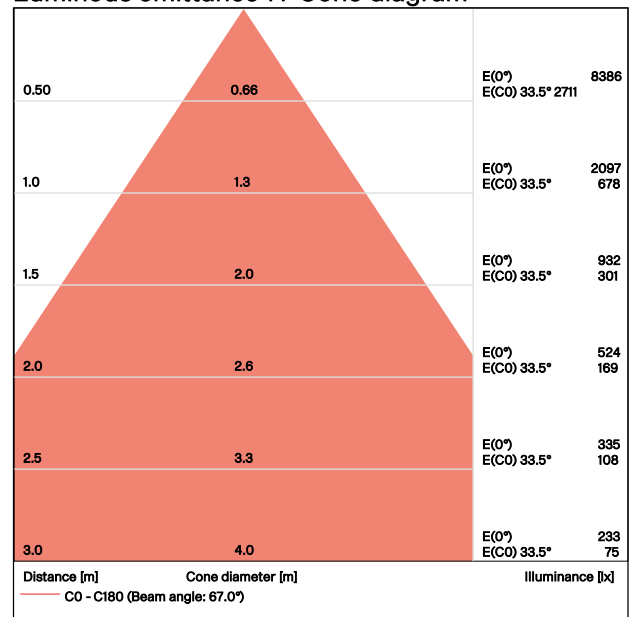

Electrical	Input Voltage	48 V DC
	Typical Power Consumption	50 W
Optical	Light Source	High Power Single Chip LEDs
	Colour Variants	RGBW (W – 2700 K or 4000 K) PureWhite Tunable White Tungsten Dim
	Colour Temperature of White	PW 2700 K or 4000 K TW 2700–4000 K TD 3200 K
	CRI	90+
	Beam Angle	67° 80°
	Lumen Output Delivered	2713 lm (RGBNW 4000 K @ 67°) 2495 lm (RGBNW 4000 K @ 80°)
	Projected Lumen Maintenance	L90B10 >90.000 hrs, Ta = 25°C / 77°F
Control	Interface Protocol	USITT DMX512, RDM, DALI 2, 0–10 V
	DALI 2 Device Type	DT 8
	Control System	ArcControl Range or any Third Party Controller
	DMX Modes	5 (for RGBW version)
	DMX Channels	4, 3, 12, 3, 6
	Settings / Addressing	DIP Switch
	Power Supply	Ambiane Power AP, Ambiane Power Rack (CE/US) or Third Party Constant Voltage 48 V / 75 W Power Supply
Physical	Width × Height × Depth	Ø232 × 116 × 266 mm (Ø9.13 × 4.57 × 10.47 in.)
	Weight	1.9 kg 4.19 lbs
	Housing	High Pressure Die-Cast Aluminium Body
	Finish Options	Standard Colour – White RAL 9016, Black RAL 9005 Cost Option – Custom RAL
	Cables / Connections	Terminal Block (Power In, DMX In/Out, DALI In/Out, Secondary power Input)
	Mounting Method	Recessed, Via Two Spring Clips. Cut-Out Diameter: 212 mm / 8.34 in.
	Protection Factor	IP20 (Option: Below part IP54 with attached front clear or frosted glass – valid for part of the luminaire with glass under the ceiling)
	IK Rating	IK08 (IP54 option with Clear Glass) IK06 (IP54 option with Frosted Glass)
	Cooling System	Convection
	Operating Ambient Temperature	–20 °C / +45 °C (–4 °F / +113 °F)
	Operating Temperature	+75 °C @ Ambient +35 °C (167 °F @ Ambient 95 °F)
Certification	Listings	ETL / cETL, CE, RoHS, UKCA
Accessories	Mounting	Adapter Ring for Ø235–255 mm + Spring Clip Set
	Optical	Anti-Glare Ring
	Power supply	Ambiane Power AP (MeanWell ELG-75-48-3Y) Ambiane Power Rack (CE / US)

Ambiane™ SP16

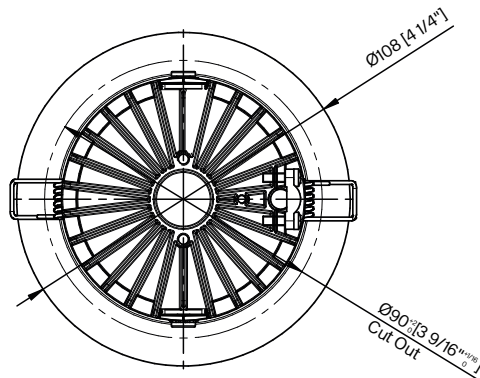
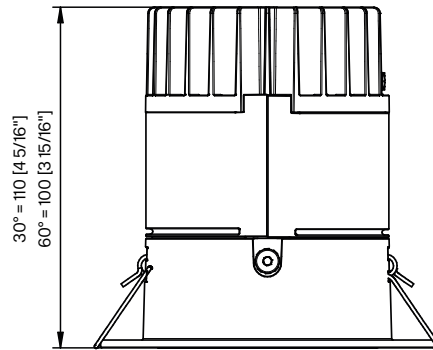
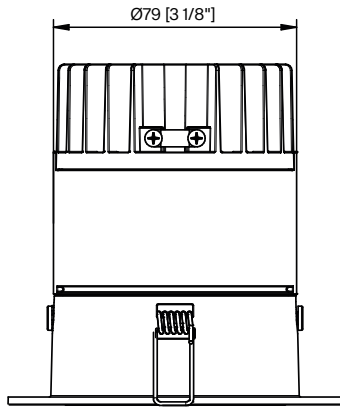

Luminous emittance 1 / Polar LDC

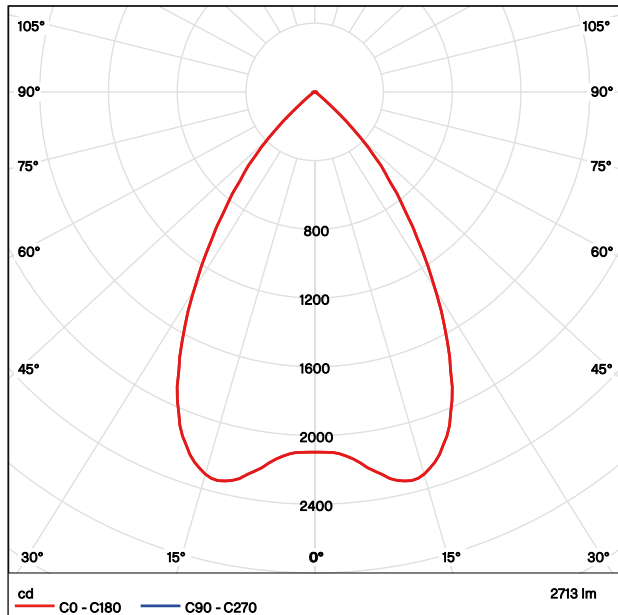

Luminous emittance 1 / Cone diagram

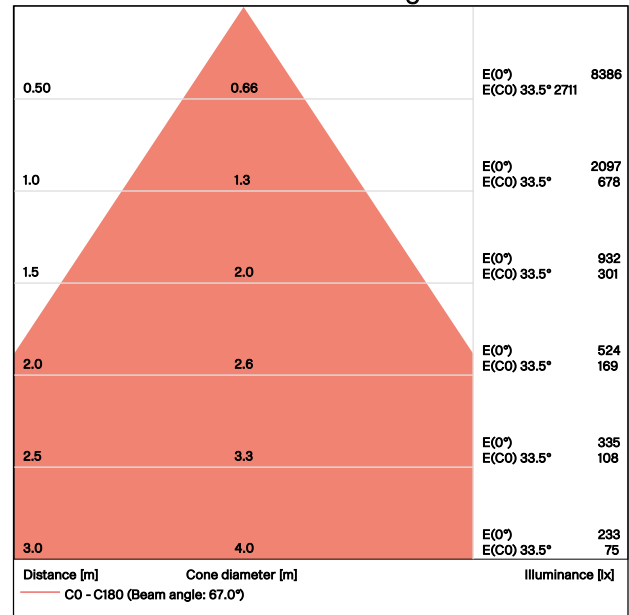

Electrical	Input Voltage	48 V DC
	Input Voltage range	44–50 V DC
	Max. Power Consumption	12 W
Optical	Light Source	High Power LED module
	Colour Variants	RGBW (W – 2700 K or 4000 K) PureWhite Tunable White Tungsten Dim
	Colour Temperature of White	PW 2700 K or 4000 K TW 2700–4000 K TD 3200 K
	CRI	90+
	Beam Angle	30° 60°
	Lumen Output Delivered	350 lm (RGBW at 30° 2700 K) 365 lm (RGBW at 60° 2700 K)
	Projected Lumen Maintenance	L90B10 >90.000 hrs, Ta = 25°C / 77°F
Control	Interface Protocol	USITT DMX512, RDM, DALI 2, 0–10 V
	DALI 2 Device Type	DT 8
	Control System	ArcControl Range or any Third Party Controller
	DMX Modes	5 (for RGBW version)
	DMX Channels	4, 3, 12, 3, 6
	Settings / Addressing	DIP Switch, RDM
	Power Supply	Ambiance Power SP
Physical	Diameter × Height	Ambiance SP 30° – Ø108 × 110 mm (Ø4.2 × 4.3 in.) Ambiance SP 60° – Ø108 × 100 mm (Ø4.2 × 3.9 in.)
	Weight	0.35 kg 0.77 lbs @ 30° 0.35 kg 0.77 lbs @ 60°
	Housing	Die-Cast Aluminium Body
	Finish Options	Standard Colour – White RAL9016 Black RAL9005 Cost Option – Custom RAL
	Cables / Connections	Terminal block (Power In, DMX In/Out, DALI In/Out)
	Mounting Method	Recessed, Via mounted bracket. Cut-Out Diameter: 80 mm / 3.15 in Recessed, Via Yoke
	Protection Factor	IP20 / Dry location only
	Cooling System	Convection
	Operating Ambient Temperature	–20 °C / +40 °C (–4 °F / +104 °F)
	Max. Operating Temperature	+75 °C (167 °F)
	Certification	Listings
Accessories		Ambiance Power SP

ProMotion™

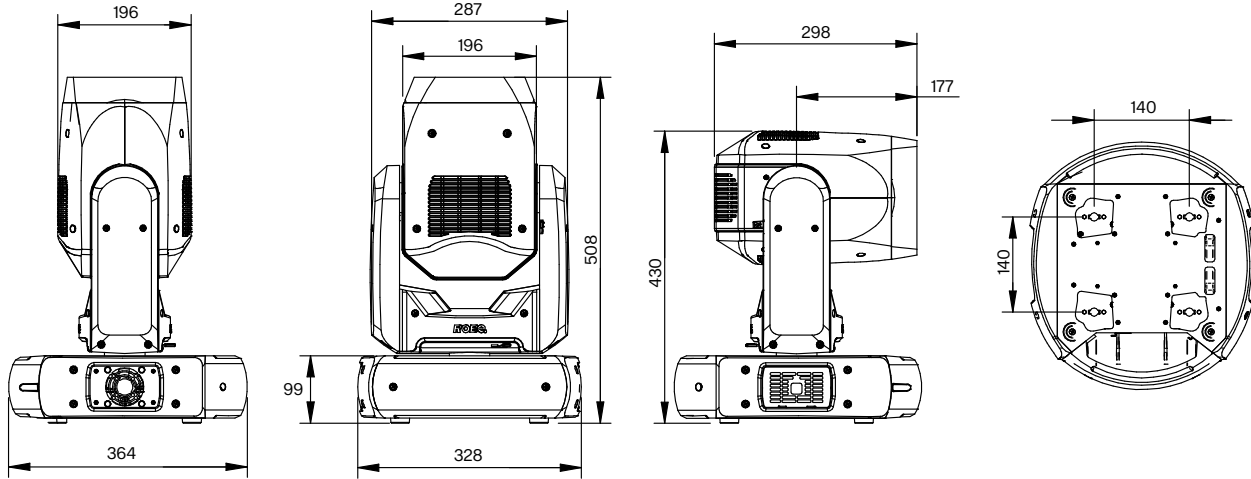

Standard Lens Throw distance ratio 3.5 : 1

Illuminance - centre
(white output: Max. Brightness)

Image Size

lx / fc	Height (m / ft)	X (m / ft)	Y (m / ft)
118 lx / 11 fc	14m (46')	X=4.0m (13.12')	Y=2.25m (7.38')
137 lx / 13 fc	13m (43')	X=3.71m (12.10')	Y=2.08m (6.82')
161 lx / 15 fc	12m (39')	X=3.43m (11.25')	Y=1.93m (6.33')
192 lx / 18 fc	11m (36')	X=3.14m (10.31')	Y=1.78m (5.84')
232 lx / 22 fc	10m (33')	X=2.86m (9.37')	Y=1.61m (5.28')
286 lx / 27 fc	9m (30')	X=2.57m (8.44')	Y=1.45m (4.76')
362 lx / 34 fc	8m (26')	X=2.29m (7.05')	Y=1.29m (4.23')
473 lx / 44 fc	7m (23')	X=2.0m (6.56')	Y=1.13m (3.71')
643 lx / 60 fc	6m (20')	X=1.71m (5.62')	Y=0.96m (3.15')
927 lx / 86 fc	5m (16')	X=1.43m (4.69')	Y=0.80m (2.62')
1448 lx / 135 fc	4m (13')	X=1.14m (3.75')	Y=0.64m (2.10')
2575 lx / 239 fc	3m (10')	X=0.86m (2.81')	Y=0.48m (1.57')
5794 lx / 538 fc	2m (7')	X=0.57m (1.87')	Y=0.32m (1.05')

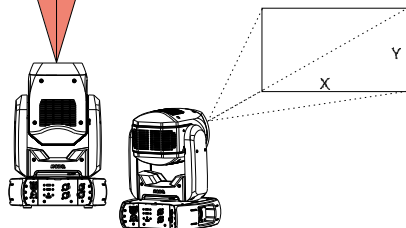

Wide lens Throw distance ratio 2.3 : 1

Illuminance - centre
(white output: Max. Brightness)

Image Size

lx / fc	Height (m / ft)	X (m / ft)	Y (m / ft)
50 lx / 4.6 fc	14m (46')	X=6.14m (20.15')	Y=3.45m (11.32')
57 lx / 5.3 fc	13m (43')	X=5.7m (18.71')	Y=3.20m (10.50')
67 lx / 6.3 fc	12m (39')	X=5.26m (17.27')	Y=2.96m (9.71')
80 lx / 7.4 fc	11m (36')	X=4.82m (15.83')	Y=2.71m (8.89')
97 lx / 9 fc	10m (33')	X=4.39m (14.39')	Y=2.47m (8.10')
120 lx / 11.1 fc	9m (30')	X=3.95m (12.95')	Y=2.22m (7.28')
152 lx / 14 fc	8m (26')	X=3.51m (11.51')	Y=1.97m (6.46')
198 lx / 18.4 fc	7m (23')	X=3.07m (10.07')	Y=1.73m (5.68')
270 lx / 25 fc	6m (20')	X=2.63m (8.63')	Y=1.48m (4.86')
388 lx / 36 fc	5m (16')	X=2.19m (7.19')	Y=1.23m (4.04')
606 lx / 56 fc	4m (13')	X=1.75m (5.76')	Y=0.98m (3.22')
1078 lx / 100 fc	3m (10')	X=1.32m (4.32')	Y=0.74m (2.43')
2125 lx / 225 fc	2m (7')	X=0.88m (2.88')	Y=0.50m (1.64')

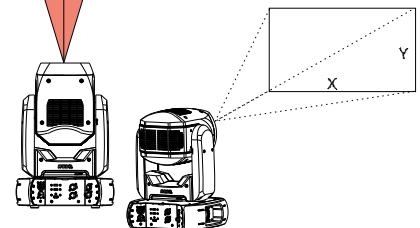

Source	Light Source Type	RGB LED device
	Lifetime	20,000 hrs
		Eco mode: extended life time of LED source
Projector Specifications	Light Output	1000 ANSI lumens (Comparable with 5000 ANSI lumen lamp projectors)
	Aspect Ratio	16:9
	Resolution	1920 × 1080
	Beam Angle	17°
	Throw Ratio	3.5
	Contrast Ratio	500:1
	Display Colours	16.7 million colours
	Optional Wide Lens	26°
	Throw Ratio Wide Lens	2.3
Main Features		Colour Mixing mode RGB/CMY
	White Light	Variable CCT 3200 K – 9500 K
	Colour effect wheel with wide range of in-built effects	Colour transitions and cross-fades, multiple colour images, rainbow effects
	Digital gobo wheel 1	With standard gobos, images and videos
	Digital gobo wheel 2	With user's gobos, images and videos
		Gobo rotation and indexing
		Live input via external High Definition Multimedia Interface
		Effect speed control
	Keystoning	Horizontal / Vertical
	ADM™ Automatic distance meter	Upon Request
		Grey box correction
	Motorized focus	
	Pre-programmed random stROBE & pulse effects	
	Dimmer	0–100%
Control & Programming	Setting & Addressing	ROBE Graphic Touch Screen (50 × 40 mm / 1.97" × 1.57")
	Protocol	USITT DMX-512, RDM, ArtNet, MA Net, MA Net2, sACN
		REAP™ – ROBE Ethernet Access Portal
	Wireless CRMX™ technology from Lumen Radio	Upon Request
	RTC (Real-time clock)	Built-in device to keep track of actual time in order to start and stop playback at given time
		Stand-alone operation
Content Management		Upload and projection of custom artwork, still photographs and videos from USB memory stick
		Remote content management
	Internal Storage	High speed internal memory for user content – 32 GB
	NAS client	Automatic content synchronization tool
	Live video stream	From remote source
Hardware		Raspberry Pi, Model 3, 1 GB
Operating System		Linux OS

E-Box™ Lite

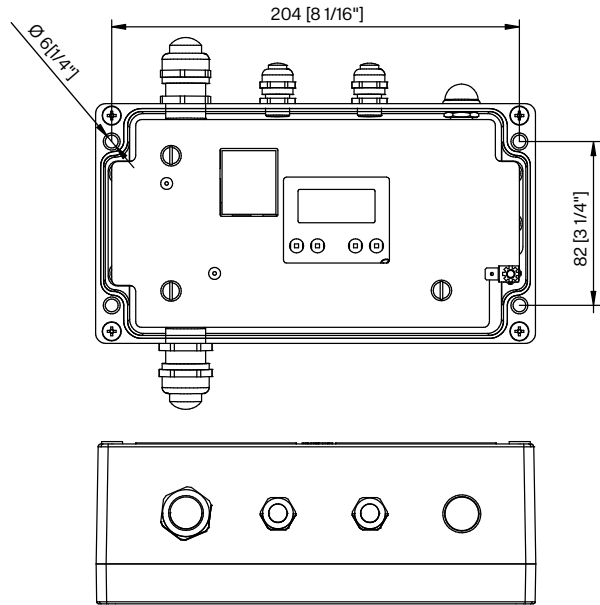
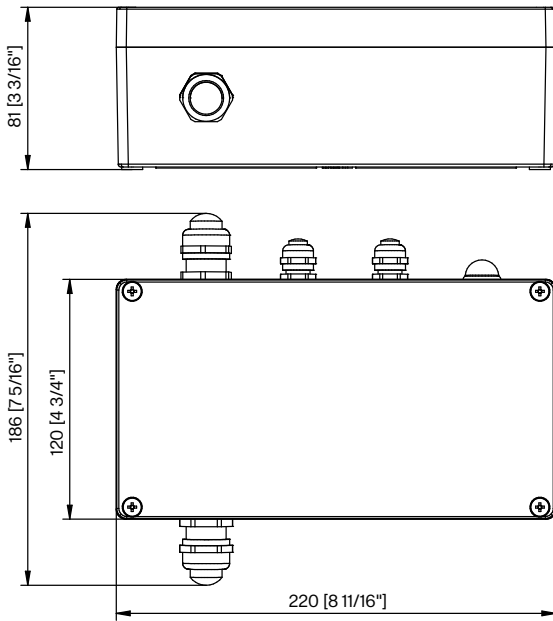

Electrical	Input Voltage	120–277 V AC 50 / 60 Hz
	Typical Power Consumption	5 W (self consumption)
	Max. Output Current	16 A
Control	Wireless DMX (Option)	Lumen Radio CRMX Technology
	Interface Protocol	USITT DMX512, RDM
	Operating Modes	DMX, Stand-alone
	Display	Two Row LCD and Control Buttons
Physical	Width × Height × Depth	220 × 81 × 120 mm (8.66 × 3.18 × 4.72 in.)
	Weight	1.67 kg / 3.85 lbs
	Number of LED Output zones	1
	Max. Load Per Output	144 pcs of Eminere 1 with 40 m total cable length @ 230 V
		78 pcs of Eminere 2 with 30 m total cable length @ 230 V
		53 pcs of Eminere 3 with 30 m total cable length @ 230 V
		40 pcs of Eminere 4 with 30 m total cable length @ 230 V
	DMX Modes	Fixture Mode, Pixel Mode, Output Mode
	Editable Programs	3 (up to 40 steps each)
	Eminere Output Connection	Leader Cable – Combo Power And Data
	Finish Options	Standard Colour – Graphite Black (RAL 9011) Silver (RAL 9006)
		Cost Option – Custom RAL Harsh Environment (RAL 9016, RAL 9011)
	Mounting Method	4 Mounting Holes
	Protection Factor	IP67, Suitable For Wet Location
	IK Rating	IK10
Cooling System	Convection	
Operating Temperature Range	-20 °C / +40 °C (-4 °F / +104 °F)	
Certification	Listings	ETL / cETL, CE, RoHS, UKCA

E-Box™ Daisy

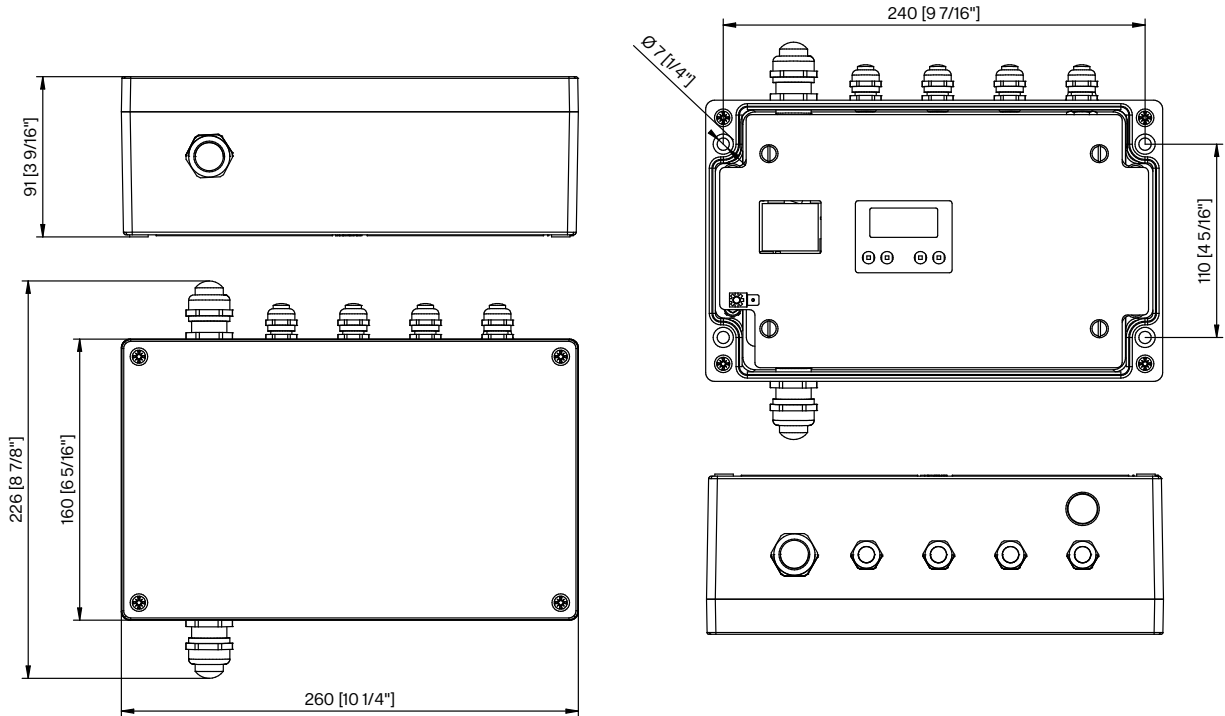

Electrical	Input Voltage	120–277 V AC 50 / 60 Hz
	Typical Power Consumption	5 W (self consumption)
	Max. Output Current	16 A
Control	Wireless DMX (Option)	Lumen Radio CRMX Technology
	Interface Protocol	USITT DMX512, RDM, ArtNet, MA Net, MA Net2, sACN, Kling-Net
	Operating Modes	DMX, Stand-alone
	Display	Two Row LCD and Control Buttons
Physical	Width × Height × Depth	260 × 160 × 91 mm (10.24 × 6.3 × 3.58 in.)
	Weight	2.78 kg / 6.13 lbs
	Number of LED Output zones	1
	Max. Load Per Output	144 pcs of Eminere 1 with 40 m total cable length @ 230 V
		78 pcs of Eminere 2 with 30 m total cable length @ 230 V
		53 pcs of Eminere 3 with 30 m total cable length @ 230 V
		40 pcs of Eminere 4 with 30 m total cable length @ 230 V
	DMX Modes	Fixture Mode, Pixel Mode, Output Mode
	Editable Programs	3 (up to 40 steps each)
	Eminere Output Connection	Leader Cable – Combo Power and Data
	Finish Options	Standard Colour – Graphite Black (RAL 9011) Silver (RAL 9006)
		Cost Option – Custom RAL Harsh Environment (RAL 9016, RAL 9011)
	Mounting Method	4 Mounting Holes
	Protection Factor	IP67, Suitable For Wet Location
	IK Rating	IK10
Cooling System	Convection	
Operating Temperature Range	-20 °C / +40 °C (-4 °F / +104 °F)	
Certification	Listings	ETL / cETL, CE, RoHS, UKCA

E-Box™ Star

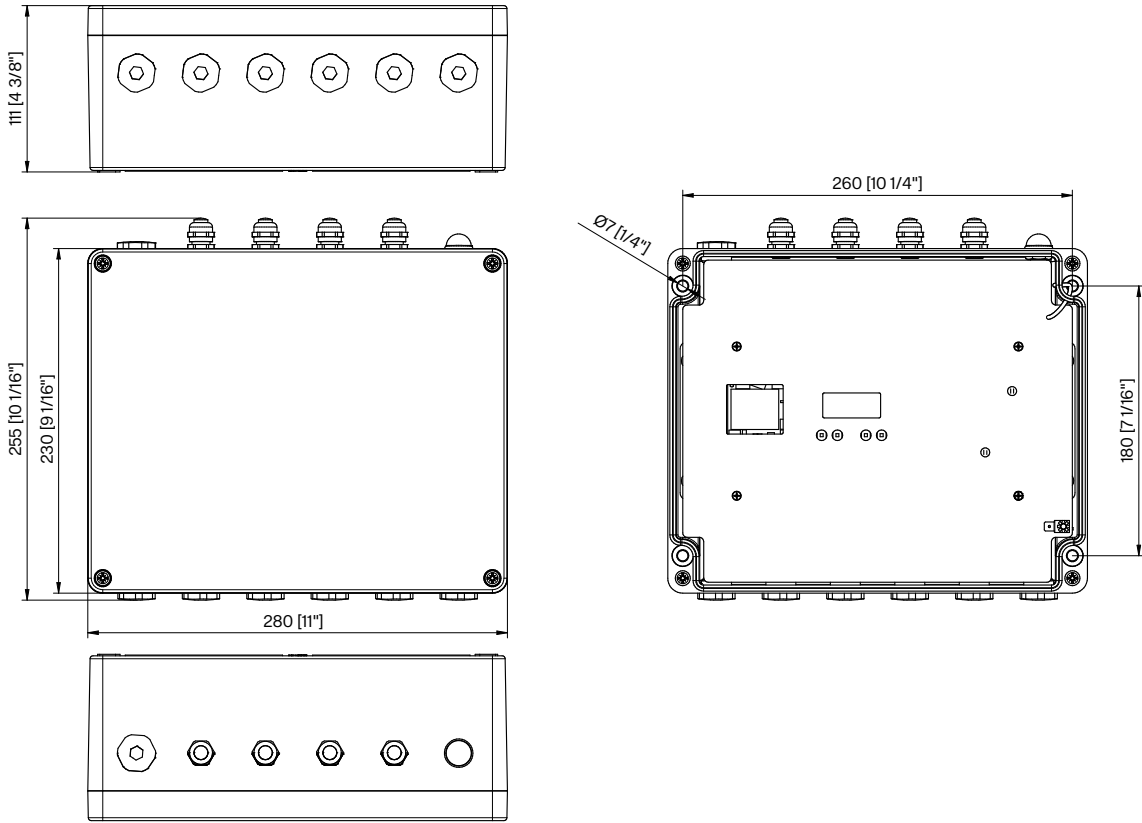

Electrical	Input Voltage	120–277 V AC 50 / 60 Hz
	Typical Power Consumption	5 W (self consumption)
	Max. Output Current	16 A
Control	Wireless DMX (Option)	Lumen Radio CRMX Technology
	Interface Protocol	USITT DMX512, RDM, ArtNet, MA Net, MA Net2, sACN, Kling-Net
	Operating Modes	DMX, Stand-alone
	Display	Two Row LCD and Control Buttons
Physical	Width × Height × Depth	280 × 230 × 111 mm (11.02 × 9.06 × 4.37 in.)
	Weight	4.4 kg / 9.7 lbs
	Number of LED Output zones	6
	Max. Load Per Device	144 pcs of Eminere 1 with 40 m total cable length @ 230 V
		78 pcs of Eminere 2 with 30 m total cable length @ 230 V
		53 pcs of Eminere 3 with 30 m total cable length @ 230 V
		40 pcs of Eminere 4 with 30 m total cable length @ 230 V
	DMX Modes	Total mode, Fixture mode, Pixel Mode, Output Mode
	Editable Programs	3 (up to 40 steps each)
	Eminere Output Connection	Leader Cable – Combo Power and Data
	Finish Options	Standard Colour – Graphite Black (RAL 9011) Silver (RAL 9006)
		Cost Option – Custom RAL Harsh Environment (RAL 9016, RAL 9011)
	Mounting Method	4 Mounting Holes
	Protection Factor	IP67, Suitable For Wet Location
	IK Rating	IK10
Cooling System	Convection	
Operating Temperature Range	-20 °C / +40 °C (-4 °F / +104 °F)	
Certification	Listings	ETL / cETL, CE, RoHS, UKCA

E-Box™ Remote

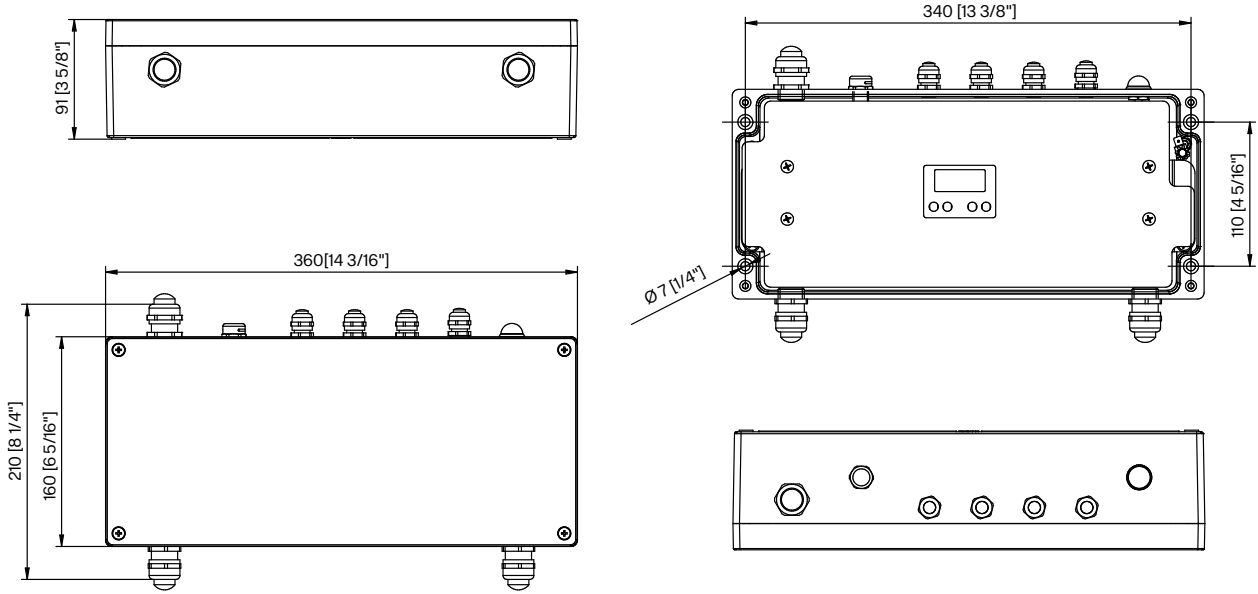

Electrical	Input Voltage	120–277 V AC 50 / 60 Hz
	Typical Power Consumption	520 W
Control	Wireless DMX (Option)	Lumen Radio CRMX Technology
	Interface Protocol	USITT DMX512 + RDM, ArtNet, MA Net, MA Net2, sACN, Kling-Net
	Operating Modes	Fixture Mode, Pixel Mode, Output Mode
	Display	Via Two Row LCD Display with Control Buttons or RDM communicator
	Control System	E-Box With Self Addressing Feature or Custom Setting Via LCD Display/RDM
	Power Supply	Integrated in E-Box Remote
	Connectivity	16 pcs of Eminere Remote 1 (50 m cable – total length) via 1 Output, 20 pcs in total for both Outputs (25 m cable – total length)
Physical	Width × Height × Depth	360 × 210 × 91 mm (14.17 × 8.27 × 3.58 in.)
	Weight	5.5 kg / 12.13 lbs
	Number of LED Output zones	2
	Max. Load Per Output	16 pcs of Eminere Remote 1 (50 m cable) via 1 Output
	Cable Length per E-Box	Max. 25 m (@ 20 pcs) Max. 50 m (@ 16 pcs) Max. 75 m (@ 13 pcs) Max. 100 m (@ 10 pcs)
	Housing	Die-Cast Aluminium Case
	Finish Options	Standard Colour – Graphite Black (RAL 9011) Silver (RAL 9006)
		Cost Option – Custom RAL Harsh Environment (RAL 9016, RAL 9011)
	Cables / Connections	Cable Grommet (stainless steel)
	Mounting Method	Surface Mount, 4 Mounting Holes
	Protection Factor	IP65 / Suitable For Wet Locations
	IK Rating	IK10
	Cooling System	Convection
	Operating Ambient Temperature	–20 °C / +40 °C (–4 °F / +104 °F)
Certification	Listings	ETL / cETL, CE, RoHS, UKCA

E-Box™ Remote Basic

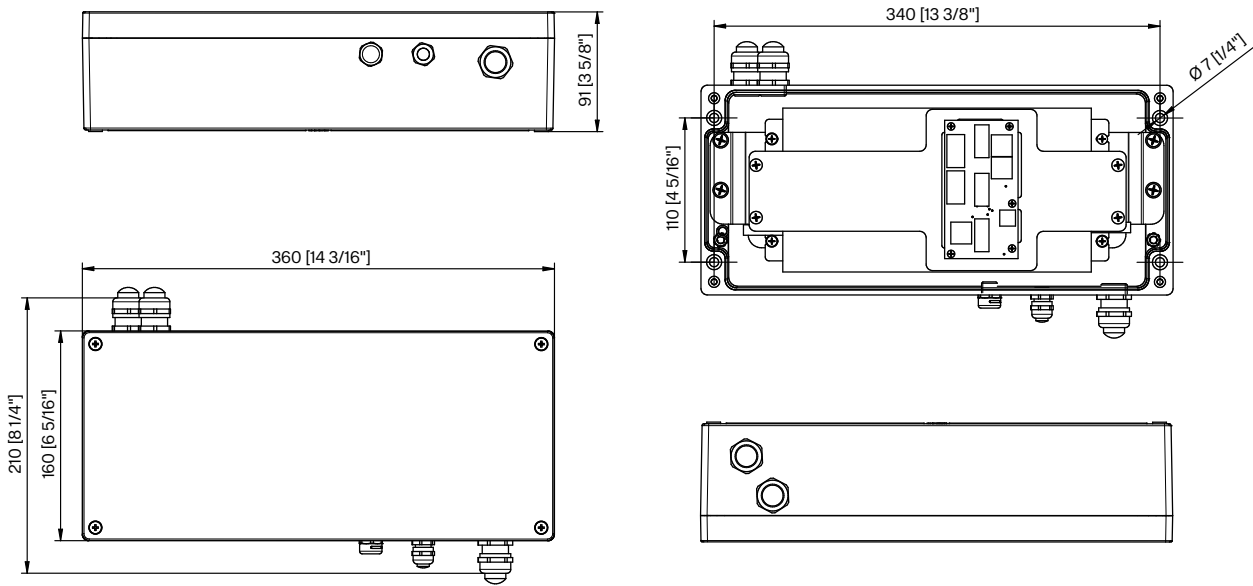

Electrical	Input Voltage	120–277 V AC 50 / 60 Hz
	Typical Power Consumption	520 W
Control	Power supply	Integrated
	Connectivity	16 pcs of Eminere Remote 1 (50 m cable – total length) via 1 Output, 20 pcs in total for both Outputs (25 m cable – total length)
Physical	Width × Height × Depth	360 × 210 × 91 mm (14.17 × 8.27 × 3.58 in.)
	Weight	5 kg / 11.02 lbs
	Number of LED Output zones	2
	Max. Load Per Output	16 pcs of Eminere Remote 1 (50 m cable) via 1 Output
	Cable Length per E-Box	Max. 25 m (@ 20 pcs) Max. 50 m (@ 16 pcs) Max. 75 m (@ 13 pcs) Max. 100 m (@ 10 pcs)
	Housing	Die-Cast Aluminium Case
	Finish Options	Standard Colour – Graphite Black (RAL 9011) Silver (RAL 9006)
		Cost Option – Custom RAL Harsh Environment (RAL 9016, RAL 9011)
	Cables / Connections	Cable Grommet (stainless steel)
	Mounting Method	Surface Mount, 4 Mounting Holes
	Protection Factor	IP65/ Suitable For Wet Locations
	IK Rating	IK10
	Cooling System	Convection
Operating Ambient Temperature	-20 °C / +40 °C (-4 °F / +104 °F)	
Certification	Listings	ETL / cETL, CE, RoHS, UKCA

SubDrive™ 1

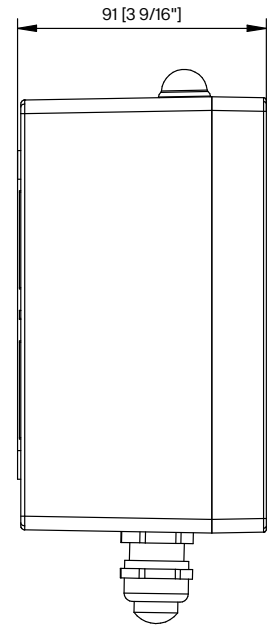
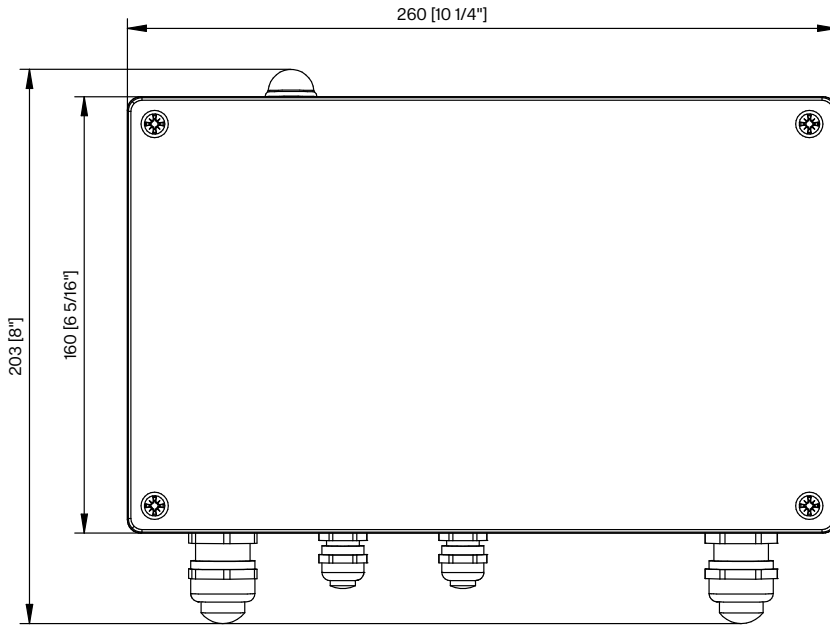

Electrical	Input Voltage	100–277 V AC 50 / 60 Hz
	Typical Power Consumption	Maximum mode (1 A) – 90 W @SubDrive 1
		Medium mode (700 mA) – 70 W @SubDrive 1
		Minimum mode (350 mA) – 35 W @SubDrive 1
	Max. Output Current	Maximum mode (1000 mA) Medium mode (700 mA) Minimum mode (350 mA)
LED Output Voltage	24 V DC	
<hr/>		
Control	Display	4 – Digit LED, 4 buttons
	Wireless DMX (Option)	Lumen Radio CRMX Technology
	Interface Protocol	USITT DMX512, RDM
	Control System	Third Party DMX Controllers
	Operating Modes	DMX, Master/Slave, Stand-alone
	Programs/ Functions/ Features	Editable Program: 3 (up to 40 steps each)
	Settings / Addressing	Via RDM communicator or ROBE Universal Interface (RUNIT)
	Width × Height × Depth	260 × 160 × 91 mm (10.24 × 6.30 × 3.58 in.)
	Weight	2.91 kg 6.42 lbs
	Number of LED Output zones	1
	Max. Load Per Zone	1 × ArcSource Submersible II
	Total Load	1 × ArcSource Submersible II
	Max Cable Length	100 m (Minimum mode) 50 m (Medium mode) 25 m (Maximum mode)
	LED Output Connection	Terminal Block
	DMX Connection	Terminal Block
	Power Connection	Terminal Block
	Finish Options	Standard Colour – Graphite Black (RAL 9011) Silver (RAL 9006)
		Cost Option – Custom RAL Harsh Environment (RAL 9016, RAL 9011)
	Mounting Method	4 Mounting Holes
	Protection Factor	IP67 / Suitable For Wet Location
	IK Rating	IK10
	Cooling System	Convection
	Operating Temperature Range	–20 °C / +40 °C (–4 °F / +104 °F)
<hr/>		
Certification	Listings	ETL / cETL, CE, RoHS, UKCA
<hr/>		
Accessories	for SubDrive 1/4	Reducing Seal for Cable Diameter 4–8 mm (1 pcs Included)

SubDrive™ 4

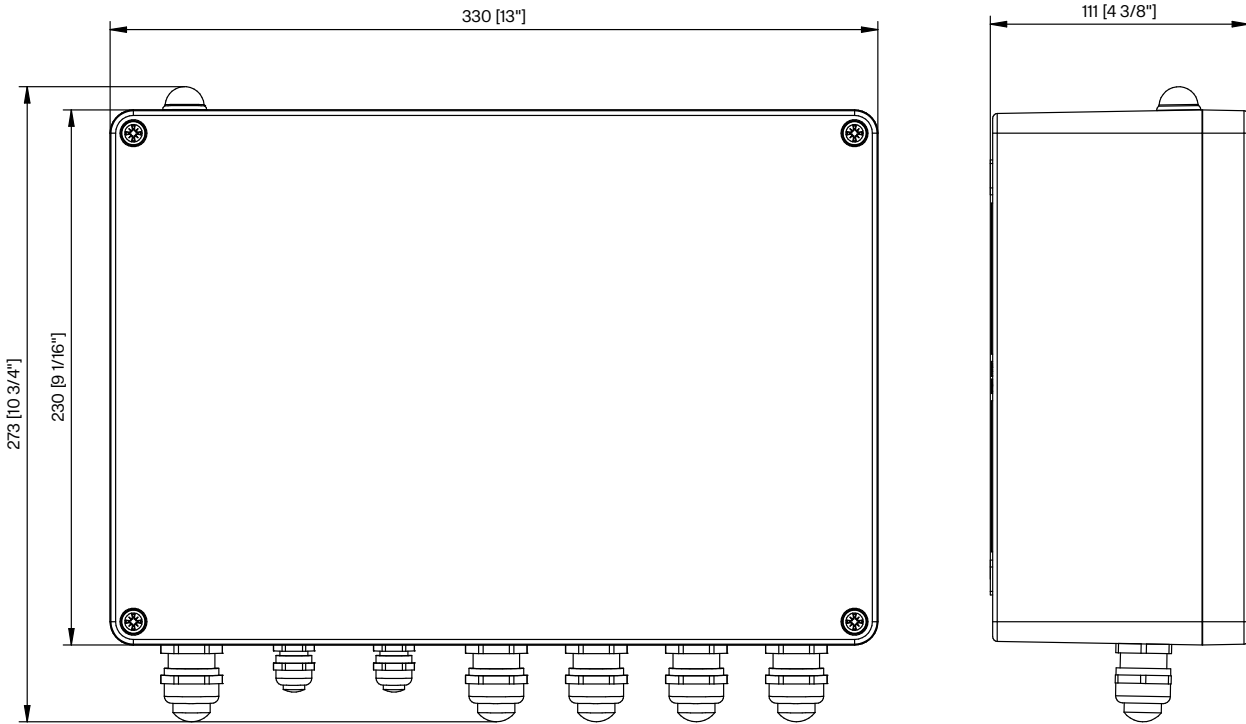

Electrical	Input Voltage	100–277 V AC 50 / 60 Hz
	Typical Power Consumption	Maximum mode (1 A) – 440 W @SubDrive 4
		Medium mode (700 mA) – 350 W @SubDrive 4
		Minimum mode (350 mA) – 200 W @SubDrive 4
	Max. Output Current	Maximum mode (1000 mA) Medium mode (700 mA) Minimum mode (350 mA)
LED Output Voltage	24 V DC	
<hr/>		
Control	Display	4 – Digit LED, 4 buttons
	Wireless DMX (Option)	Lumen Radio CRMX Technology
	Interface Protocol	USITT DMX512, RDM
	Control System	Third Party DMX Controllers
	Operating Modes	DMX, Master/Slave, Stand-alone
	Programs/ Functions/ Features	Editable Program: 3 (up to 40 steps each)
	Settings / Addressing	Via RDM communicator or ROBE Universal Interface (RUNIT)
	Width × Height × Depth	330 × 230 × 111 mm (12.99 × 9.05 × 4.37 in.)
	Weight	7.23 kg 15.94 lbs
	Number of LED Output zones	4
	Max. Load Per Zone	1 × ArcSource Submersible II
	Total Load	4 × ArcSource Submersible II
	Max Cable Length	100 m (Minimum mode) 50 m (Medium mode) 25 m (Maximum mode)
	LED Output Connection	Terminal Block
	DMX Connection	Terminal Block
	Power Connection	Terminal Block
	Finish Options	Standard Colour – Graphite Black (RAL 9011) Silver (RAL 9006)
		Cost Option – Custom RAL Harsh Environment (RAL 9016, RAL 9011)
	Mounting Method	4 Mounting Holes
	Protection Factor	IP66 / Suitable For Wet Location
	IK Rating	IK10
	Cooling System	Convection
	Operating Temperature Range	–20 °C / +40 °C (–4 °F / +104 °F)
<hr/>		
Certification	Listings	ETL / cETL, CE, RoHS, UKCA
<hr/>		
Accessories	for SubDrive 1/4	Reducing Seal for Cable Diameter 4–8 mm (1 pcs Included)

ArcPower™ Unit



Wall Mount

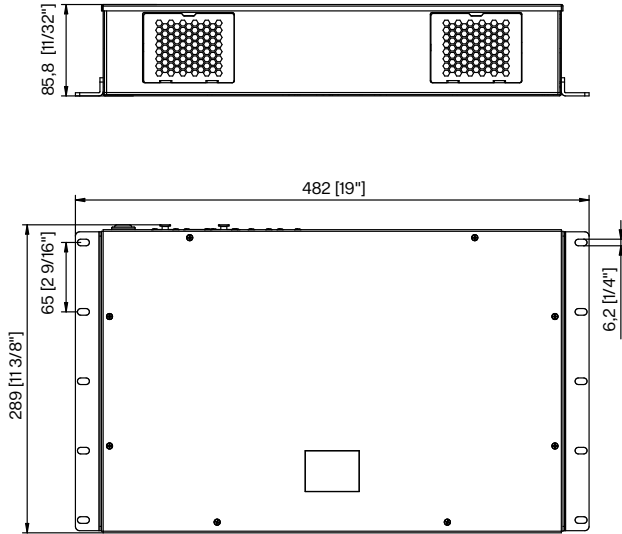

Rack Mount

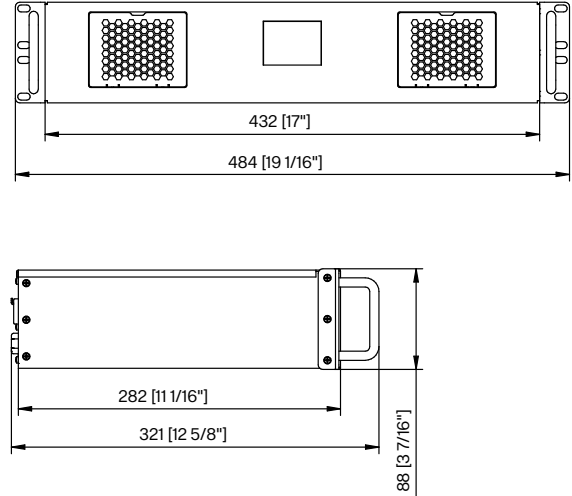

Electrical	Input Voltage	100–240 V AC 50 / 60 Hz (CE) 100–277 V AC 50 / 60 Hz (US)
	Typical Power Consumption	1400 W ±10 % (CE), 1000 W (US 48 V), 700 W ±10 % (US 28 V) LV: 700 W ±10 %
	Max. Output Current	350 mA, 700 mA, custom 100 mA – 1000 mA Per Channel
	Max. Output Voltage	48 V (CE), 28 V, 48 V (US)
	Control	Interface Protocol
	Operating Modes	DMX, Master/Slave, Stand-alone
	Display	Graphic Touch Screen (50 × 40 mm / 1.97 × 1.57 in.)
	Programs / Functions / Features	Editable Program: 3 (up to 40 steps each)
Physical	Width × Height × Depth	Rack Mount: 484 (432) × 88 × 321 (282) mm (19.05 (17) × 3.54 × 12.64 (11.10) in.) Wall Mount: 482 (432) × 86 × 289 mm (18.97 (17) × 3.38 × 11.37 in.)
	Weight	6.5 kg / 14.3 lbs
	Number of LED Output zones	8 (28 V: 6)
	Typical Max. Load Per Channel (48 V)	(CE): 12 × ArcSource Outdoor 4MC (USs/48 V): 12 × ArcSource Outdoor 4MC
	LED Output	RJ45, Terminal Block (8-pin)
	DMX Connection In/Out	Terminal Block, 2 × 5-pin XLR
	Ethernet Connection	RJ45
	Other	Trigger Input, Max. 5 V DC (terminal block) 12 V DC Output for DMX Controller
	Mounting Method	Wall Mount or Rack Mount
	Finish Options	Standard Colour – Graphite Black (RAL 9011) Silver (RAL 9006) Cost Option – Custom RAL
	Protection Factor	IP20 / Suitable For Dry Locations
	Cooling System	Fan Cooled
	Operating Ambient Temperature	0 °C / +40 °C (+32 °F / +104 °F)
	Operating Temperature	+75 °C @ Ambient +50 °C (+167 °F @ Ambient +122 °F)
	Total Heat Dissipation	4770 BTU/h (calculated)
	Operating Temperature Range	-10 °C / +40 °C (14 °F / +104 °F)
	Certification	Listings
Accessories		8 × Terminal Block M (included)

ArcPower™ Unit Pixel



Wall Mount

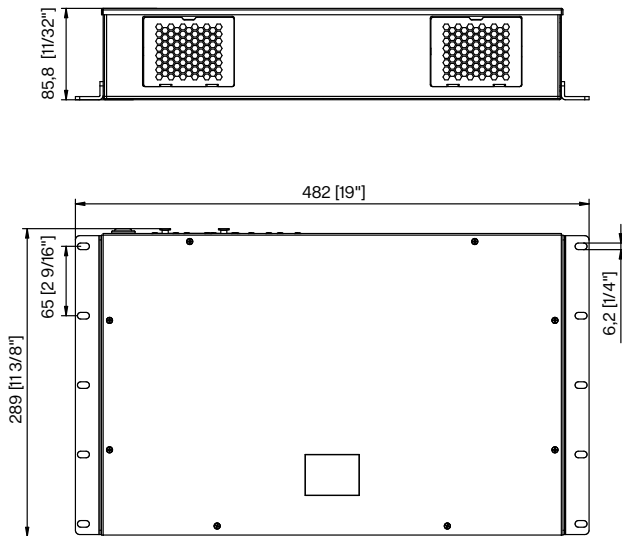

Rack Mount

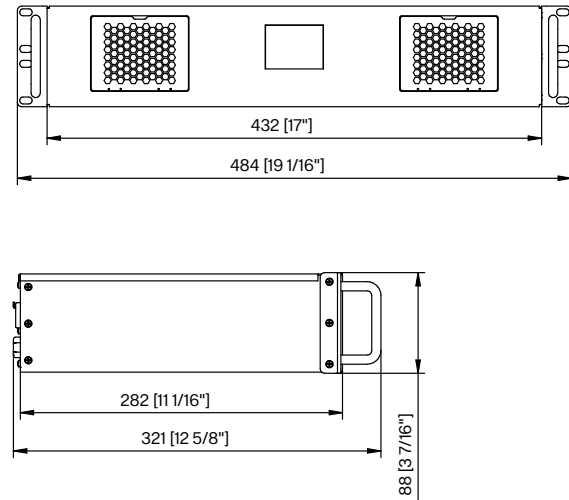

Electrical	Input Voltage	100–240 V AC 50 / 60 Hz (CE) 100–277 V AC 50 / 60 Hz (US)	
	Typical Power Consumption	1400 W ±10 % (CE), 1000 W (US 48 V), 700 W ±10 % (US 28 V)	
	Max. Output Voltage	48 V (CE), 28 V, 48 V (US)	
	<hr/>		
Control	Interface Protocol	USITT DMX512, RDM, ArtNet, MANet, MANet 2, sACN	
	Operating Modes	DMX, Master/Slave, Stand-alone	
	Display	Graphic Touch Screen (50 × 40 mm / 1.97 × 1.57 in)	
	Programs / Functions / Features	Editable Program: 3 (up to 40 steps each)	
<hr/>			
Physical	Width × Height × Depth	Rack Mount: 484 (432) × 88 × 321 (282) mm (19.05 (17) × 3.54 × 12.64 (11.10) in.) Wall Mount: 482 (432) × 86 × 289 mm (18.97 (17) × 3.38 × 11.37 in.)	
	Weight	6.5 kg /14.3 lbs	
	Number of LED Output zones	8 (28 V: 6)	
	Typical Max. Load Per Channel (48 V)	(CE): 35 × ArcSource Outdoor 4MC Pixel (US / 48 V): 16 × ArcSource Outdoor 4MC Pixel	
	LED Output	Terminal Block (3-pin and 5-pin)	
	DMX Connection In/Out	Terminal Block, 2 × 5-pin XLR	
	Ethernet Connection	RJ45	
	Other	Trigger Input, Max. 5 V DC (terminal block) 12 V DC Output for DMX Controller	
	Mounting Method	Wall Mount or Rack Mount	
	Finish Options	Standard Colour – Graphite Black (RAL 9011) Silver (RAL 9006) Cost Option – Custom RAL	
	Protection Factor	IP20 / Suitable For Dry Locations	
	Cooling System	Fan Cooled	
	Operating Ambient Temperature	0 °C / +40 °C (+32 °F / +104 °F)	
	Operating Temperature	+75 °C @ Ambient +50 °C (+167 °F @ Ambient +122 °F)	
	Total Heat Dissipation	4770 BTU/h (calculated)	
	Operating Temperature Range	-10 °C / +40 °C (14 °F / +104 °F)	
	<hr/>		
	Certification	Listings	ETL / cETL, CE, RoHS, UKCA
	<hr/>		
Accessories		Terminal Block, 2 × 5-pin XLR 8 × Terminal Block M (included)	

Ambiane™ Power Rack

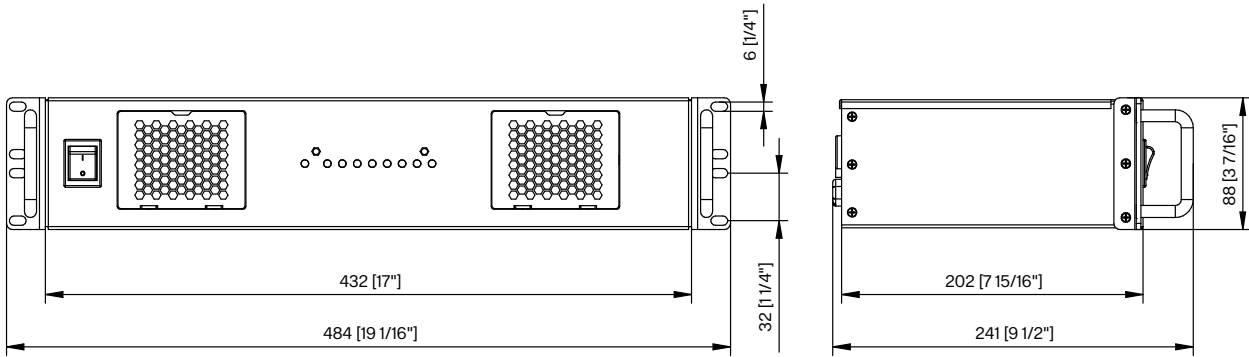

Electrical	Input Voltage	CE	100–240 V AC 50/60 Hz
		US	100–277 V AC 50/60 Hz
	Maximal Power Consumption	1350 W	
	Output Voltage	48 V DC	
	Outputs	8	
	Max. Load per output	200 W	
	Max. Total Load	1200 W	
	Power Supply	Integrated	
Physical	Length × Height × Depth	484 (432) × 88 × 241 (202) mm / 19.05 (17) × 3.46 × 9.48 (7.95) in.	
	Weight	5.4 kg 11.9 lbs	
	Housing	Rack Standard – 2U or Wall Mounted Brackets	
	Finish Options	Standard Colour – Graphite Black (RAL 9011) Silver (RAL9006)	
		Cost Option – Custom RAL	
	Cables / Connections	8 × Terminal Block (DC power Out)	
		1 × Main Power Cord (w/plug; CE/US)	
	Mounting Method	Designed to Rack Box Installation	
	Protection Factor	IP20 / Dry locations only	
	Cooling System	Fan Cooled	
Operating Ambient Temperature	–20 °C / +40 °C (–4 °F / +104 °F)		
Certification	Listings	ETL / cETL, CE, RoHS, UKCA	

ArcPixel™ Power

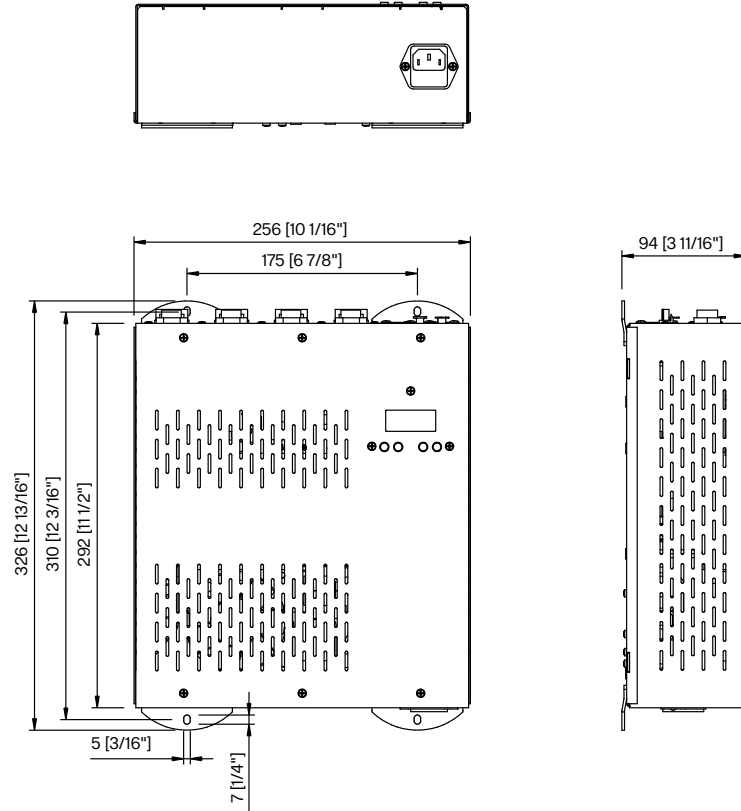

Electrical	Input Voltage	100–240 V AC 50 / 60 Hz (CE)
	Typical Power Consumption	650 W ±10 %, US version 420 W ±10%
Control	Interface Protocol	USITT DMX512, RDM, ArtNet
	Display	Two Row LCD Display With Control Buttons
Physical	Width × Height × Depth	326 × 256 × 94 mm (12.8 × 10.1 × 3.7 in.)
	Weight	3.4 kg / 7.5 lbs
	Number of LED Output zones	4 (Art-Net), 3 (DMX)
	Max. Load Per Zone	ArcSource Outdoor 4MC Pixel: CE – 35 (typically 25), US – 16
		ArcPix: CE – 100, US – 65
	Total Load	ArcSource Outdoor 4MC Pixel: CE – 100, US – 64 (ArtNet)
		ArcPix: CE – 400, US – 260 (ArtNet)
	Max. Cable Length	ASO 4MC Pixel: CE – 100 m @ 25 units per output (or 65 m @ 35 units)
		ASO 4MC Pixel: US – 100 m @ 16 units per output
		ArcPix: CE – 100 m @ 100 units per output
		ArcPix: US – 100 m @ 64 units per output
	LED Output Connection	Chogori IP67 connector, 3 – pin (female) Sauro CGF 050 M5
	DMX Connection In/Out	3 – pin Male / Female XLR (In and Out)
	Art-Net Connection	RJ45
	Power Connection	Panel connector IEC C14 (socket)
	Mounting Method	4 Mounting Holes
	Finish Options	Standard Colour – Graphite Black (RAL 9011), Silver (RAL 9006)
Cost Option – Custom RAL		
Protection Factor	IP20 / Suitable For Dry Locations	
Cooling System	Convection	
Operating Temperature Range	–10 °C / +40 °C (14 °F / +104 °F)	
Certification	Listings	ETL / cETL, CE, RoHS, UKCA
Accessories		Power cord IEC C13 (included)
		Screw terminal board Sauro CGM 050 M5 (4pcs included)

ArcControl™ DU

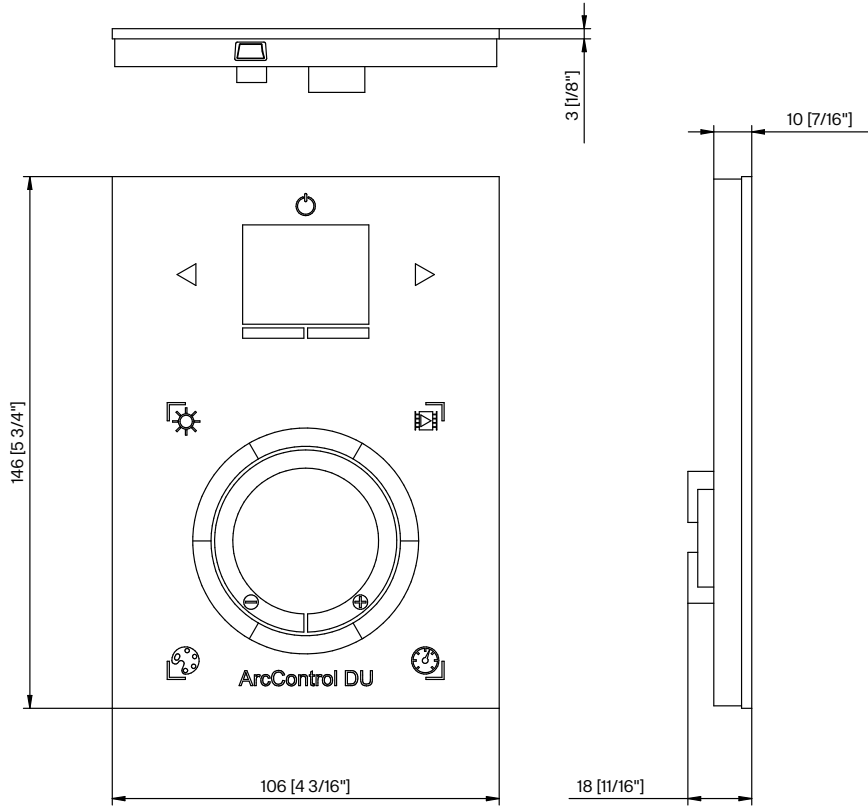

Electrical	Input Voltage	100–277 V AC 50 / 60 Hz
Control	Interface Protocol	DMX512 (x2)
	Display	Graphical Colour Display, Touch Sensitive Buttons
Physical	Width × Height × Depth	146 × 106 × 10 mm (5.75 × 4.17 × 0.39 in.)
	Weight	0.247 kg / 0.55 lbs
Specification	PC requirement	Windows, Mac
	Software	On USB
	Memory	MicroSD Card
	Face Colour	Black, White
	Mounting	Wall Mount
	Connections	8 Dry Contact Ports, Micro USB, Ethernet, RS232, Clock
	DMX Channels	1024 Max.
	Built-In Programs	Up To 500 Scenes, 10 Zones
	Compatibility	Compatible With Any DMX Fixture or DMX LED Driver
	Effect	Colour Changing Effects, Specific Colours, Clock And Calendar
	Protection Factor	IP20
	Operating Temperature Range	32 °F / +113 °F (0 °C / +45 °C)
Certification	Listings	ETL / cETL, CE, RoHS, UKCA
Accessories		6 V AC / DC Power Supply

RUNIT WTX™

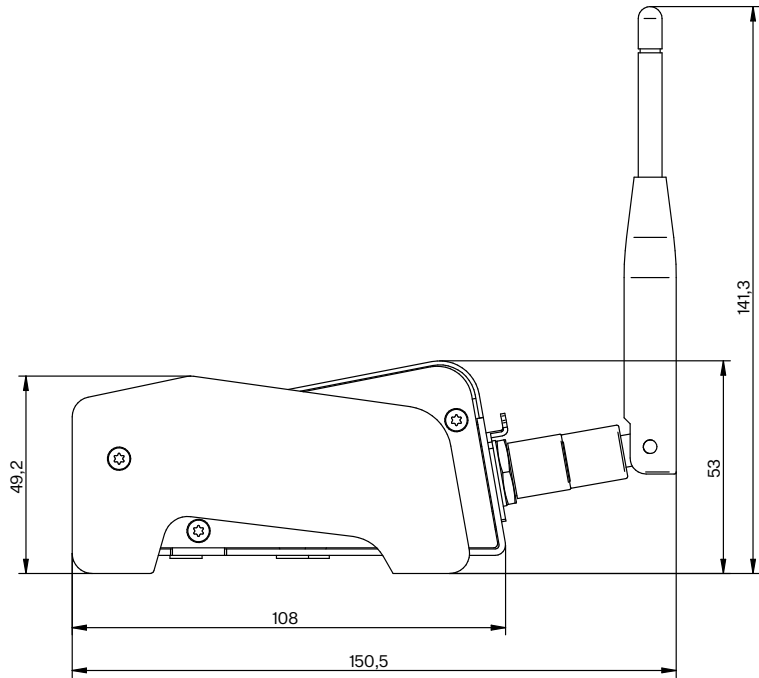
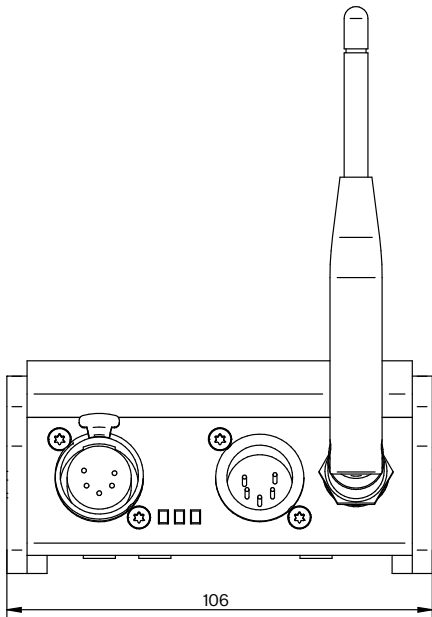

Electrical	Power	Powered from USB Galvanic isolation of 1 kV between DMX Input and USB (DMX Output and USB)
	Supported Operating Systems	Windows 10, 8.1, 8, 7, ME, 2000, XP, Vista, Server 2003 MacOS X v10.5 and above Linux
Connection	DMX data in/out	Locking 5-pin XLR
	USB	2.0 (series B)
Physical	Width × Height × Depth	106 × 141 × 150.5 mm (4.2 × 5.6 × 5.9 in.)
	Weight	0.4 kg / 0.88 lbs
	Housing	Rugged aluminium housing
Functions		USB/DMX converter
		Provides fixture software updates
		Brings RDM communication protocol into DMX 512 control systems
		Wireless DMX+RDM
	RDM-network software allows:	Fixture Status Monitoring
		Fixture Personality Setting
	AutoPatch	
Certification	Listings	RoHS, UKCA

www.anolislighting.com

info@anolis.eu
+420 571 751 500

Head Office

Anolis
Hážovice 2090
756 61 Rožnov pod Radhoštěm
Czech Republic

Factory

Anolis
Palackého 416
757 01 Valašské Meziříčí
Czech Republic

Graphics, composition
KNOW HOW solutions s.r.o.

Print shop
GRASPO CZ, a.s.

Issue
EN 06/2022

© June 2022 Anolis
All specifications subject to change without notice.

