

EMINERE™ INGROUND 1 / 2 / 4

Eminere Inground is a robust luminaire designed to be installed into the ground. A stainless steel installation sleeve provides rust protection as well as "armour" for the Eminere fixture itself. Overall, Eminere Inground comes with an IP67 protection factor, standard or Anti-skid glass, and as always, perfect colour mixing. With $\pm 15^\circ$ tilt adjustment, precision optics with wide range of beam angles and colour variants, in-ground version of the Eminere luminaire is great choice for an exterior applications such as flood lighting, wall grazing, wall washing and accent lighting.



KEY FEATURES

Application

Anti-skid glass option for pedestrian areas application. Easy to install into soft and hard ground.

Light Source

Full spectral LEDs selection with custom option on request. Output up to 2.019 lm for Eminere Inground 2 RGBW. Long LED lifetime over 90,000 hrs. Manually adjustable tilt $\pm 15^\circ$ for fine adjustment of light beam.

Durability

High durability with ingress factor of IP67 and walkover housing made from stainless steel with welded support for highest durability requirements.

COLOURS



CONTROL & PROTOCOLS



STANDARD & SPECIFICATION

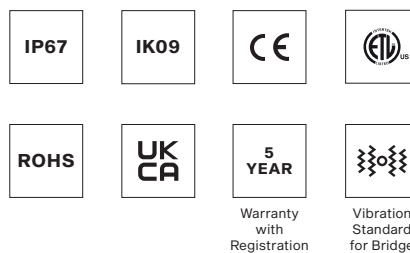

FINISH OPTIONS



COLOUR TEMPERATURE

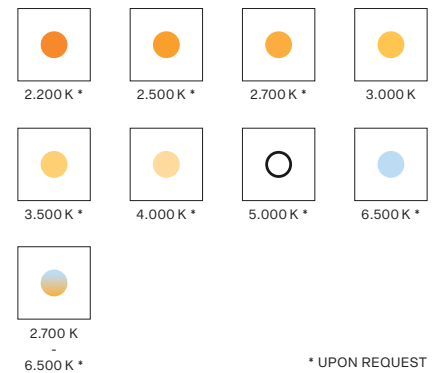

OPTIC OPTIONS

SYMMETRICAL

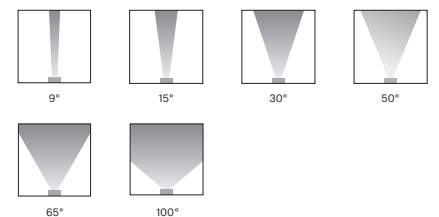

BI-SYMMETRICAL

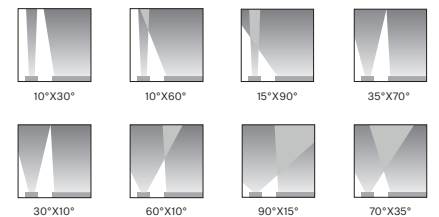

ASYMMETRICAL



EMINERE INGROUND SPECIFICATION

ELECTRICAL	Input Voltage	120 - 277 V AC 50/60 Hz		
	Typical Power Consumption	Eminere Inground 1: 30 W	Eminere Inground 2: 50 W	Eminere Inground 4: 90 W
OPTICAL	Light Source	12, 24, 48 x High Power Single Chip LEDs		
	Colour Variants	RGBW (W - 6.500 K)	RGBA	PW (W - 3.000 K)
		Variants On Request (TW (2700 - 6500 K) 2500 K 2700 K 3500 K 4000 K 5000 K 6500 K)		
	Beam Angle	Symmetrical	Clear Glass: 9° 15° 30° 50° 100° Anti-Skid: 18° 22° 35° 50° 65° 100°	
		Bi-symmetrical	Clear Glass: 10° x 30° 10° x 60° 15° x 90° 35° x 70° Anti-Skid: 20° x 35° 20° x 65° 20° x 90° 40° x 70°	
		Asymmetrical:	Wallwasher Wide Wallwasher	
	Lumen Output Delivered	Eminere Inground 1	1.008 lm, RGBW @ 9° (Clear Glass) PRELIMINARY 1.010 lm, RGBW @ 18° (Anti-Skid) PRELIMINARY	
Eminere Inground 2		2.019 lm, RGBW @ 9° (Clear Glass) 2.021 lm, RGBW @ 18° (Anti-Skid)		
Eminere Inground 4		4.038 lm, RGBW @ 9° (Clear Glass) 4.042 lm, RGBW @ 18° (Anti-Skid)		
Projected Lumen Maintenance	L90B10 >90.000 hrs, Ta = 25°C / 77°F			
CONTROL	Interface Protocol	Via E-Box range or Wireless DMX		
	E-Box Control Protocols	USITT DMX512, RDM, ArtNet, MA Net, MA Net2, sACN, Kling-Net		
	Wireless DMX (Option)	Lumen Radio CRMX Technology		
	Operating Modes	Pixel (12 LEDs/300mm) or Fixture mode		
	Setting / Addressing	Via Two Row LCD Display with Control Buttons or RDM communicator		
	Power Supply	Integrated		
	Connectivity	E-box Lite	Max. 32 pcs of Eminere Inground 1 / 2 / 4	
PHYSICAL	Width x Height x Length	Eminere Inground 1 / 2 / 4:	186 x 230 x 407 / 707 / 1307 mm (7.32 x 9.05 x 16.02 / 27.83 / 51.46 in.)	
		12.5 kg / 27.65 lbs	(6.8 kg / 15 lbs Eminere Inground 1 Fixture , (6.6 kg / 14.5 lbs Install. Sleeve)	
	Weight	23.6 kg / 52 lbs	(12.2 kg / 26 lbs Eminere Inground 2 Fixture , 11.4 kg / 25 lbs Install. Sleeve)	
		43.85 kg / 96.67 lbs	(22.65 kg / 49.93 lbs Eminere Inground 4 Fixture , 21.2 kg / 46.74 lbs Install. Sleeve)	
	Housing	High Pressure Extruded Aluminium Body End Caps - Die-Cast Aluminium Tempered Glass Anti-Skid (Option) Stainless Steel Instalation sleeve for pre-instalation		
	Finish Options	Stainless Steel Flange Housing Standard Colour - Graphite Black (RAL 9011)		
	Connections	Junction Box		
	Mounting Method	Inground mount		
	Adjustability	+/- 15° after instalation		
	Protection Factor	IP67 / Suitable For Wet Locations		
IK Rating	IK09			
Max. Static Load	Standard Tempered Glass: 45kN	Anti-Skid Tempered Glass: 23kN		
Cooling System	Convection			
Operating Ambient Temperature	-20 °C / +40 °C (-4 °F / +104 °F)			
Operating Temperature	+80 °C @ Ambient +40 °C (+176 °F @ Ambient +104 °F)			
CERTIFICATION	Listings	ETL / cETL, CE, RoHS, UKCA		
	Anti - Skid Glass Certification	UNE ENV12633 (Class 3), DIN 51130 (R-12), DIN 51097 (Class B), ASTM C 1028-07 (DRY: ≥ 0,7, WET: ≥ 0,6), EN101:91 MOHS (4-Point scale)		
ACCESSORIES	Mounting	Eminere Inground Mounting Sleeve Eminere Inground Cover Plate Continuous (always packed with 1x Cover Plate Middle) Eminere Inground Cover Plate End		
	Cables	Cable CE WCA Cable US WCA		

DIMENSIONS

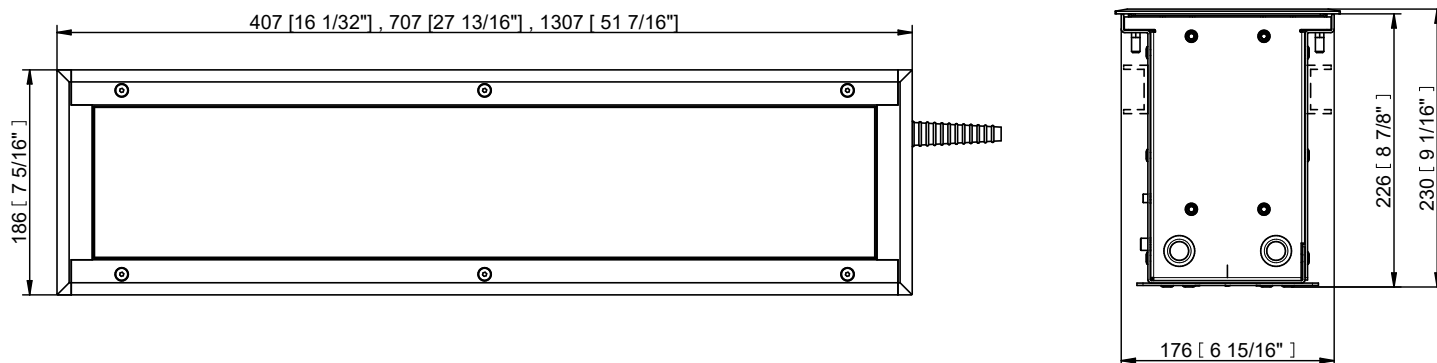

PHOTOMETRIC OVERVIEW

Based on RGBCW (CLEAR GLASS) version, all leds @ full

Lumen Output (lm)

	EMINERE INGROUND 2	EMINERE INGROUND 4
9°	2 019	4 038
15°	1 721	3 442
30°	1 841	3 682
50°	1 829	3 658
65°	1 830	3 660
100°	1 696	3 392
10° x 30°, 30° x 10°	1 816	3 632
10° x 60°, 60° x 10°	1 649	3 298
15° x 90°, 90° x 15°	1 707	3 414
35° x 70°, 70° x 35°	1 830	3 660
WallWasher	1 676	3 352
Wide WallWasher	1 388	2 776

Based on RGBCW (ANTI-SKID GLASS) version, all leds @ full

Lumen Output (lm)

	EMINERE INGROUND 2	EMINERE INGROUND 4
18°	2 021	4 042
22°	1 861	3 722
35°	1 802	3 604
50°	1 773	3 546
65°	1 708	3 416
100°	1 568	3 136
20° x 35°, 35° x 20°	1 843	3 686
20° x 65°, 65° x 20°	1 769	3 538
20° x 90°, 90° x 20°	1 752	3 504
40° x 70°, 70° x 40°	1 786	3 572
WallWasher	1 664	3 328
Wide WallWasher	1 301	2 602

COLOUR MIXING PRINTS

STAND ALONE Specially designed glass printing to achieve optimal colour mixing and intensity distribution.

HEAD2HEAD Fixtures without special end glass print installed right next to each other create absolutely perfect colour and intensity overlap.

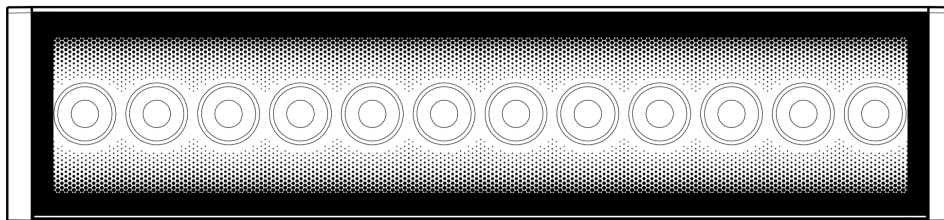

HEAD2HEAD

SYMMETRICAL

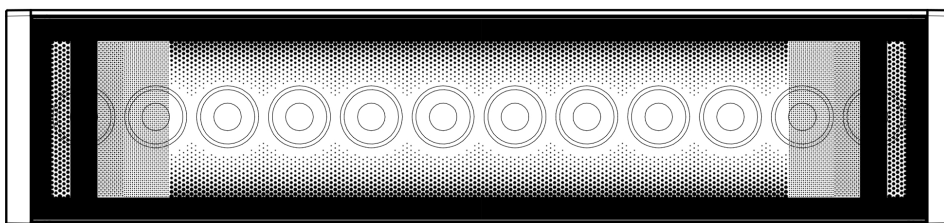

STAND ALONE

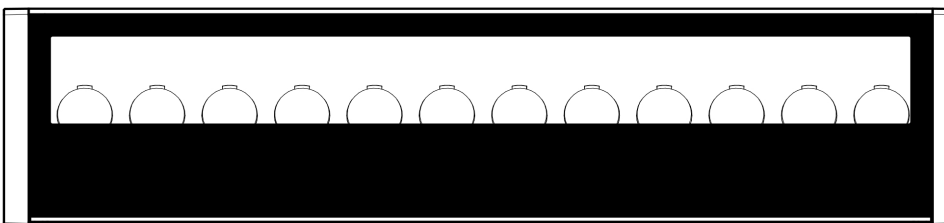

HEAD2HEAD

WALLWASHER

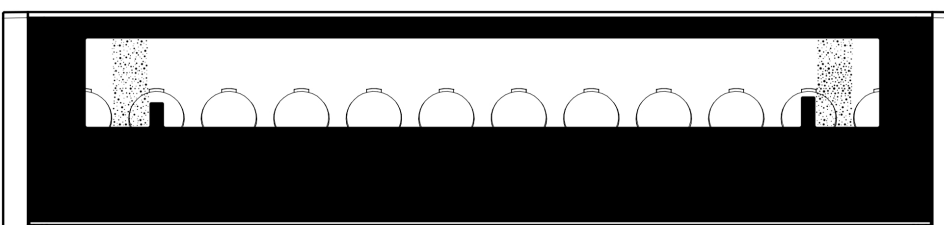

STAND ALONE

Note: Applies for RGBW, RGBA versions. Pure white and Tunable white versions are always without the end print (no matter on their position to other fixture).

E-BOX SPECIFICATION

ELECTRICAL	Input Voltage	120 – 277 V AC 50/60 Hz		
	Wireless DMX (Option)	Lumen Radio CRMX Technology		
	Interface Protocol	E-box Lite: USITT DMX512, RDM		
		E-box Daisy / Star: USITT DMX512, RDM, ArtNet, MA Net, MA Net2, sACN, Kling-Net		
CONTROL	Operating Modes	E-box Lite / Daisy: Fixture Mode, Pixel Mode, Output Mode		
		E-Box Star: Total Mode, Fixture Mode, Pixel Mode, Output Mode		
PHYSICAL	Display	Via Two Row LCD Display with Control Buttons or RDM communicator		
	Control System	E-box With Self Addressing Feature or Custom Setting Via LCD Display/RDM		
	Power Supply	Integrated		
	Connectivity	E-box Lite	144 of Eminere 1 (@ 230 V and 40m cable) via 1 Output	
		E-box Daisy	144 of Eminere 1 (@ 230 V and 40m cable) via 1 Output	
		E-box Star	144 of Eminere 1 (@ 230 V and 40m cable) via 6 Outputs	
	Length x Width x Height	E-box Lite	220 x 120 x 81 mm (8.66 x 4.72 x 3.18 in.)	
		E-box Daisy	260 x 160 x 91 mm (10.24 x 6.30 x 3.58 in.)	
		E-box Star	280 x 230 x 111 mm (11.02 x 9.06 x 4.37 in.)	
	Weight	1.67 kg 3.85 lbs	2.78 kg 6.13 lbs	4.4 kg 9.7 lbs
Housing	Die-Cast Aluminium Case			
Finish Options	Standard Colour - Graphite Black (RAL 9011) Silver (RAL 9006)			
	Cost Option - Custom RAL Harsh Environment (RAL 9016, RAL 9011)			
Cables / Connections	Cable Grommet (stainless steel)			
Mounting Method	Surface Mount , 4 Mounting Holes			
Protection Factor	IP67 / Suitable For Wet Locations			
IK Rating	IK10			
Cooling System	Convection			
Operating Ambient Temperature	-20 °C / +40 °C (-4 °F / +104 °F)			
CERTIFICATION	Listings	ETL / cETL, CE, RoHS, UKCA		

COMPARISON

	E-BOX LITE	E-BOX DAISY	E-BOX STAR
Power input	1	1	1
Fixture Output	1	1	6
Total load (current)	16A	16A	16A
DMX control	YES	YES	YES
RDM	YES	YES	YES
Art-Net	NO	YES	YES
Ethernet switch	NO	YES	YES
Kling-Net	NO	YES	YES
sACN	NO	YES	YES
MA Net, MA Net2	NO	YES	YES

E-BOX DIMENSIONS

E-BOX LITE

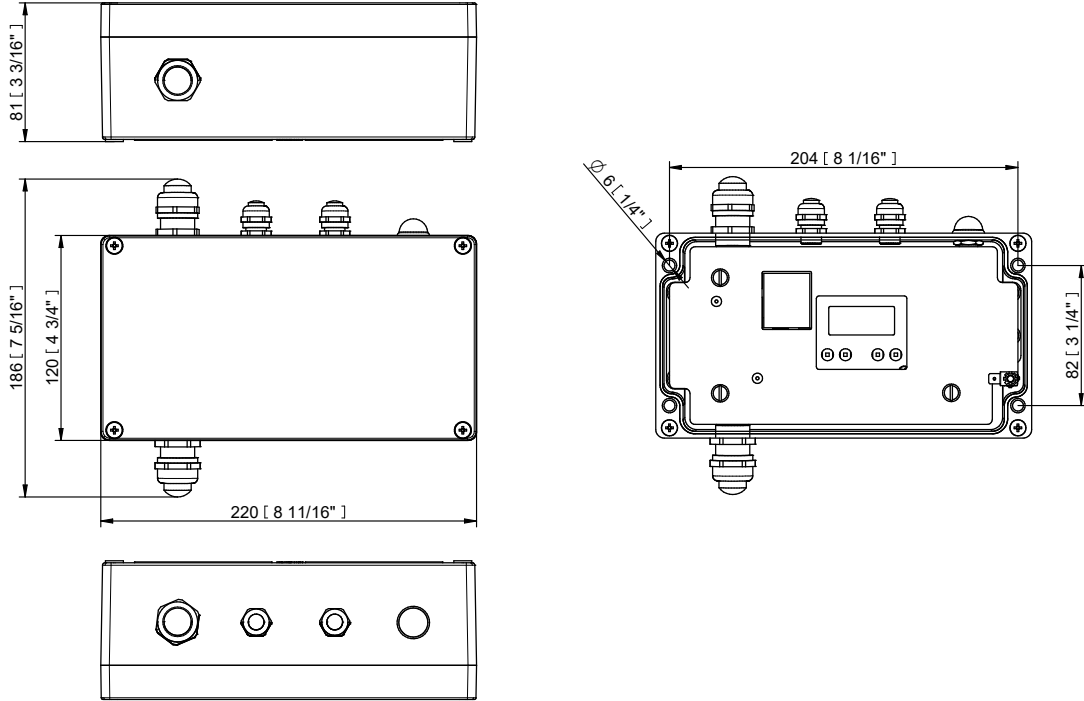

E-BOX DAISY

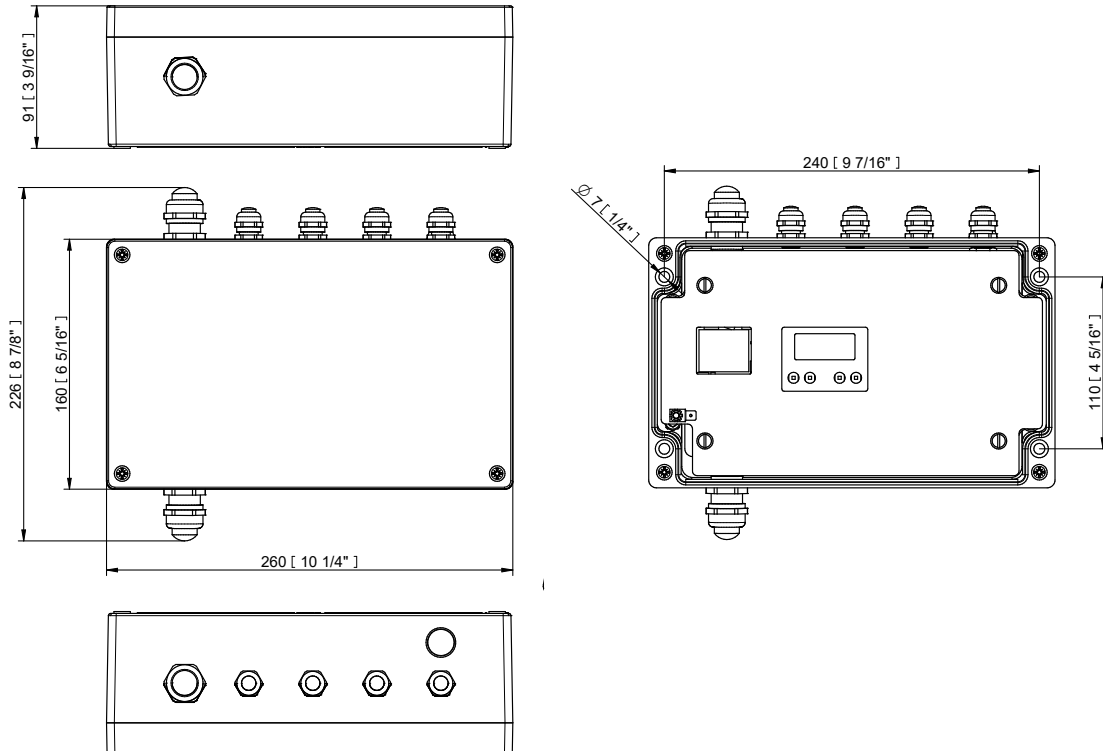

E-BOX STAR

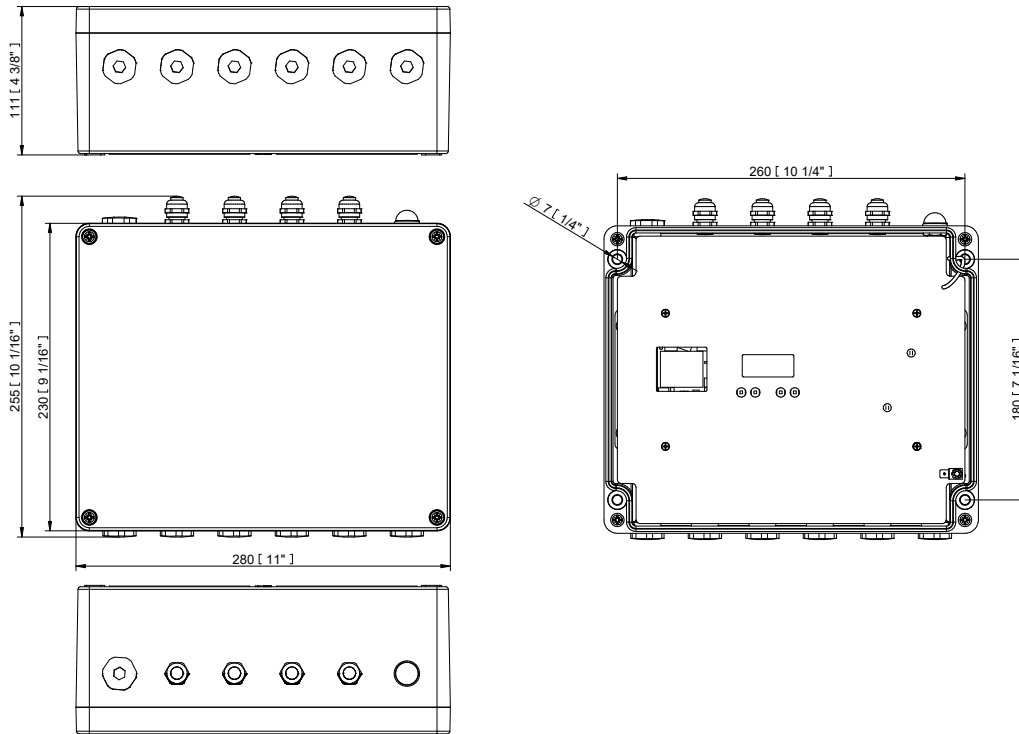

CONNECTIVITY

Following table shows maximum connected Emineres on each output of E-Box with respect of cable length.

	Cable length (m)	Voltage (V)			
		120	190	230	277
EMINERE INGROUND 2	10	32	32	32	32
	20	32	32	32	32
	30	28	32	32	32
	50	17	32	32	32
	70	12	31	32	32
	100	9	21	32	32

	Cable length (m)	Voltage (V)			
		120	190	230	277
EMINERE INGROUND 4	10	21	32	32	32
	20	21	32	32	32
	30	15	32	32	32
	50	9	22	32	32
	70	6	16	23	32
	100	4	11	16	23

Please read the E-boxes user manuals for more information about their setting.

Important: the item "E-box mode" has to be set at "Pass Thr" (Personality - E-box mode - Pass Thr).

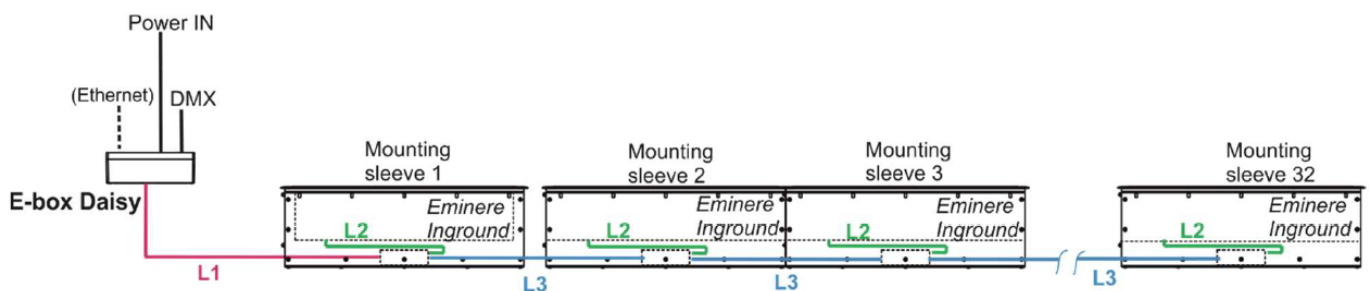

MOUNTING ACCESSORIES (ORDER SEPARATELY)

Mounting sleeve (Junction Box included)

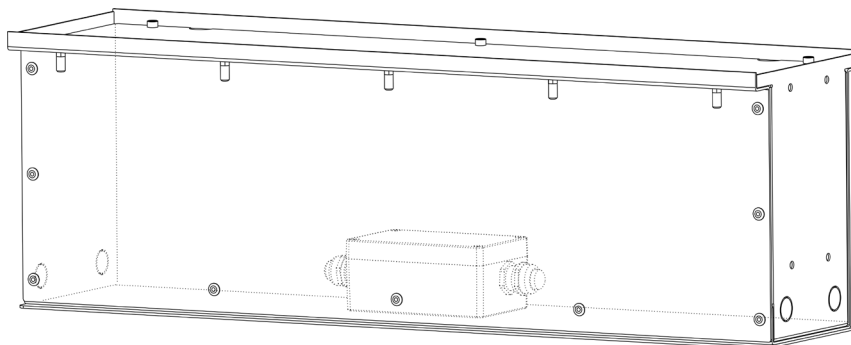

Cover Plates

Two types of Cover Plates must be ordered separately, depending on installation option:

- Cover Plate Continuous (includes set of 2pcs)
- Cover Plate End (includes set of 2pcs)

Examples:



Cover plate set-up for STAND ALONE option (consist of 1x set of Cover Plate Continuous and 1x set of Cover Plate End).
Cover Plate Continuous is always packed together with 1x Cover Plate Middle.

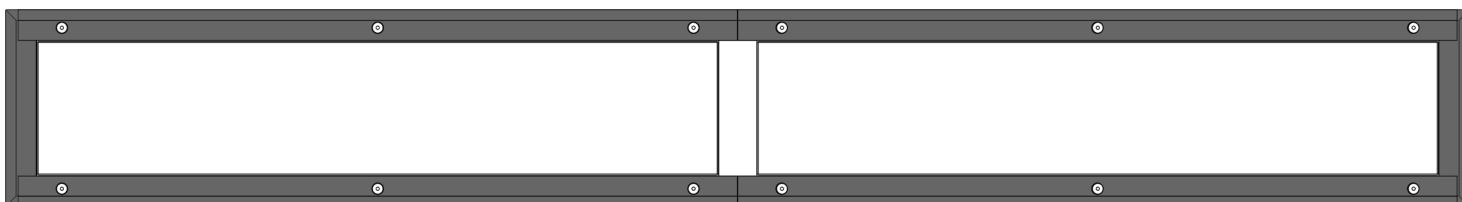

Cover plate set-up for HEAD2HEAD connection option (consist of 2x set of Cover Plate Continuous, 1x Cover Plate Middle and 1x set of Cover Plate End).
Cover Plate Continuous is always packed together with 1x Cover Plate Middle.

EMINERE INGROUND SPECIFICATION

Bi-symmetrical: 10°x30°, 10°x60°, 35°x70°, 15°x90°



Bi-symmetrical: 30°x10°, 60°x10°, 70°x35°, 90°x15°

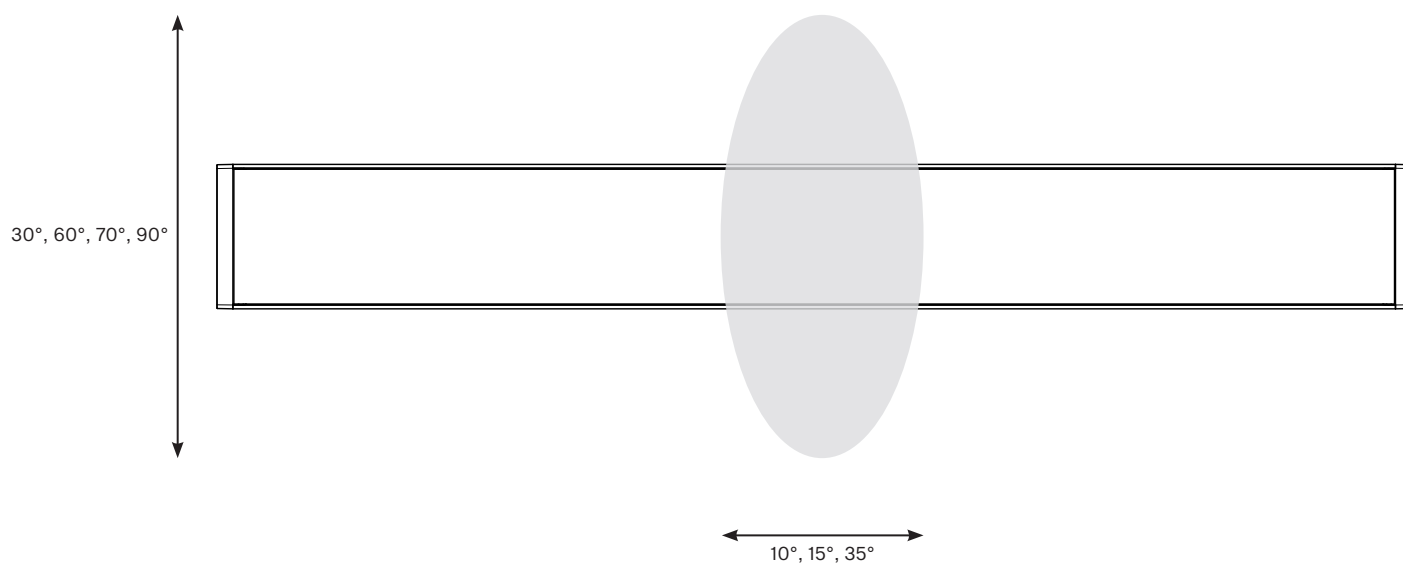

PHOTOMETRIC DATA

Eminere 4 Inground RGBCW
Clear Glass 9dg

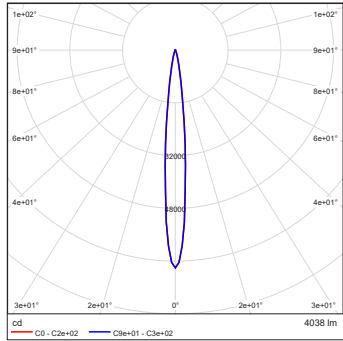

Eminere 4 RGBCW Inground
Clear Glass 15dg

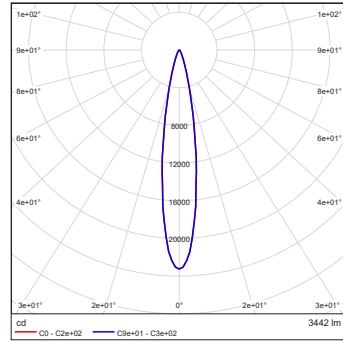

Eminere 4 RGBCW Inground
Clear Glass 30dg

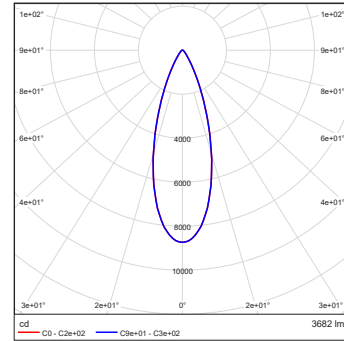

Eminere 4 RGBCW Inground
Clear Glass 50dg

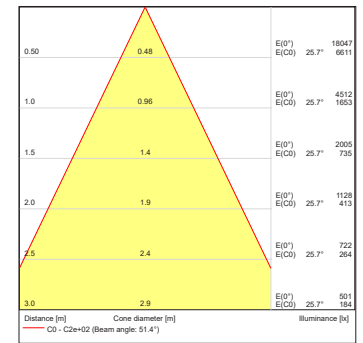
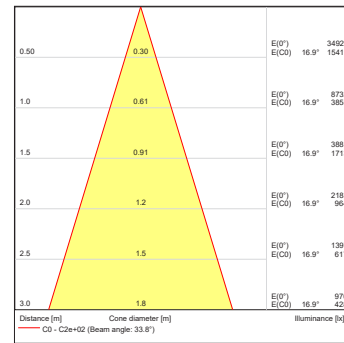
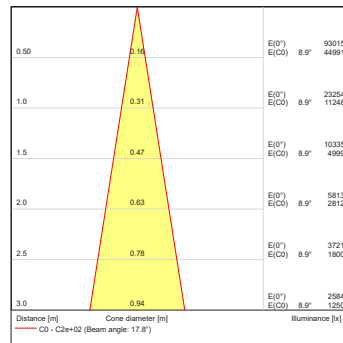
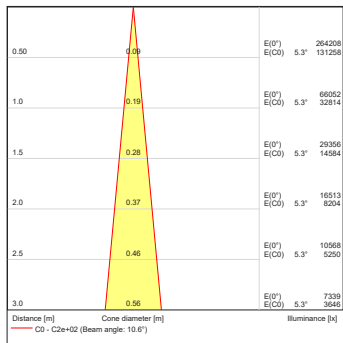
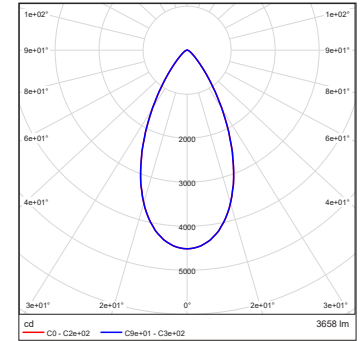

Eminere 4 RGBCW Inground
Clear Glass 65dg

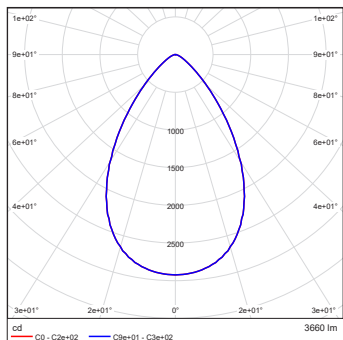

Eminere 4 RGBCW Inground
Clear Glass 100dg

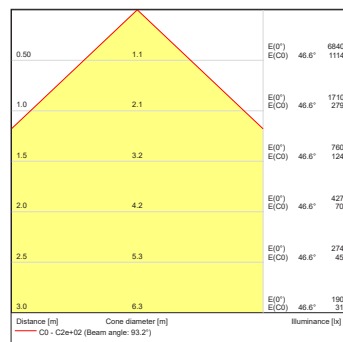
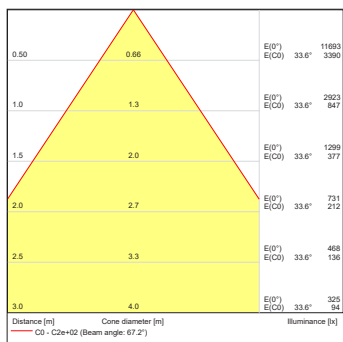
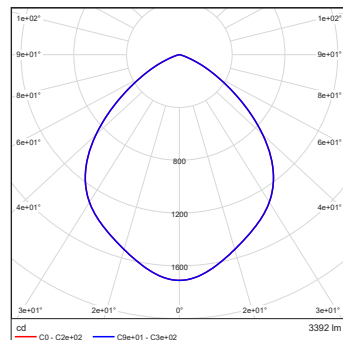

PHOTOMETRIC DATA

Eminere 4 RGBCW Inground
Clear Glass 10dg x 30dg

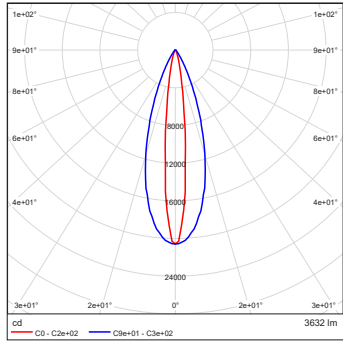

Eminere 4 RGBCW Inground
Clear Glass 10dg x 60 dg

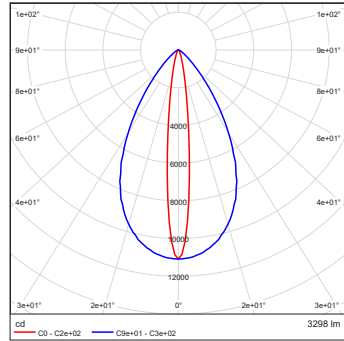

Eminere 4 RGBCW Inground
Clear Glass 35dg x 70dg

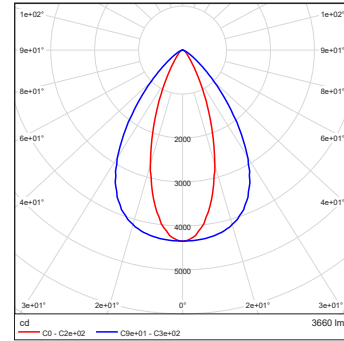

Eminere 4 RGBCW Inground
Clear Glass 15dg x 90dg

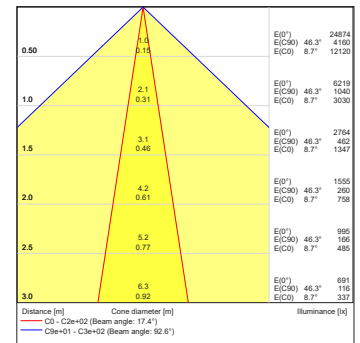
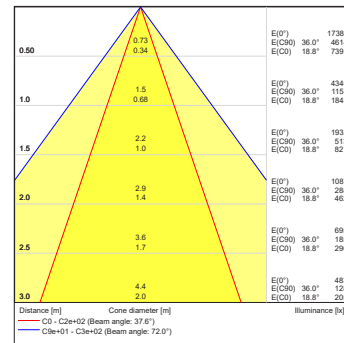
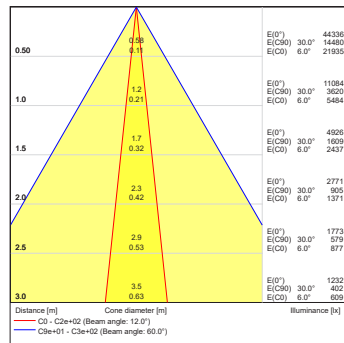
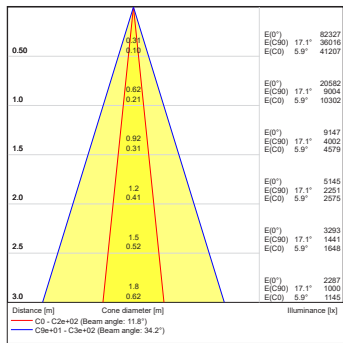
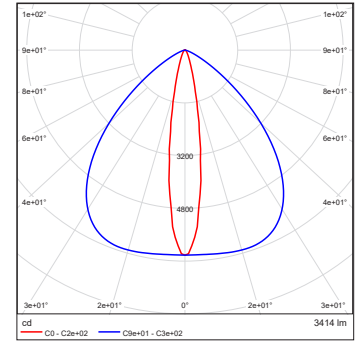

Eminere 4 RGBCW Inground
Clear Glass WallWasher

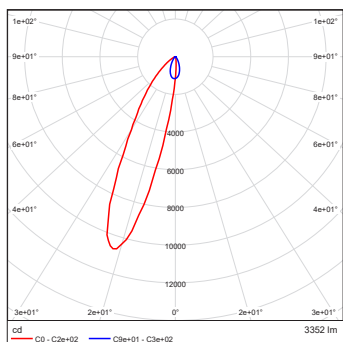

Eminere 4 RGBCW Inground
Clear Glass Wide WallWasher

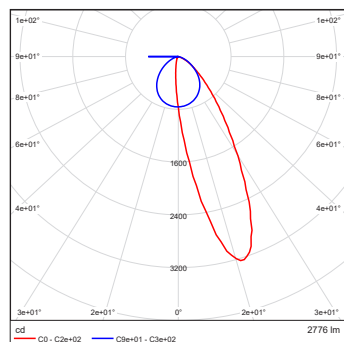

PHOTOMETRIC DATA

Eminere 4 Inground RGBCW
Anti-Skid Glass 18dg

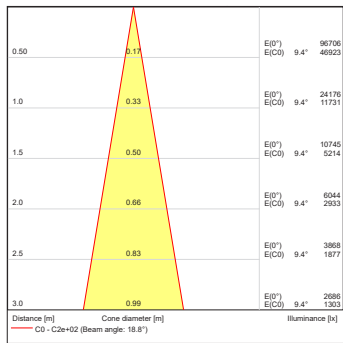
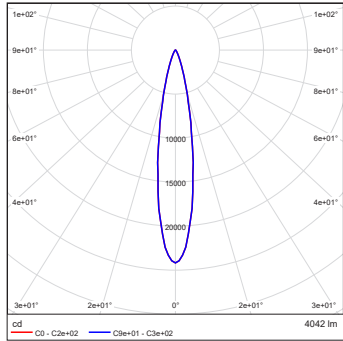

Eminere 4 RGBCW Inground
Anti-Skid Glass 22dg

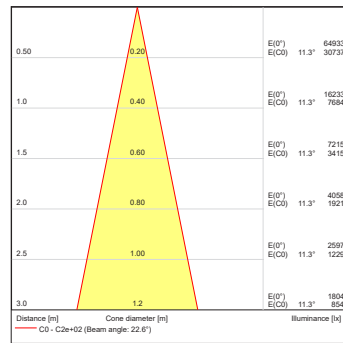
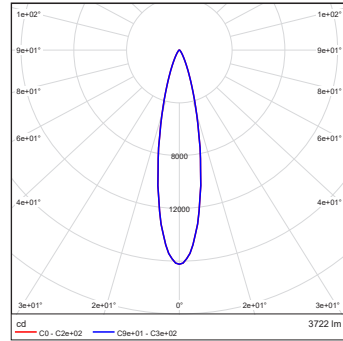

Eminere 4 RGBCW Inground
Anti-Skid Glass 35dg

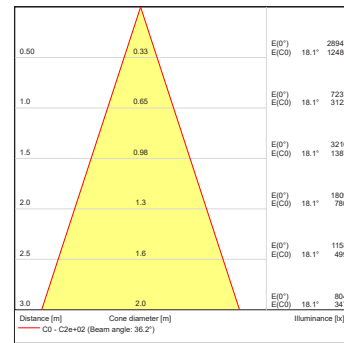
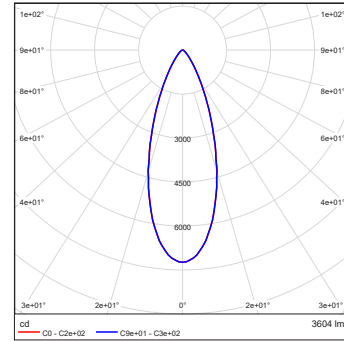

Eminere 4 RGBCW Inground
Anti-Skid Glass 50dg

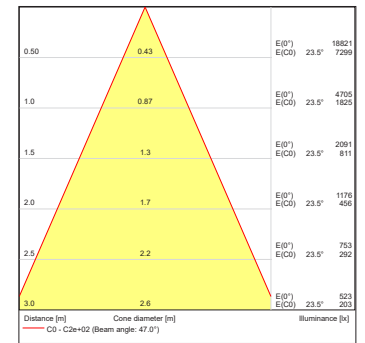
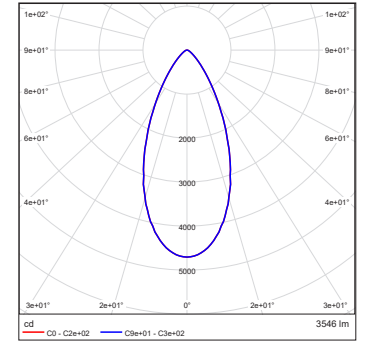

Eminere 4 RGBCW Inground
Anti-Skid Glass 65dg

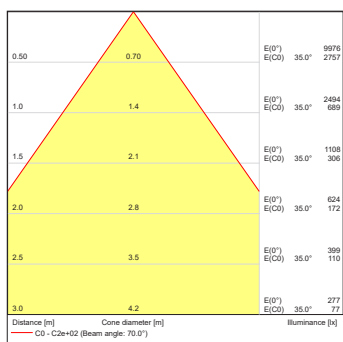
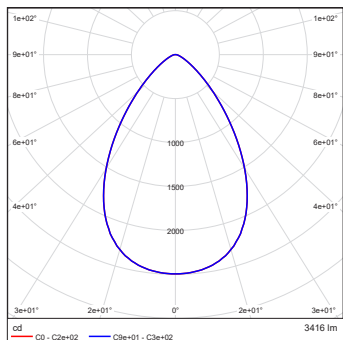

Eminere 4 RGBCW Inground
Anti-Skid Glass 100dg

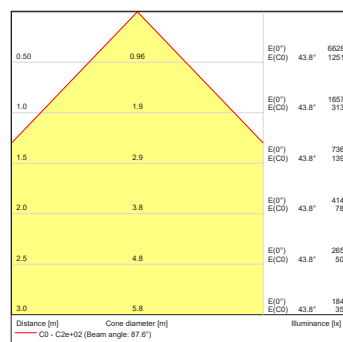
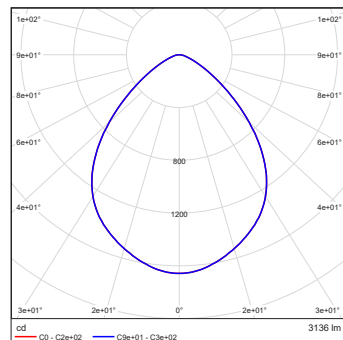

PHOTOMETRIC DATA

Eminere 4 RGBCW Inground
Anti-Skid Glass 20dg x 35dg

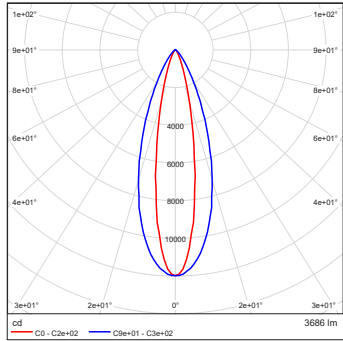

Eminere 4 RGBCW Inground
Anti-Skid Glass 20dg x 65dg

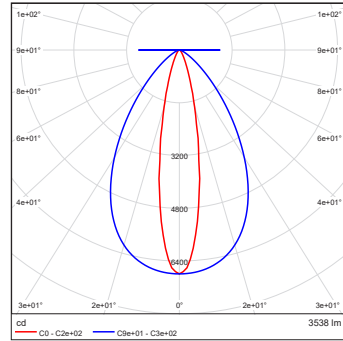

Eminere 4 RGBCW Inground
Anti-Skid Glass 40dg x 70dg

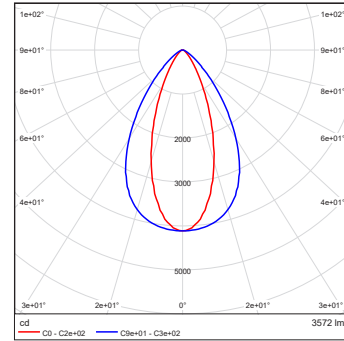

Eminere 4 RGBCW Inground
Anti-Skid Glass 20dg x 90dg

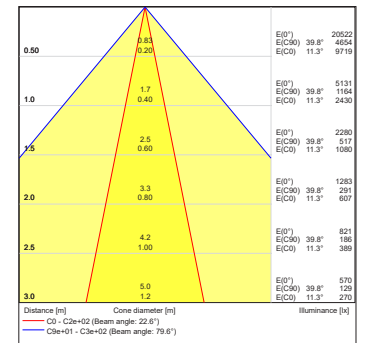
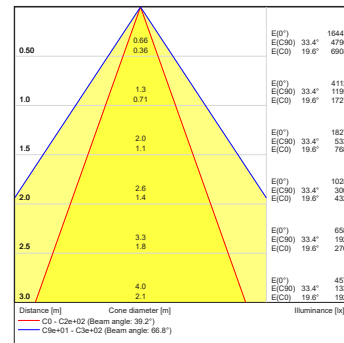
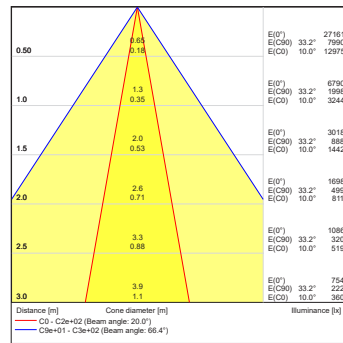
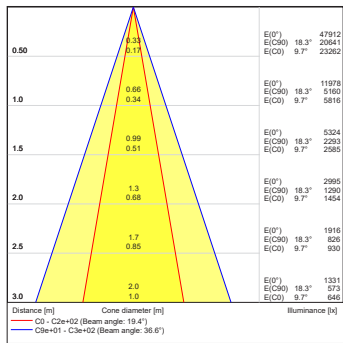
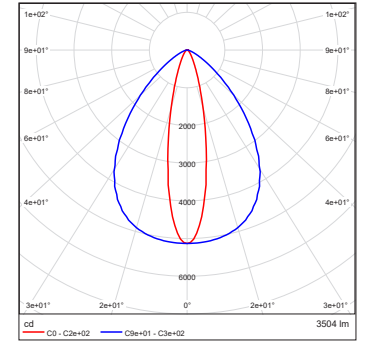

Eminere 4 RGBCW Inground
Anti-Skid Glass WallWasher

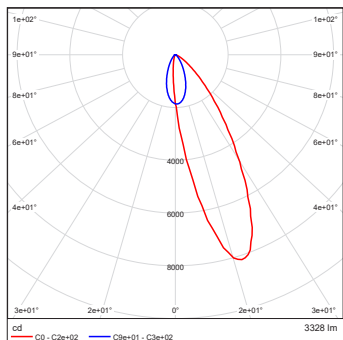

Eminere 4 RGBCW Inground
Anti-Skid Glass Wide WallWasher

