

QR code for Installations Instructions



The unit must be installed by a qualified electrician in accordance with all national and local electrical and construction codes and regulations.



STEP 1.A
INSTALLATION WITH STANDARD BRACKETS

1



Use fasteners that are appropriate for use with your mounting surface

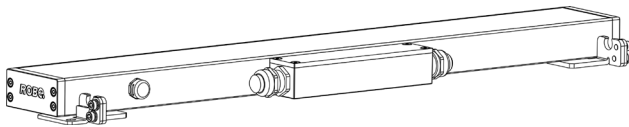

Drill two holes into the surface according to the given dimensions (Eminere Remote 1/2/4)
 Fasten the Eminere Remote to the surface by two washers, spring washers and screws.

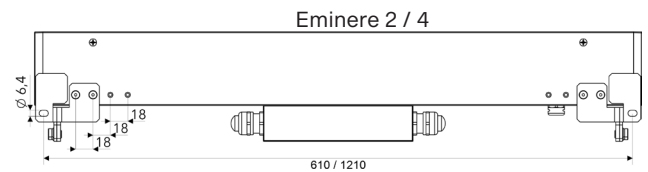
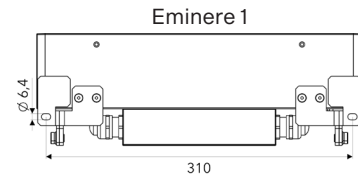

2

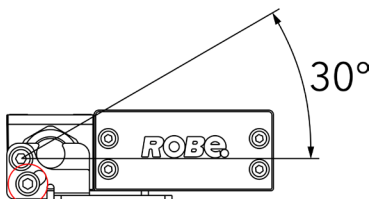

Loosen locking screws on both sides, adjust fixture to desired position and tighten locking screws on both sides.

STEP 1.B
INSTALLATION WITH WALL MOUNT BRACKETS

1



Use fasteners that are appropriate for use with your mounting surface

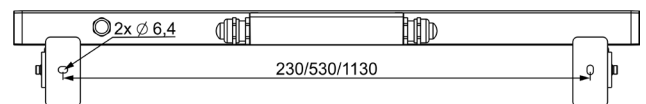
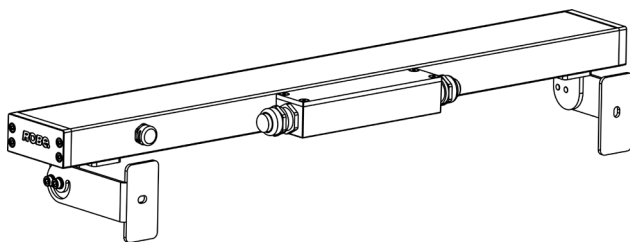

Drill two holes into the surface according to the given dimensions (Eminere Remote 1/2/4)
 Fasten the Eminere Remote to the surface by two washers, spring washers and screws.

2

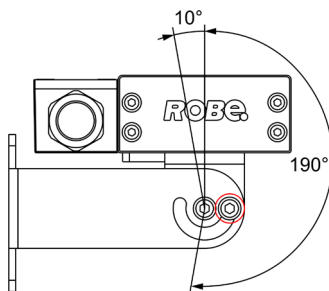

Loosen locking screws on both sides, adjust fixture to desired position and tighten locking screws on both sides.

STEP 1.C
INSTALLATION WITH MOUNTING BRACKETS
100/200/300 MM

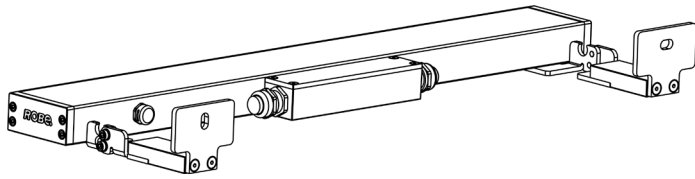

2

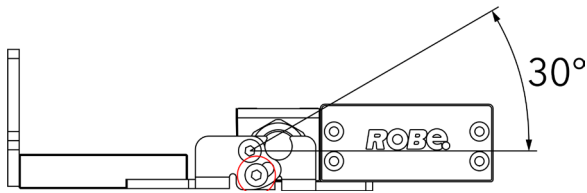

Loosen locking screws on both sides, adjust fixture to desired position and tighten locking screws on both sides.

1

! Use fasteners that are appropriate for use with your mounting surface **!**

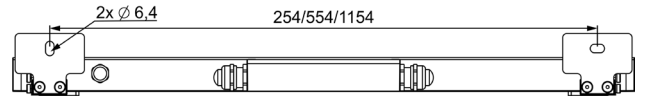

Drill two holes into the surface according the given dimensions (Eminere Remote 1/2/4)
 Fasten the Eminere Remote to the surface by two washers, spring washers and screws.

STEP 2
CONNECTION

1

4X M4x12

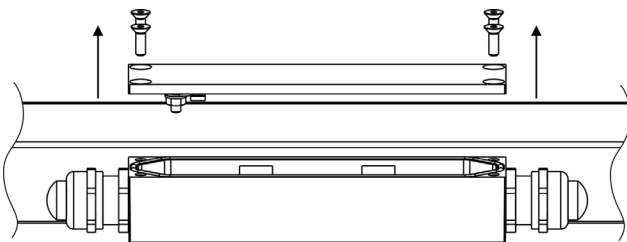

Uncover E-box.

2

A	
Power Connection	9mm
Data Connection	9mm

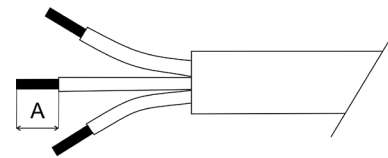

Strip these lengths for cable connections.

3 Connection – colour coding

LED Unit Connection - CE Leader

TERMINAL BLOCK	VCC	D+	D-	0V	GROUND
Colour of Wire	Red	Orange	White	Black	/

LED Unit Connection - US leader

TERMINAL BLOCK	VCC	D+	D-	0V	GROUND
Colour of Wire	Red	Orange	White	Black	Green/Yellow

4 Wiring connection

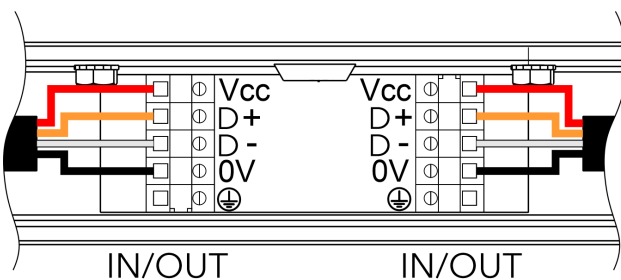

EU leader cable shown

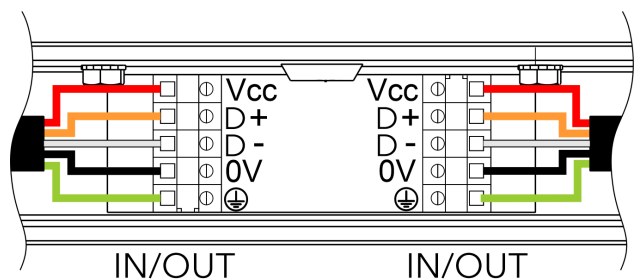

US leader cable shown

Note for E-box Remote Basic.

If the Emineres Remote UV are connected to the LED output of the E-box Remote Basic, the last Eminere Remote has to be terminated by a terminator. The terminator is a 120 Ohm resistor connected between terminals D+ and D- in the last fixture.

If both LED outputs of the E-box Remote Basic are used, both lines of Emineres Remote have to be terminated by the 120 Ohm resistor.

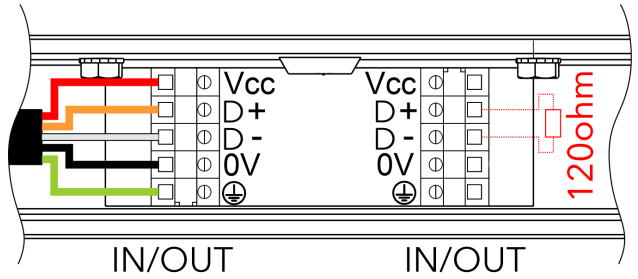

**STEP 3
CABLE GLAND INSTALLATION**

Use wrench size 24 for cable gland M20x1.5

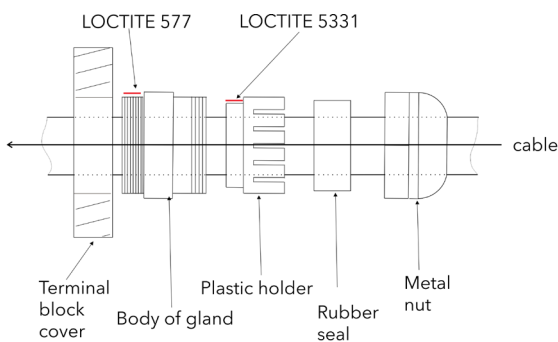

Apply Loctite 5331 thread sealant on the plastic holder and Loctite 577 thread locking compound on the gland body in the indicated locations prior to assembly.

Failure to properly install cable glands will result in failure of the water tight seal!

**STEP 4
FILLING CONNECTION BOX WITH SYNTHETIC RESIN**

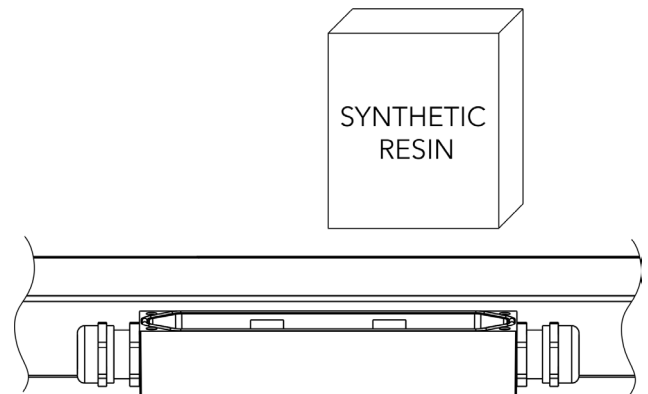

After checking all connections, fill the connection box with synthetic resin. Make sure the end cap is inserted in any unused cable glands, and the earth ground wire is pulled from the junction box before filling it with resin. Read and follow all instructions stated on the resin bag prior to filling the junction box. The connection box has to be fully filled by resin.

**STEP 5
CLOSE CONNECTION BOX**

4X M4x12



Install top cover back.

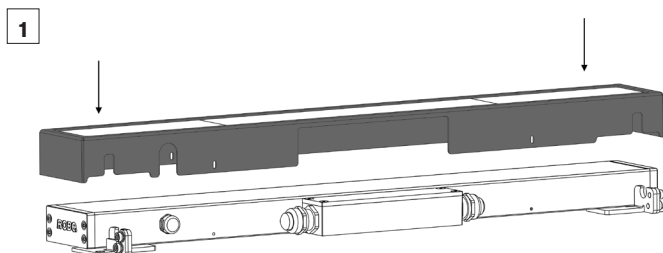

Place the black glass adaptor onto the fixture.

**STEP 7
INSTALLATION OF ACCESSORIES - BLACK GLASS ADAPTOR**

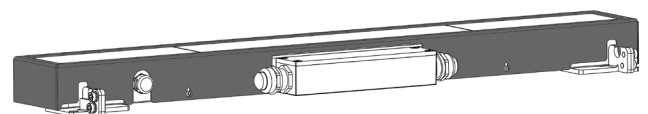

Eminere Remote with black glass adaptor

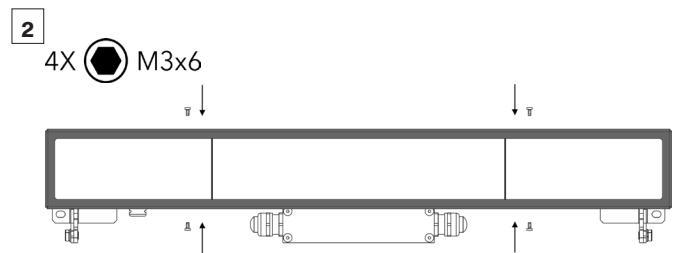

Fasten the adaptor to the fixture with 4 screws.