

LAMARI™ 1 / 2 / 3 / 4 SC

Our linear LED fixture is the ideal choice for professional lighting, offering outstanding color mixing. For enhanced safety, the fixture operates at 48V and is controlled via DALI 2 and E-Box Remote series controllers. The fixture's body is made from durable aluminum, boasting IK10 and IP67 ratings, ensuring high resistance to mechanical damage and harsh weather conditions. A wide range of beam angles is available, allowing precise adjustment to meet specific project requirements. The fixture is available in four length variants and offers multiple surface mounting options.



KEY FEATURES

Optic & Control

Advanced technology ensures precise blending of colours. Choose from a variety of beam angles to suit different lighting needs. 48V operation for safe usage in various environments.

Compact design

At only 39 mm of total height, Lamari SC has been designed as a compact and slim LED luminaire suitable for any low-profile application. Available in four length options with multiple mounting configurations.

Durability

Thanks to its tempered glass and high-pressure, extruded aluminum housing, Lamari SC is IK10 and IP67 certified. For more extreme and marine applications, a harsh environment finish option is also available.

COLOURS



CONTROL & PROTOCOLS



STANDARD & SPECIFICATION

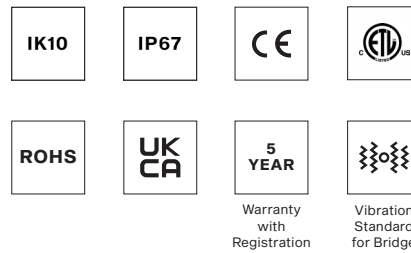

FINISH OPTIONS

* CLOSEST RAL TONE
* HE = Harsh Environment

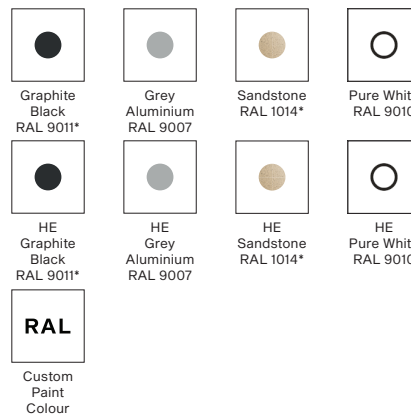

COLOUR TEMPERATURE

* UPON REQUEST



OPTIC OPTIONS

SYMMETRICAL

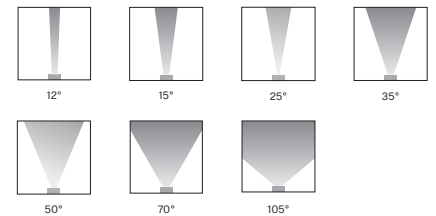

BI-SYMMETRICAL

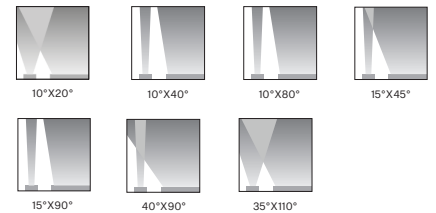

SPECIFICATION

ELECTRICAL	Input Voltage	48 V			
	Typical Power Consumption	Lamari SC 1: 10 W	Lamari SC 2: 20 W		
		Lamari SC 3: 30 W	Lamari SC 4: 40 W		
OPTICAL	Light Source	Lamari SC 1 / 2 / 3 / 4: 8 / 16 / 24 / 32 High Power LEDs			
	Colour Variants	PW 3000K, TW 2200–3000 K Upon Request: PW 2200K, 2700 K, 4000 K, 6500 K			
	Beam Angle	Without Linear Louvre	Symmetrical:	12° 15° 25° 35° 50° 70° 105°	
			Bi-symmetrical:	10°x20° 10°x40° 10°x80° 15°x45° 15°x90° 35°x110° 45°x65°	
	With Linear Louvre <small>*Low Glare Accessories</small>	Symmetrical:	12° 15° 25°		
		Bi-symmetrical:	10°x20° 10°x40° 10°x80° 15°x45° 15°x90° 35°x110°		
Lumen Output Delivered	Lamari SC 1: 591 lm, (SC, PW 2700K) TBC		Lamari SC 3: 1911 lm, (SC, TW @3000K) TBC		
	Lamari SC 2: 1274 lm, (SC, TW @3000K) TBC		Lamari SC 4: 2548 lm, (SC, TW @3000K) TBC		
Projected Lumen Maintenance	L90B10 >90.000 hrs, Ta = 25°C / 77°F				
CONTROL	Interface Protocol	Via E-Box Remote range, DALI 2			
	E-Box Remote Control Protocols	USITT DMX512, RDM, ArtNet, MA Net, MA Net2, sACN, Kling-Net			
	Operating Modes	Pixel (per 1/2 Foot) or Fixture mode			
	Setting / Addressing	Via Two Row LCD Display with Control Buttons on E-Box Remote or RDM communicator			
	Power Supply	Via E-Box Remote range			
	Connectivity	E-box Remote E-box Remote Basic			
Width x Height x Length		Rear:		Side:	
	Lamari SC 1	37 x 39 x 339 mm (1.46 x 1.54 x 13.4 in.)		37 x 39 x 339 mm (1.46 x 1.54 x 13.4 in.)	
	Lamari SC 2	37 x 39 x 647 mm (1.46 x 1.54 x 25.5 in.)		37 x 39 x 647 mm (1.46 x 1.54 x 25.5 in.)	
	Lamari SC 3	37 x 39 x 956 mm (1.46 x 1.54 x 37.6 in.)		37 x 39 x 956 mm (1.46 x 1.54 x 37.6 in.)	
	Lamari SC 4	37 x 39 x 1264 mm (1.46 x 1.54 x 49.8 in.)		37 x 39 x 1264 mm (1.46 x 1.54 x 49.8 in.)	
Weight 1 / 2 / 3 / 4	0.9 kg 2.0 lbs	1.6 kg 3.5 lbs	2.2 kg 4.9 lbs	2.8 kg 6.2 lbs	
Housing	High Pressure Extruded Aluminium Body End Caps – Die-Cast Aluminium Tempered Glass				
PHYSICAL	Finish Options	Standard Colour	Graphite Black RAL 9011* Grey Aluminium RAL 9007 Pure White RAL 9010 Sandstone RAL 1014* <small>*Closest RAL Tone</small>		
		Standard Colour Harsh Environment	Graphite Black RAL 9011* Grey Aluminium RAL 9007 Pure White RAL 9010 Sandstone RAL 1014* <small>*Closest RAL Tone</small>		
		Cost Option	Custom RAL		
Cables/Connections	IP67 Hybrid Connection (Power + Data)				
Mounting Method	Surface Mount With Different Type of Brackets				
Adjustability	+10° (With Standard Mounting Bracket)				
Protection Factor IK Rating	IP67 / Suitable For Wet Locations IK10				
Cooling System	Convection				
Operating Ambient Temperature	-20°C / +40°C (-4°F / +104°F)				
Operating Temperature	+67°C @ Ambient +40°C (+153°F @ Ambient +104°F)				
CERTIFICATION	Listings	ETL / cETL, CE, RoHS, UKCA			
ACCESSORIES	Included Items	Waterproof Cap for M connector AD-05			
		Waterproof Cap for F connector AD-05			
	Not Included Items	Optical Demo Set for Lamari 1 2 3 4			
		Wall Mount Brackets			
		Wall Mount Scissors Brackets			
Shield for Lamari:	Rear 1 2 3 4		Side 1 2 3 4		
Barndoors (with or without Side Covers) for Lamari 1 2 3 4					

SPECIFICATION

**CABLES
AND
CONNECTORS**

Leader Cable FF, 0.1 m, CE AD-05
Jumper Cable MM/FF CE AD-05, 0.5 m 1 m 3 m 5 m
T-connector FMF CE AB-AD-05
Cable SJTW 5x14 AWG black
Cable SJTW 5x14 AWG white
Field Installable Connector FF DC-05 (for 5x14 AWG)
Field Installable Connector FM DC-05 (for 5x14 AWG)
Connection Box Remote 1xOut
Connection Box Remote 2xOut

LAMARI INPUT OPTIONS

STANDARD

UPON REQUEST

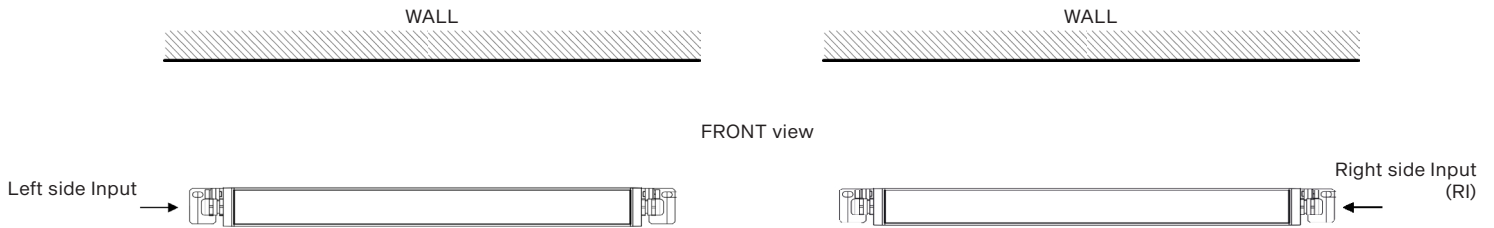

DISTANCE FROM THE WALL

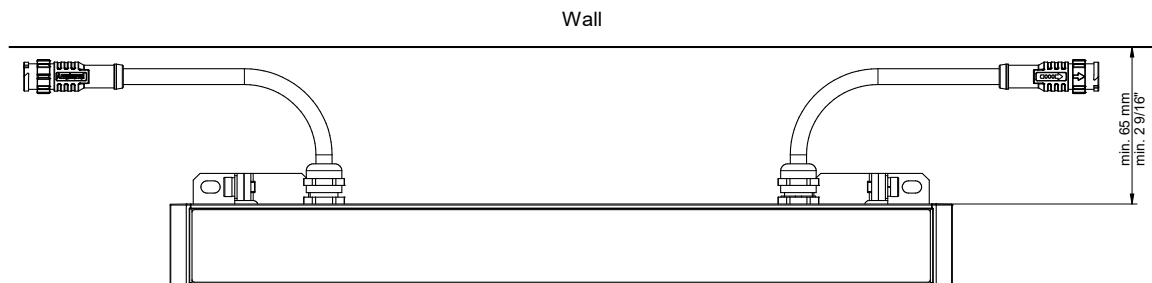

CONTROL AND CONNECTION OPTIONS

STANDARD

- 1) Leader Cable FF, 0.1 m, CE AD-05 (I3053978)
- 2) Cable 5x20 AWG, 0.5 m, with connector MM
- 3) Cable 5x20 AWG, 0.1 m, with connector FF

E-Box Remote /
Remote Basic /
Remote Basic Mini

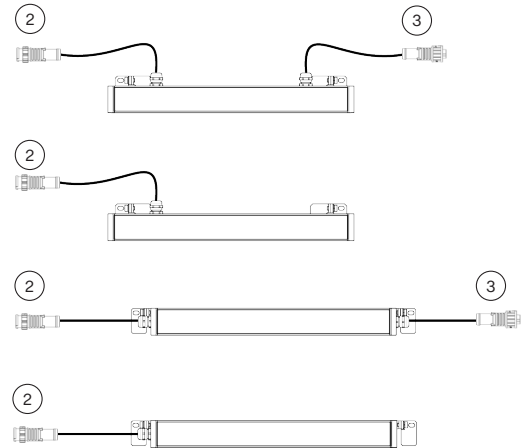
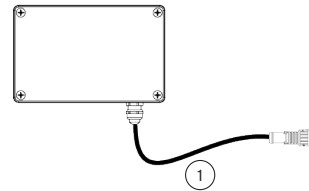

Note: The last unplugged connector must be fitted with a Waterproof Cap to protect the IP rating.

STANDARD WITH JUMPER CABLE

- 1) Leader Cable FF, 0.1 m, CE AD-05 (I3053978)
- 2) Cable 5x20 AWG, 0.5 m, with connector MM
- 3) Cable 5x20 AWG, 0.1 m, with connector FF
- 4) Jumper Cable MM/FF - 0.5 m | 1 m | 3 m | 5 m

E-Box Remote /
Remote Basic /
Remote Basic Mini

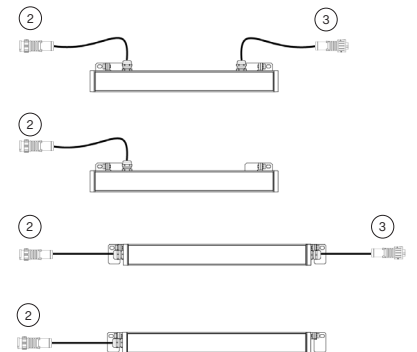
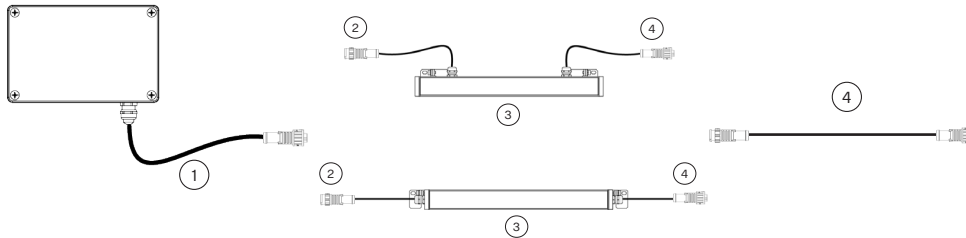

Note: The last unplugged connector must be fitted with a Waterproof Cap to protect the IP rating.

DALI VERSION (CE)

- 1) Junction Box Remote with 5x20 AWG, 0.1 m, with connector FF
- 2) Cable 5x20 AWG, 0.5 m, with connector MM
- 3) Cable 5x20 AWG, 0.1 m, with connector FF

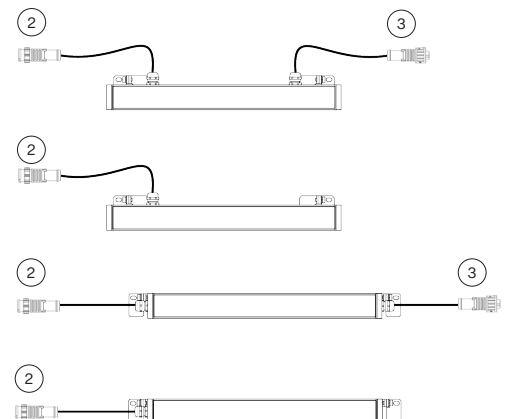
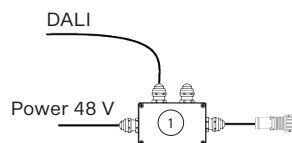

Note: The last unplugged connector must be fitted with a Waterproof Cap to protect the IP rating.

CONTROL AND CONNECTION OPTIONS

DMX WITH CONNECTION BOX FOR LAMARI

A

- 1) SJTW 5x14 AWG (13053336), standard with bare-end, black or Cable SJTW 5x14 AWG (13053697), with bare-end, white (on request)
- 2) Field Installable Connector FF DC-05 (13053971)
- 3) Connection Box Remote 1x Out (14 AWG–20 AWG), Cable 5x20 AWG, 0.1 m, with connector FF
- 4) T-connector FMF (13053941)
- 5) Cable 5x20 AWG, 0.5 m, with connector MM
- 6) Cable 5x20 AWG, 0.1 m, with connector FF

Note: The last unmated connector must be fitted with an Waterproof Cap to protect the IP rating.

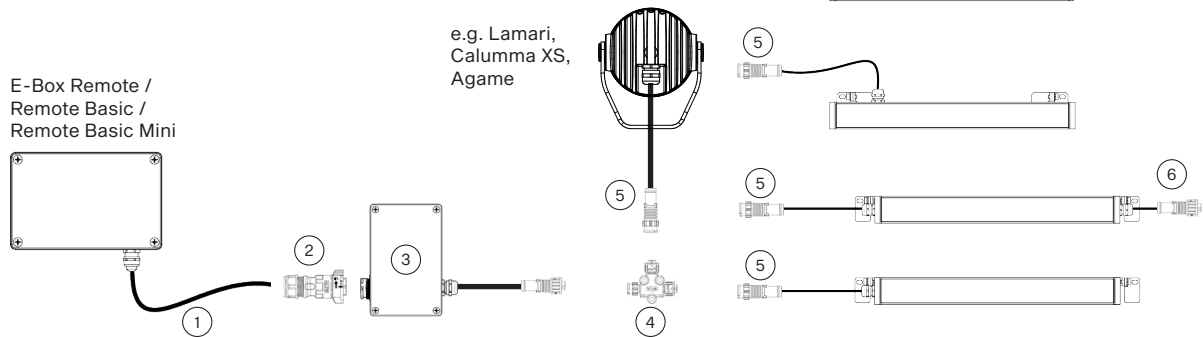

B

- 1) SJTW 5x14AWG (13053336), standard with bare-end, black or Cable SJTW 5x14AWG (13053697), with bare-end, white (on request)
- 2) Field Installable Connector FF DC-05 (13053971)
- 3) Connection Box Remote 2x Out (14 AWG–14 AWG & 20 AWG), Cable 5x20 AWG, 0.1 m, with connector FF
- 4) Cable 5x20 AWG, 0.1 m, with connector FF
- 5) Field Installable Connector FM DC-05 (13053973)
- 6) Cable 5x20 AWG, 0.5 m, with connector MM

Note: The last unmated connector must be fitted with an Waterproof Cap to protect the IP rating.

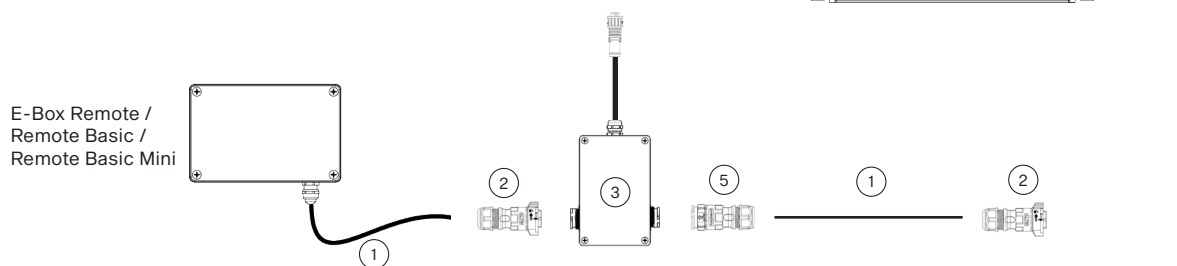

LAMARI CABLE ENTRY OPTIONS

Rear IN/OUT Version



Rear IN Version



Side IN/OUT Version



Side IN Version



DIMENSIONS

Rear IN/OUT Version

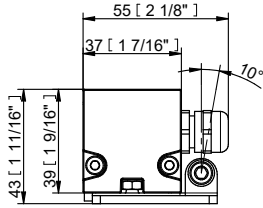

Wall

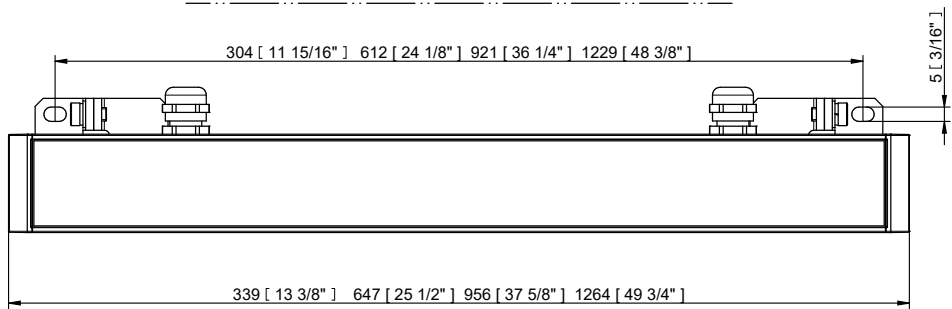

Rear IN Version

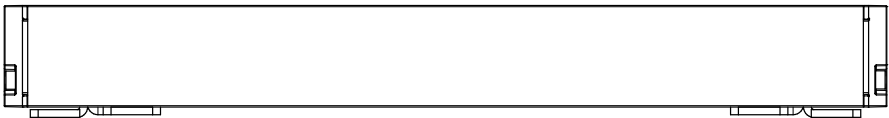
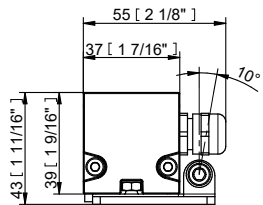

Wall

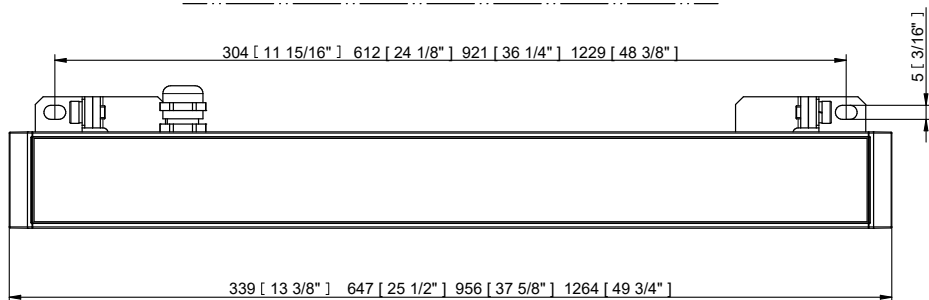

Side IN/OUT Version

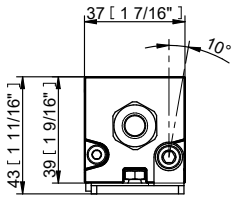

Wall

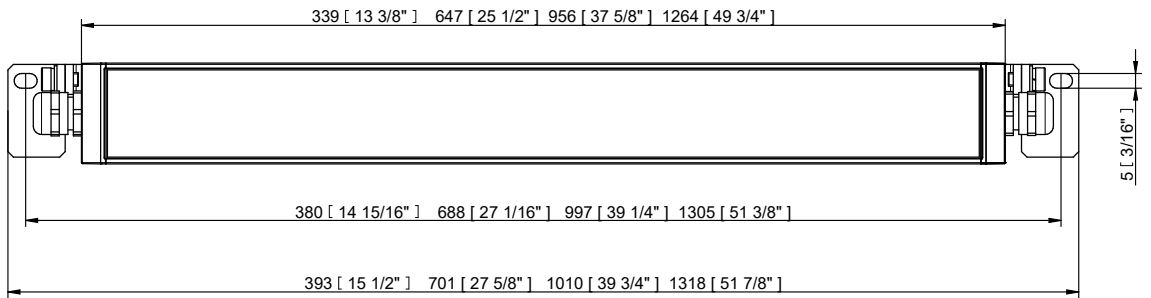

Side IN Version

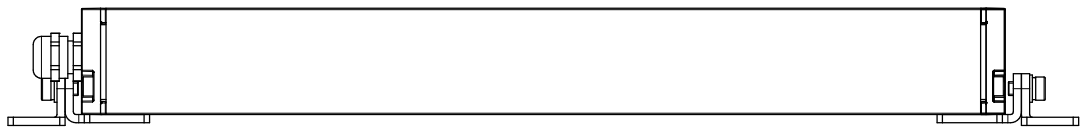
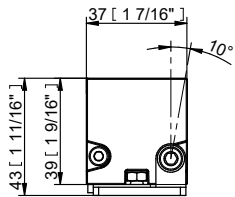

Wall

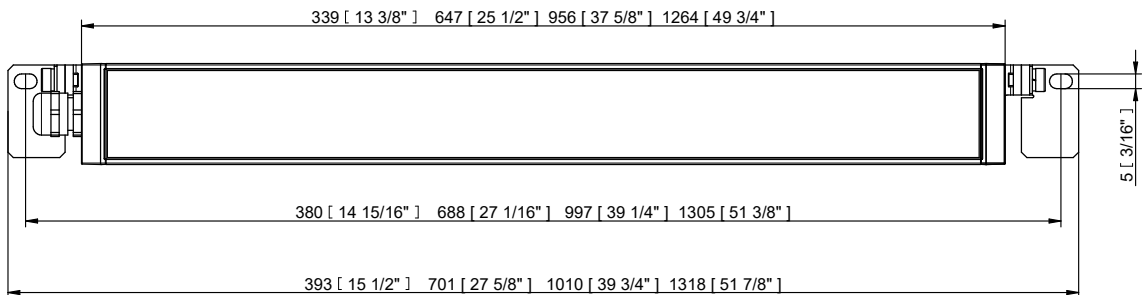

ACCESSORIES

Barndoors for Lamari Side

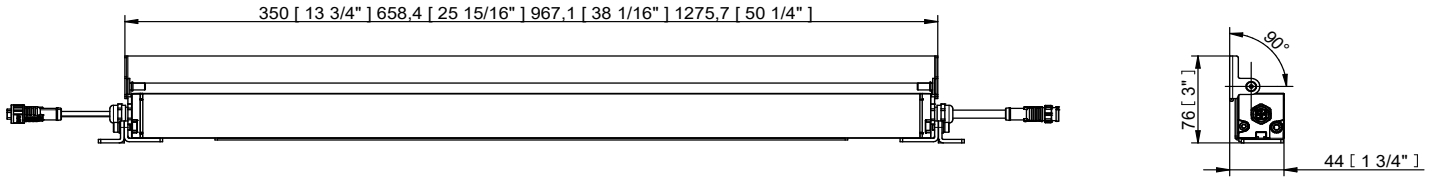

Barndoors for Lamari Rear

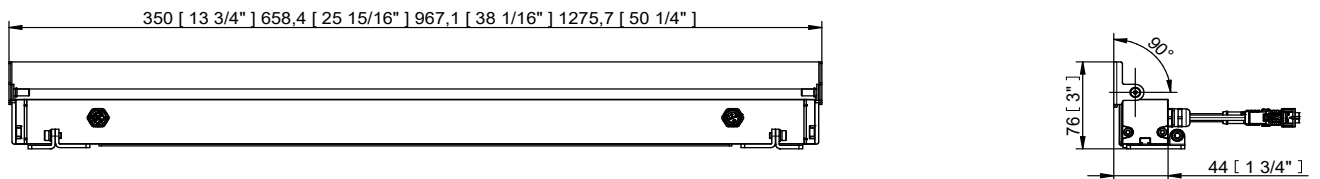

Shields for Lamari Side

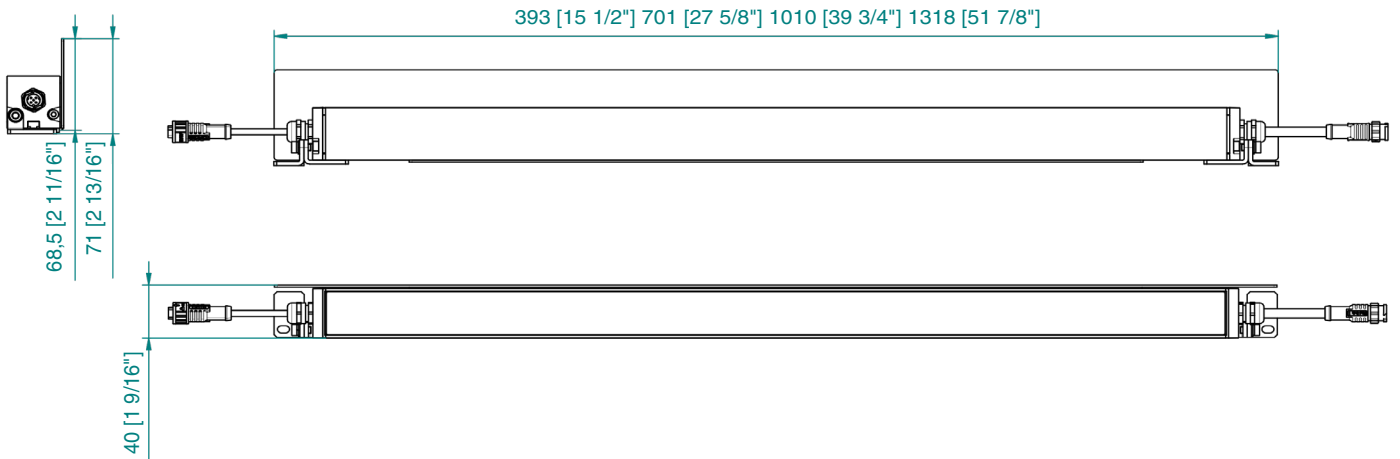

Shields for Lamari Rear

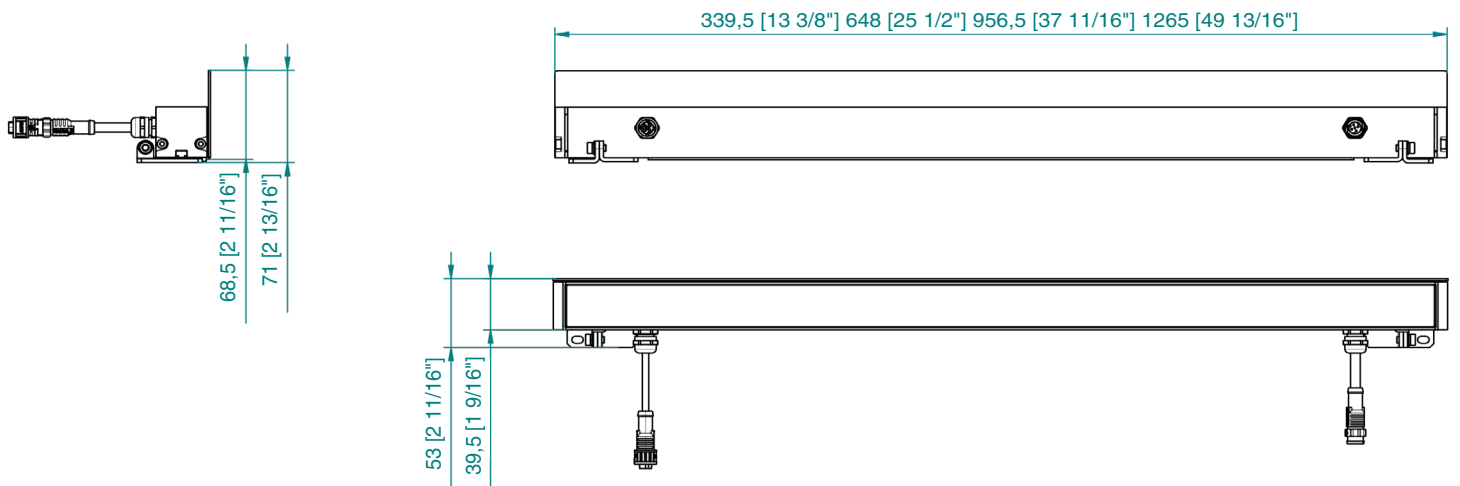

Wall Mount Brackets

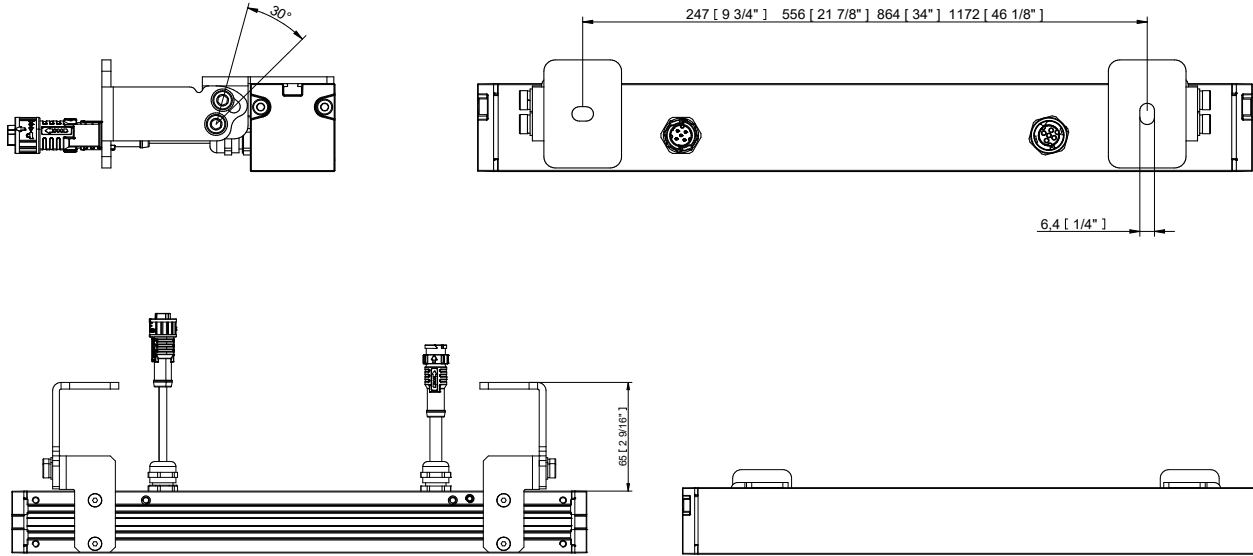

Wall Mount Scissors Brackets

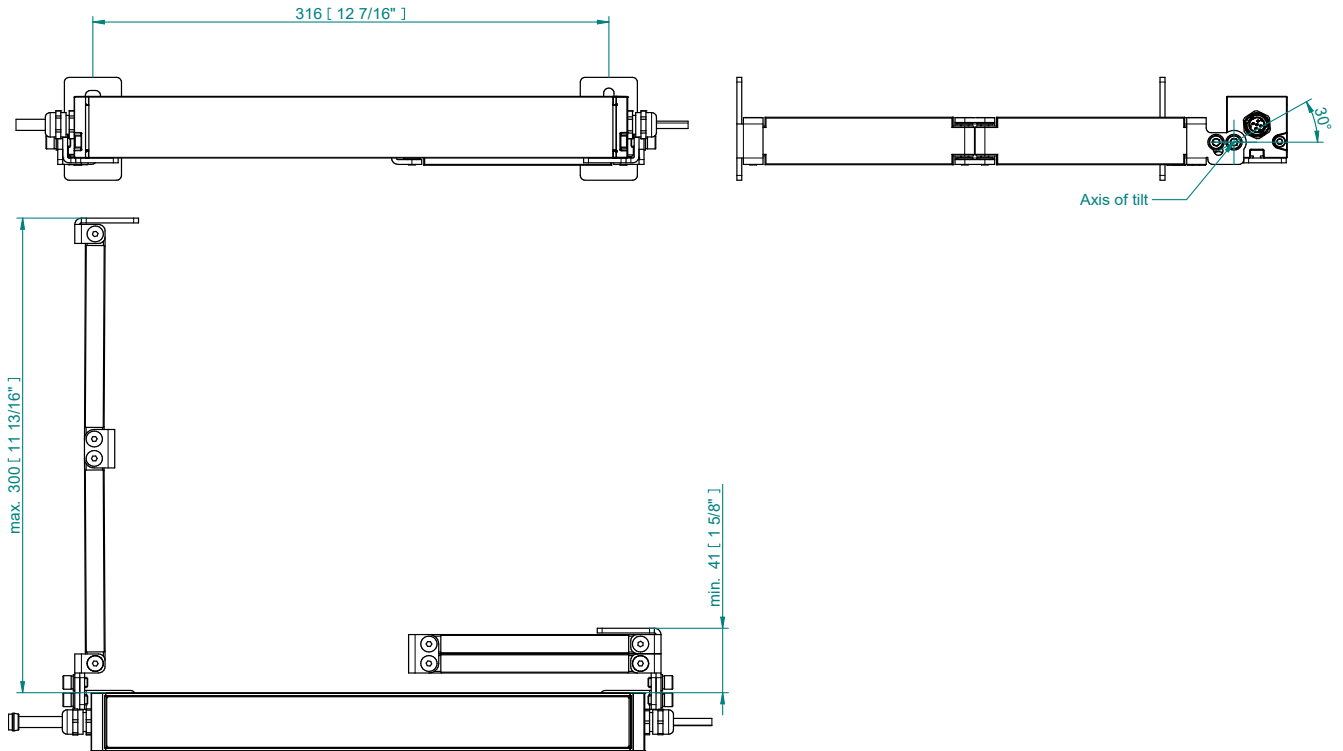

BI-SYMMETRICAL BEAM ANGLES

Bi-symmetrical: 15°x40°, 15°x70°, 20°x45°, 20°x80°, 35°x110°, 40°x65°

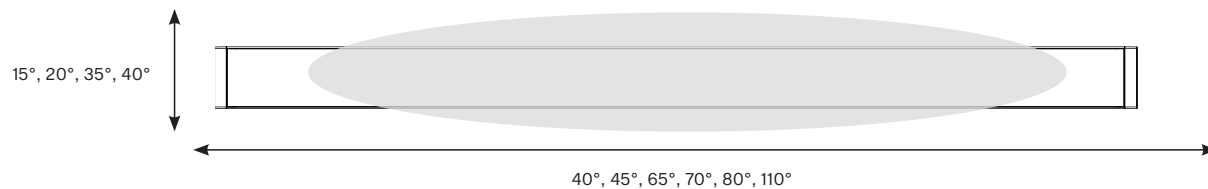

PHOTOMETRIC DATA

Lamari SC 4 TW (2200K–3000K)
12dg set to 3000K

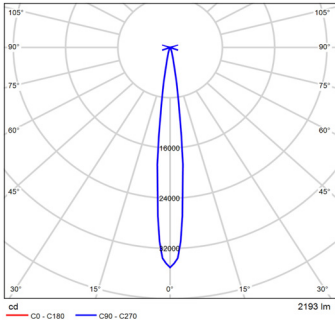

Distance [m]	Cone diameter [m]	E(0°) E(C0)	E(0°) E(C270)
0.50	0.11	140126 69913	6.2° 140126 69913
1.0	0.22	35031 17478	6.2° 35031 17478
1.5	0.33	15070 7788	6.2° 15070 7788
2.0	0.43	8788 4370	6.2° 8788 4370
2.5	0.54	5605 2797	6.2° 5605 2797
3.0	0.65	3892 1942	6.2° 3892 1942

Lamari SC 4 TW (2200K–3000K)
15dg set to 3000K

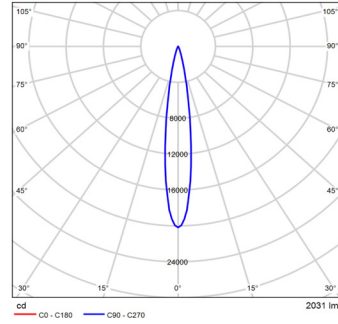

Distance [m]	Cone diameter [m]	E(0°) E(C0)	E(0°) E(C270)
0.50	0.14	80687 36365	7.7° 80687 36365
1.0	0.27	20172 9841	7.7° 20172 9841
1.5	0.41	8965 4374	7.7° 8965 4374
2.0	0.54	5043 2460	7.7° 5043 2460
2.5	0.68	3227 1575	7.7° 3227 1575
3.0	0.81	2241 1093	7.7° 2241 1093

Lamari SC 4 TW (2200K–3000K)
25dg set to 3000K

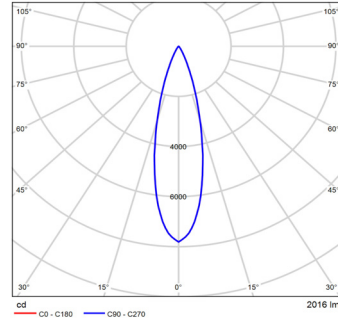

Distance [m]	Cone diameter [m]	E(0°) E(C0)	E(0°) E(C270)
0.50	0.23	31249 14481	13.2° 31249 14481
1.0	0.47	7812 3613	13.2° 7812 3613
1.5	0.70	3472 1606	13.2° 3472 1606
2.0	0.94	1953 903	13.2° 1953 903
2.5	1.2	1250 578	13.2° 1250 578
3.0	1.4	868 401	13.2° 868 401

Lamari SC 4 TW (2200K–3000K)
35dg set to 3000K

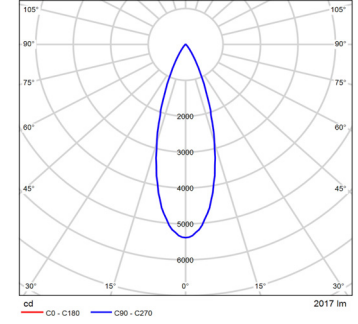

Distance [m]	Cone diameter [m]	E(0°) E(C0)	E(0°) E(C270)
0.50	0.29	21529 9535	16.4° 21529 9535
1.0	0.59	5382 2384	16.4° 5382 2384
1.5	0.88	2392 1059	16.4° 2392 1059
2.0	1.2	1346 596	16.4° 1346 596
2.5	1.5	861 381	16.4° 861 381
3.0	1.6	598 285	16.4° 598 285

Lamari SC 4 TW (2200K–3000K)
50dg set to 3000K

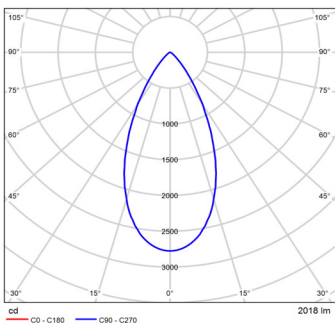

Distance [m]	Cone diameter [m]	E(0°) E(C0)	E(0°) E(C270)
0.50	0.45	11104 4195	24.4° 11104 4195
1.0	0.91	2776 1049	24.4° 2776 1049
1.5	1.4	1234 466	24.4° 1234 466
2.0	1.8	694 262	24.4° 694 262
2.5	2.3	444 168	24.4° 444 168
3.0	2.7	308 117	24.4° 308 117

Lamari SC 4 TW (2200K–3000K)
70dg set to 3000K

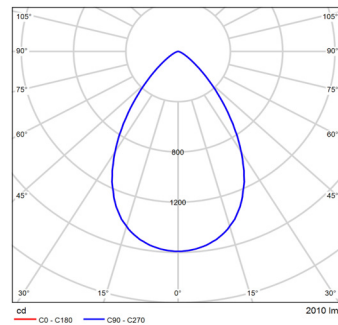

Distance [m]	Cone diameter [m]	E(0°) E(C0)	E(0°) E(C270)
0.50	0.68	6364 1851	34.2° 6364 1851
1.0	1.4	1591 469	34.2° 1591 469
1.5	2.0	707 209	34.2° 707 209
2.0	2.7	398 119	34.2° 398 119
2.5	3.4	255 75	34.2° 255 75
3.0	4.1	177 50	34.2° 177 50

Lamari SC 4 TW (2200K–3000K)
105dg set to 3000K

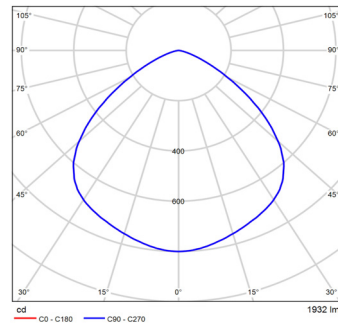

Distance [m]	Cone diameter [m]	E(0°) E(C0)	E(0°) E(C270)
0.50	1.3	3322 971	52.1° 3322 971
1.0	2.6	800 230	52.1° 800 230
1.5	3.9	356 101	52.1° 356 101
2.0	5.1	200 57	52.1° 200 57
2.5	6.4	128 36	52.1° 128 36
3.0	7.7	89 25	52.1° 89 25

Lamari SC 4 TW (2200K–3000K)
10dg x 20dg set to 3000K

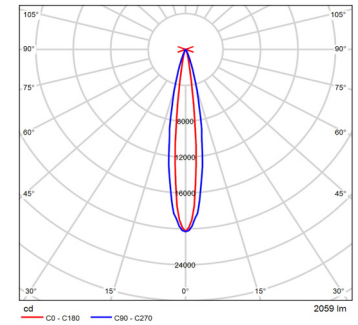

Distance [m]	Cone diameter [m]	E(0°) E(C0)	E(0°) E(C270)
0.50	0.17	81172 39222	9.8° 81172 39222
1.0	0.35	20293 9756	9.8° 20293 9756
1.5	0.52	9019 4328	9.8° 9019 4328
2.0	0.69	5073 2439	9.8° 5073 2439
2.5	0.86	3247 1561	9.8° 3247 1561
3.0	1.0	2385 1132	9.8° 2385 1132

Lamari SC 4 TW (2200K–3000K)
10dg x 40dg set to 3000K

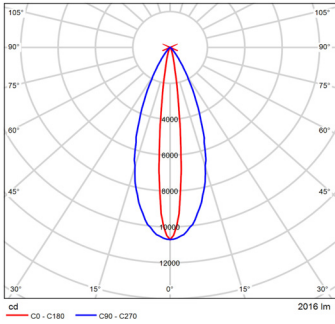

Lamari SC 4 TW (2200K–3000K)
10dg x 80dg set to 3000K

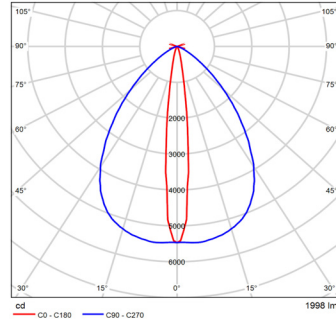

Lamari SC 4 TW (2200K–3000K)
15dg x 45dg set to 3000K

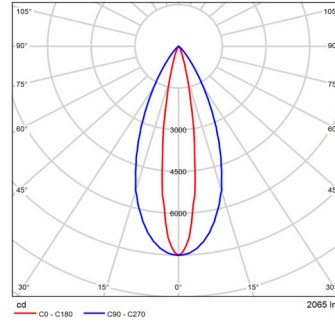

Lamari SC 4 TW (2200K–3000K)
15dg x 90dg set to 3000K

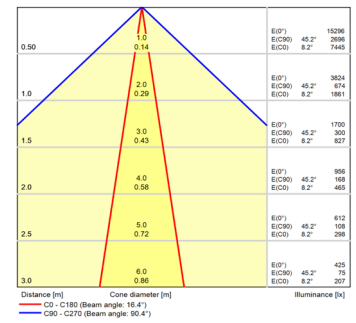
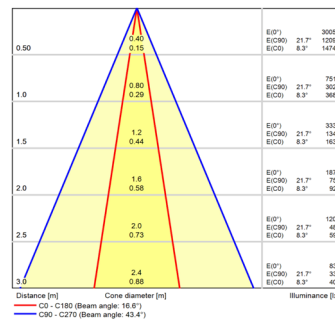
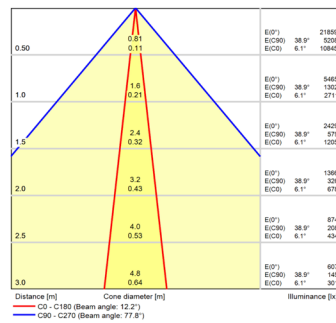
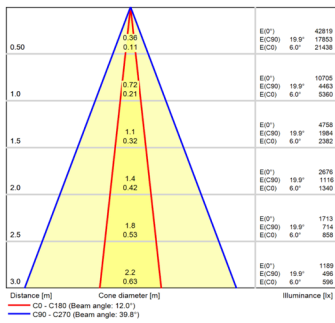
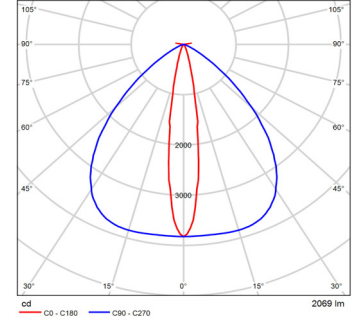

Lamari SC 4 TW (2200K–3000K)
35dg x 110dg set to 3000K

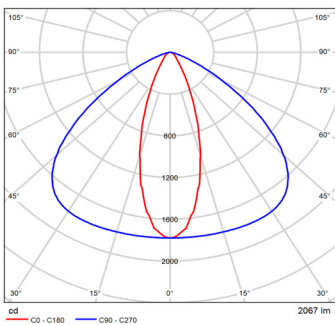

Lamari SC 4 TW (2200K–3000K)
40dg x 65dg set to 3000K

