

# CALUMMA™ XS MC

Using a single high-power, multi-chip LED inside a compact, elegant, and durable housing, the smallest Calumma is a great choice for many different lighting applications. Complementing both outdoor environments and interior designs, its wide range of beam angles, LED chip colour variant options and accessories make the Calumma XS MC an ideal, extra small lighting solution for any architectural design.



## KEY FEATURES

### Lumen output & Light source

Luminaire with one high-power, multi-chip LED provides light output up to 333 lumens with an efficacy of 33 lm/w. Offering a choice of multiple LED colour variants, precise beam control with no light spill, and perfectly homogenised light output, it's an excellent solution for applications requiring high performance in a compact luminaire.

### Design & Durability

Lightweight, compact, durable and stylish housing made of high-pressure die cast aluminium. IP67 and IK10 certification; suitable for marine applications (Harsh Environment Finish required) and traffic applications. Supported with a 5 year warranty.

### Flexibility

An exceptionally compact luminaire available with a wide range of accessories, custom colour finishes, LED choices, and beam angle options, Calumma XS offers the lighting designer a flexible solution for the most demanding applications.

## COLOURS

\* UPON REQUEST

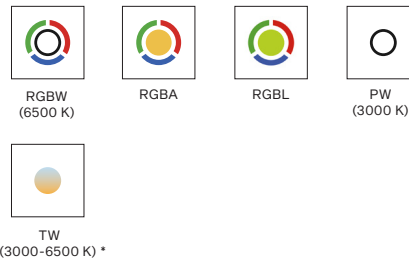

## CONTROL & PROTOCOLS



## FINISH OPTIONS

\* CLOSEST RAL TONE  
\* HE = Harsh Environment

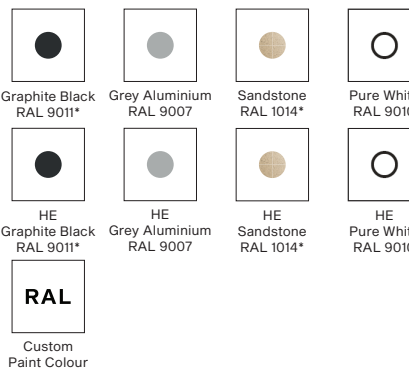

## OPTIC OPTIONS

### SYMMETRICAL

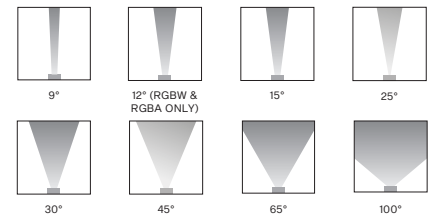

### BI-SYMMETRICAL

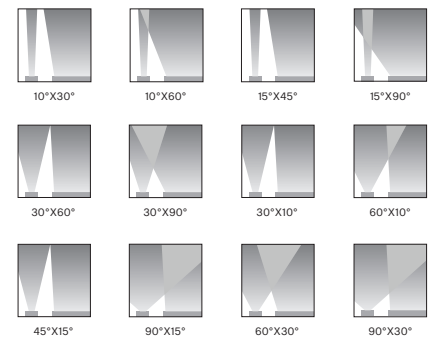

## STANDARD & SPECIFICATION

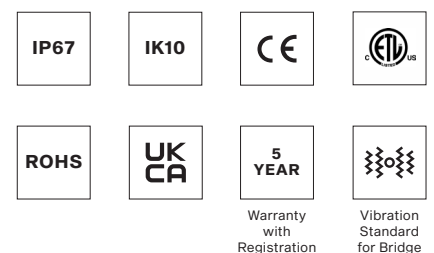

**SPECIFICATION**

<b>ELECTRICAL</b>	Typical Power Consumption	10 W		
	Input Voltage	48 V		
<b>OPTICAL</b>	Light Source	High Power Multichip LED		
	Colour Variants	RGBW (W - 6500 K)   RGBA   RGBL   Pure White (W - 3000 K) <b>On Request:</b> Tuneable White (3000–6500 K)		
	Beam Angle	9°   12° (RGBW & RGBA only)   15°   25°   30°   45°   65°   100°		
	Lumen Output Delivered	333 lm (@9°RGBW)		
	Projected Lumen Maintenance	L90B10 >90.000 hrs, Ta = 25°C / 77°F		
			10°x30°   30°x10°   10°x60°   60°x10°   15°x45°   45°x15° 15°x90°   90°x15°   30°x60°   60°x30°   30°x90°   90°x30°	
<b>CONTROL</b>	Interface protocol	Via E-box Remote or E-box Remote Basic		
	E-Box Remote control protocol	USITT DMX512/RDM, ArtNet, MA Net, MA Net2, sACN, Kling-Net		
	Setting / addressing	E-box Remote, RDM communicator		
	Connectivity & Power Supply	E-Box Remote   Remote Basic		
<b>PHYSICAL</b>	Width x Height x Depth	94 x 108 x 76 mm (3.7 x 4.2 x 2.99 in.)		
	Weight	0.59 kg   1.3 lbs		
	Housing	High Pressure Die-Cast Aluminium Body   Tempered Glass		
	Finish Options	Standard Colour	Graphite Black RAL 9011   Grey Aluminium RAL 9007 Pure White RAL 9010   Sandstone RAL 1014	
		Standard Colour Harsh Environment	Graphite Black RAL 9011   Grey Aluminium RAL 9007 Pure White RAL 9010   Sandstone RAL 1014	
		Cost Option	Custom RAL	
	Cabels / Connectivity	<b>IN (for DMX, DALI):</b> - 1 m cable with bare end - Other cable length - custom - Junction box - optional	<b>IN (for E-Box Version):</b> - Cable (5x20 AWG) 0.5m, with Connector MM	
	Mounting Method	Yoke or Yoke for Pole Adaptor		
	Adjustability	+180° / -180°		
	Protection Factor	IP67 (IP66 Junction Box) / Suitable For Wet Locations		
	IK Rating	IK10		
Cooling System	Convection			
Operating Ambient Temperature	-20°C / +50°C (-4°F / +122°F)			
<b>CERTIFICATION</b>	Listings	ETL / cETL, CE, RoHS, UKCA		
<b>ACCESSORIES</b>	Not Included Items	Optical Demo Set for Calumma XS (for demo purposes)		
		Outdoor Foil Holder for Calumma XS (for permanent installation)		
		Optical Foil Set for Outdoor Foil Holder Calumma XS		
		Re-enterable Electrical Insulating Resin		
		Land Spike for Calumma XS		
		Top Hat Calumma XS		
		Half Top Hat Calumma XS		
Twin Wall Cover Calumma XS				
Pole Adaptor (ø 102 mm) (Yoke for Pole Adaptor Required)				

	Junction Box Remote (1x Output) - (10980715)
	Junction Box Remote (4x Output) - (10980716)
<b>DMX BARE-END</b>	Cable SJTW 5x14 AWG (13053336), standard with bare-end, black - 1/3/5/10 m
	Cable SJTW 5x14 AWG (13053697), with bare-end, white (on request) - 1/3/5/10 m
	Cable UL 20969 (5x20 AWG), 1 m, (13053481), black
	Cable UL 20969 (5x20 AWG), 1 m, (13053696), white (on request)
	Leader Cable FF 0.1 m CE AD-05
	Jumper Cable MM/FFCE AD-05 0.5 m   1 m   3 m   5 m
<b>ACCESSORIES</b> Not Included Items	T-connector MINI-05 MFF (13053941-01)
	T-connector MID-05 MFF (13054130)
	Waterproof Cap for M connector AD-05
	Waterproof Cap for F connector AD-05
<b>DMX CONNECTOR SOLUTION</b>	Cable SJTW 5x14 AWG (black or white) - main connection between Junction Boxes
	Connection Box Remote 1x Out (14 AWG–20 AWG)
	Connection Box Remote 2x Out (14 AWG–14 AWG & 20 AWG)
	Field Installable Connector MID-05 MM (14–22 AWG) - (13054126)
	Adaptor MINI2MID (13054150)
	Adaptor MID2MINI (13054149)

## CONTROL AND CONNECTION OPTIONS - CE

### DMX - BARE-END CE

- 1) SJTW 5x14 AWG (13053693), Standard 1 m with bare-end, black or on request Cable SJTW 5x14 AWG (13053697), with bare-end, white
- 2) Junction Box Remote (4x Output)
- 3) Cable UL 20969 5x20 AWG (13053481), black or on request Cable UL 20969 5x20 AWG (13053696), white
- 4) Junction Box Remote (1x Output)

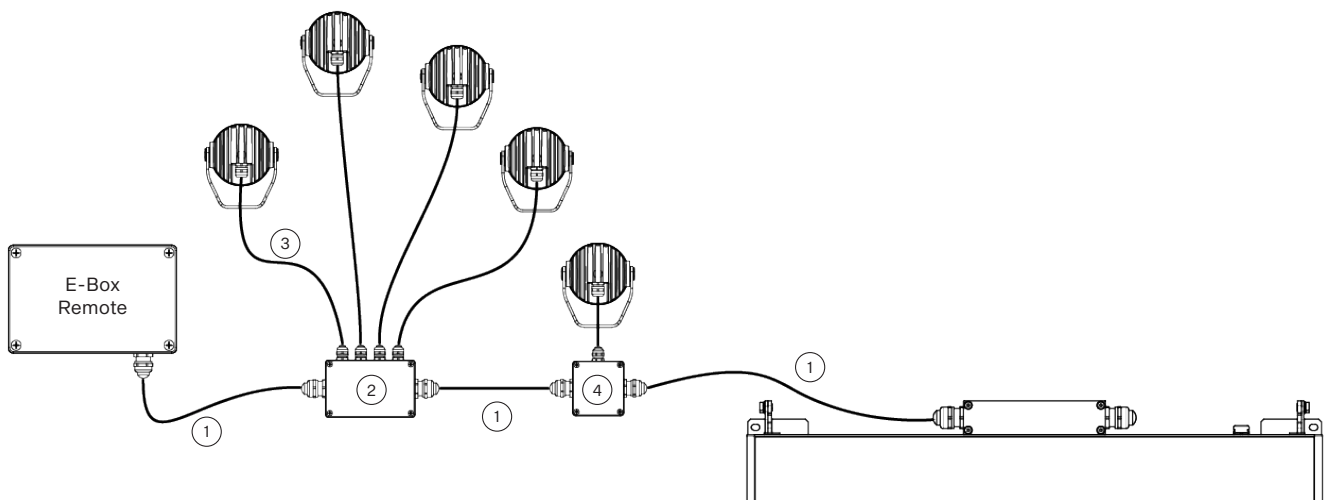

**CONTROL AND CONNECTION OPTIONS - CE**

**DMX - CONNECTOR SOLUTION**

**A E-BOX REMOTE / REMOTE BASIC / REMOTE BASIC MINI**

- 1) SJTW 5x14 AWG (13053336), standard with bare-end, black
- 2) Field Installable Connector MID-05 FF (14-22 AWG) - (13054127)
- 3) T-connector MID-05 MFF (13054130)
- 4) Jumper Cable CE/US MID-05 FF/MM (5x14 AWG), 0.5 m (13054131)
- 5) Adaptor MID2MINI (13054149)
- 6) Cable 5x20 AWG, 0.5 m, with connector MINI-05 MM (Lamari component)

**Note: The last unmated connector must be fitted with an Waterproof Cap to protect the IP rating.**

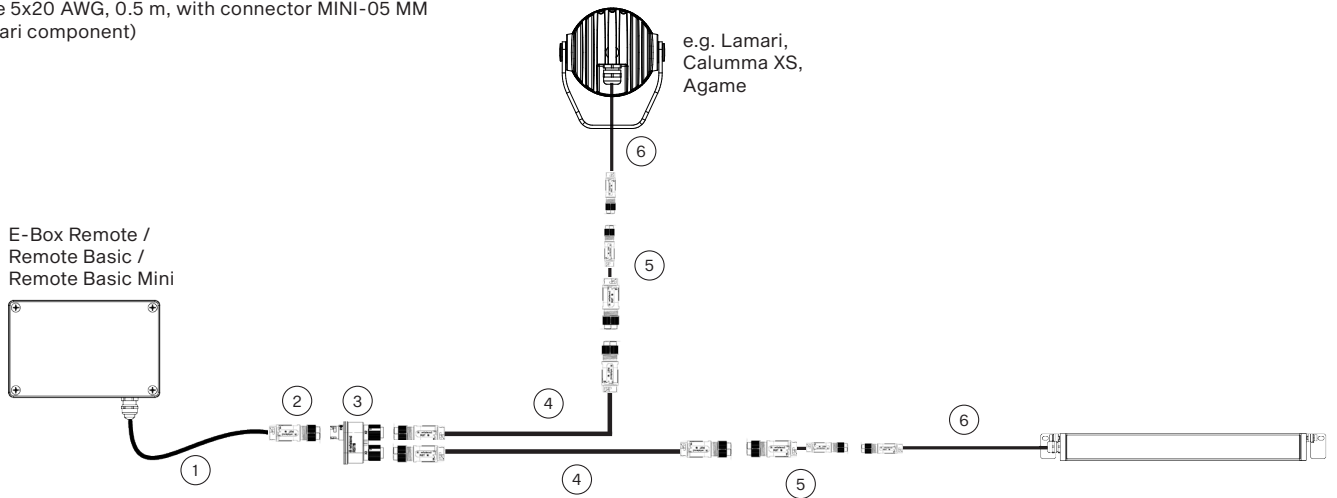

**B E-BOX REMOTE / REMOTE BASIC / REMOTE BASIC MINI WITH PANEL CONNECTORS**

- 1) Jumper Cable CE/US MID-05 FF/MM (5x14 AWG), 0.5 m (13054131)
- 2) Adaptor MID2MINI (13054149)
- 3) Jumper Cable MINI-05 FF/MM (20 AWG), 0.5 m (13053937-02)
- 4) T-connector MINI-05 MFF (13053941-01)
- 5) Cable 5x20 AWG, 0.5 m, with connector MINI-05 MM (Lamari component)

**Note: The last unmated connector must be fitted with an Waterproof Cap to protect the IP rating.**

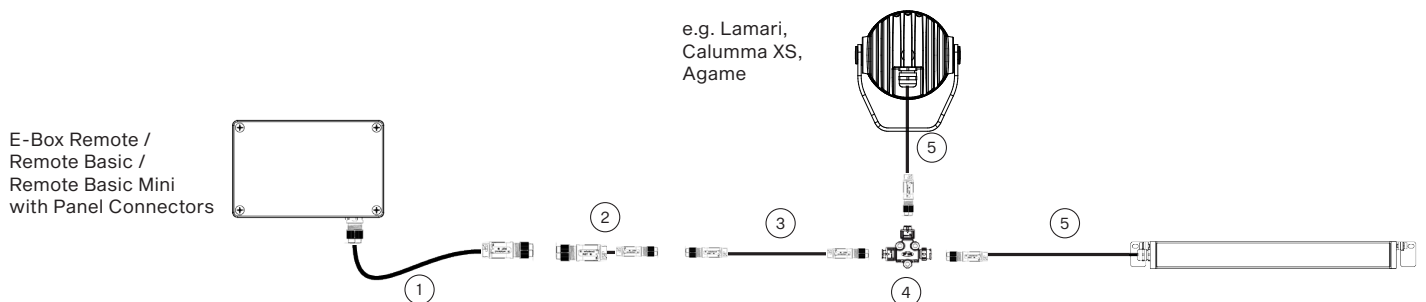

**CONTROL AND CONNECTION OPTIONS**

**DMX - BARE-END CE**

- 1) SJTW 5x14 AWG (13053336), standard with bare-end, black
- 2) Junction Box Remote (4x Output) - (10980716)
- 3) Cable UL 20969 (5x20 AWG), 1 m, (13053481), black

**Note: The last unmated connector must be fitted with an Waterproof Cap to protect the IP rating.**

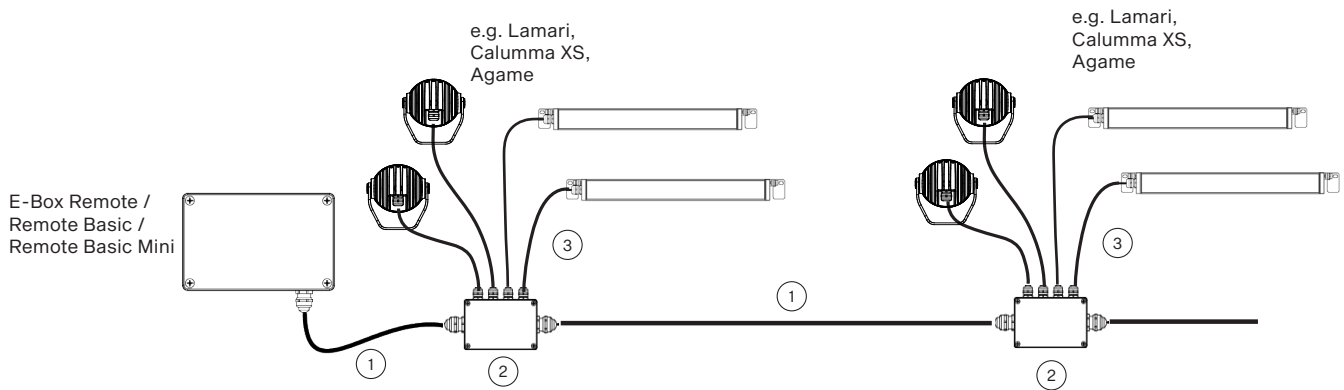

**ON/OFF**

- 1) Cable UL 20969 5x20 AWG (13053481), black  
or on request Cable UL 20969 5x20 AWG (13053696), white
- 2) Junction Box Remote (4x Output)
- 3) Junction Box Remote (1x Output)

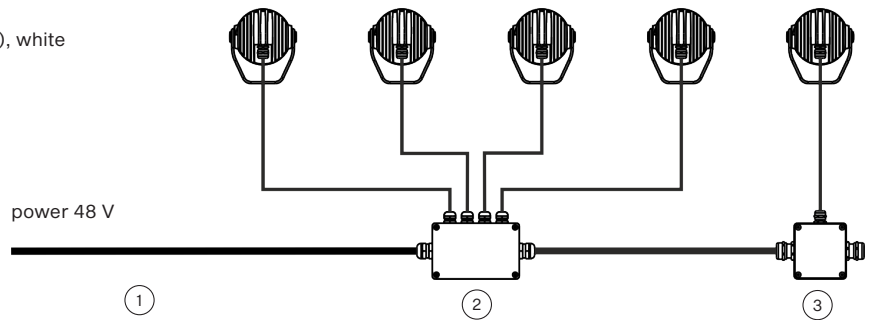

**CONNECTIVITY**

Following table shows maximum connected Calummas XS SC in a row with respect of cable length.

Cable length	Per E-Box Remote	Per 1 LED output
<b>50 m (max per 1 output)</b>	40 pcs	20 pcs
<b>100 m (total length, 2x output)</b>		20 pcs

PROJECTED AREA

	Front (rear) - m <sup>2</sup>	Front (rear) ft <sup>2</sup>	Side - m <sup>2</sup>	Side - ft <sup>2</sup>	Top - m <sup>2</sup>	Top - ft <sup>2</sup>
<b>Calumma XS</b>	0.006	0.065	0.007	0.070	0.006	0.065
<b>with Top Hat</b>	0.006	0.065	0.014	0.151	0.014	0.151
<b>with Half Top Hat</b>	0.006	0.065	0.008	0.082	0.014	0.151

DIMENSIONS

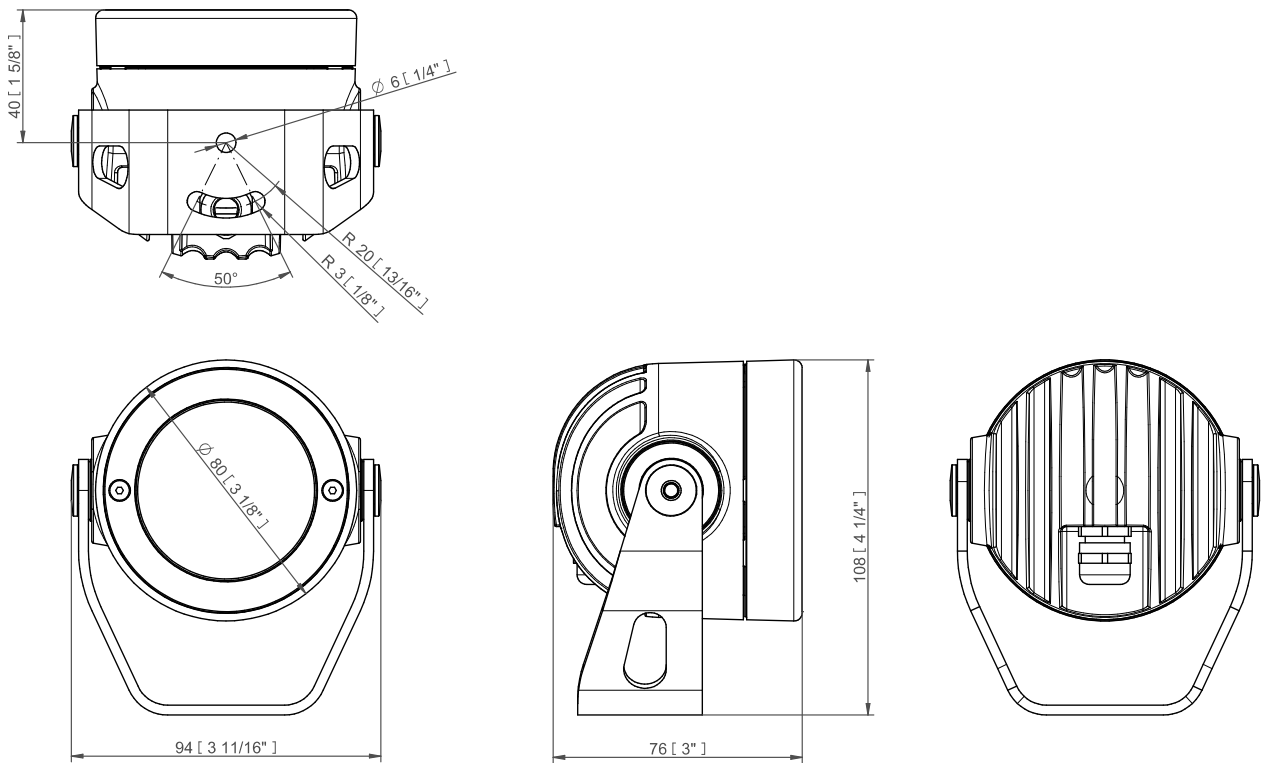

ACCESSORIES

Top Hat

Half Top Hat

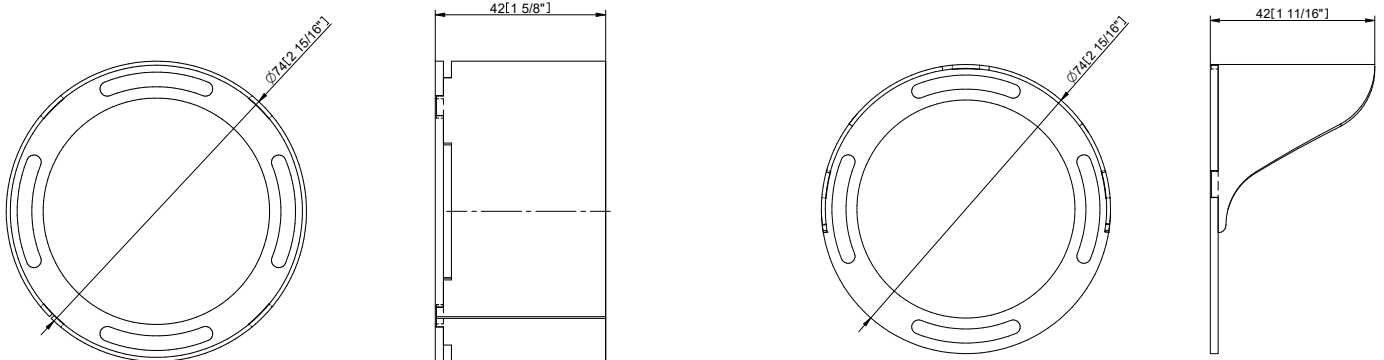

ACCESSORIES

Pole Adaptor (ø 102 mm, Yoke for pole Adaptor Required / PA)

Example of ordering code: Calumma XS MC RGBCW 15° PA

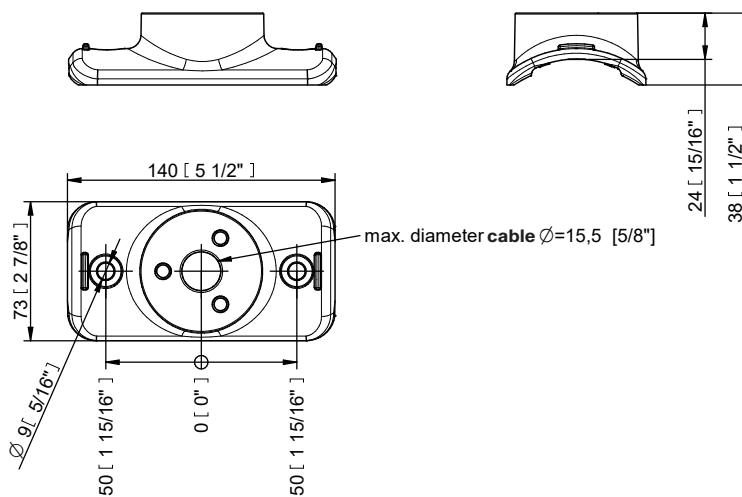

Land Spike for Calumma XS

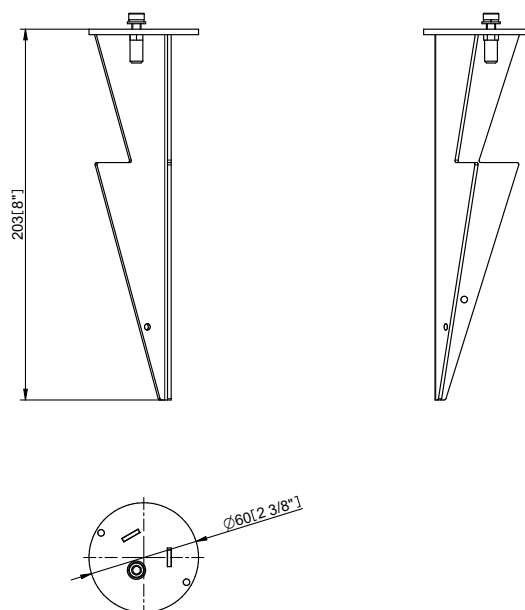

PHOTOMETRIC OVERVIEW

	Lumen Output (lm)		
	RGBCW (W 6500 K)	RGBA	WW (W 3000 K)
9°	333	285	283
12°	368	315	313
15°	283	243	241
25°	283	243	242
30°	278	238	237
45°	283	243	242
65°	283	243	242
100°	279	239	238
10° x 30°, 30° x 10°	267	229	228
10° x 60°, 60° x 10°	297	255	254
15° x 45°, 45° x 15°	303	259	258
30° x 60°, 60° x 30°	281	240	239
30° x 90°, 90° x 30°	302	258	257
15° x 90°, 90° x 15°	301	258	257

BI-SYMMETRICAL BEAM ANGLES

Bi-symmetrical:  
10°x30°,  
10°x60°,  
15°x45°,  
15°x90°,  
30°x60°,  
30°x90°

10°, 15°, 30°

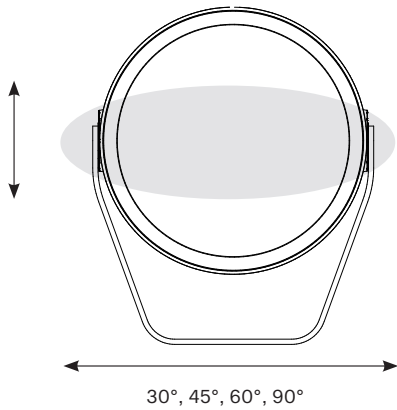

Bi-symmetrical:  
30°x10°,  
60°x10°,  
45°x15°,  
90°x15°,  
60°x30°,  
90°x30°

30°, 45°, 60°, 90°

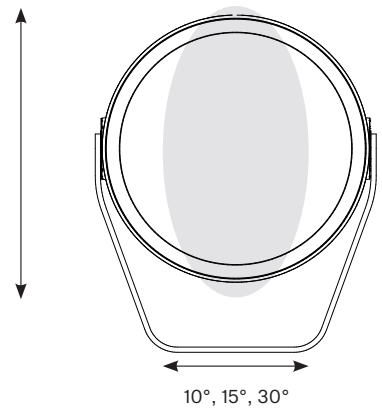

PHOTOMETRIC DATA

Calumma XS MC RGBW 6500K 9dg

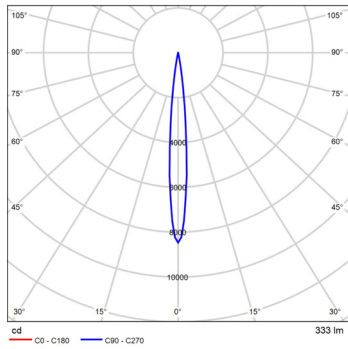

Calumma XS MC RGBW 6500K 12dg

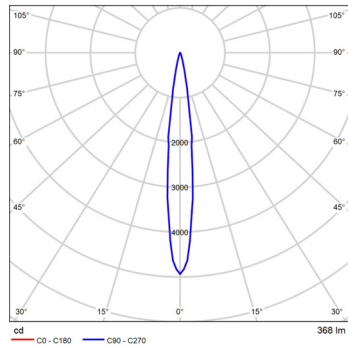

Calumma XS MC RGBW 6500K 15dg

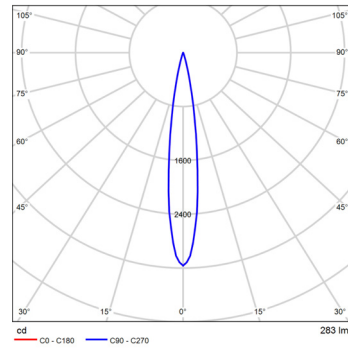

Calumma XS MC RGBW 6500K 25dg

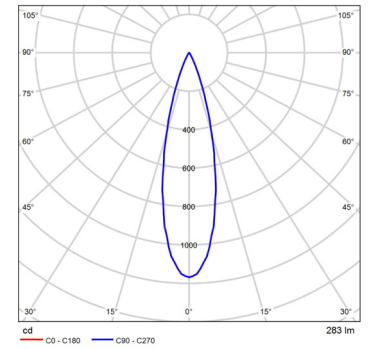

Distance [m]	Cone diameter [m]	Illuminance [lx]	E(0°) E(C0)
0.50	0.09	33876	5.0° 1846
1.0	0.17	8469	5.0° 4212
1.5	0.26	3764	5.0° 1872
2.0	0.35	2117	5.0° 1053
2.5	0.44	1358	5.0° 674
3.0	0.52	941	5.0° 468

Distance [m] Cone diameter [m] Illuminance [lx]  
C0 - C180 (Beam angle: 10.0°)

Distance [m]	Cone diameter [m]	Illuminance [lx]	E(0°) E(C0)
0.50	0.11	19730	6.3° 9748
1.0	0.22	4933	6.3° 2437
1.5	0.33	2192	6.3° 1083
2.0	0.44	1233	6.3° 609
2.5	0.55	789	6.3° 390
3.0	0.66	548	6.3° 271

Distance [m] Cone diameter [m] Illuminance [lx]  
C0 - C180 (Beam angle: 12.8°)

Distance [m]	Cone diameter [m]	Illuminance [lx]	E(0°) E(C0)
0.50	0.13	10657	7.6° 6165
1.0	0.27	2664	7.6° 1341
1.5	0.40	1406	7.6° 685
2.0	0.53	791	7.6° 385
2.5	0.67	558	7.6° 247
3.0	0.80	352	7.6° 171

Distance [m] Cone diameter [m] Illuminance [lx]  
C0 - C180 (Beam angle: 15.2°)

Distance [m]	Cone diameter [m]	Illuminance [lx]	E(0°) E(C0)
0.50	0.23	4873	13.0° 2172
1.0	0.46	1168	13.0° 543
1.5	0.69	519	13.0° 241
2.0	0.92	292	13.0° 136
2.5	1.2	187	13.0° 87
3.0	1.4	130	13.0° 65

Distance [m] Cone diameter [m] Illuminance [lx]  
C0 - C180 (Beam angle: 26.0°)

Calumma XS MC RGBW 6500K 30dg

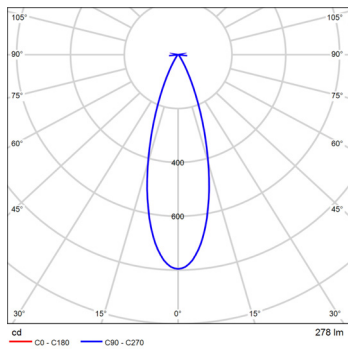

Calumma XS MC RGBW 6500K 45dg

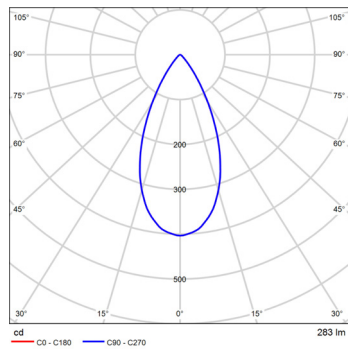

Calumma XS MC RGBW 6500K 65dg

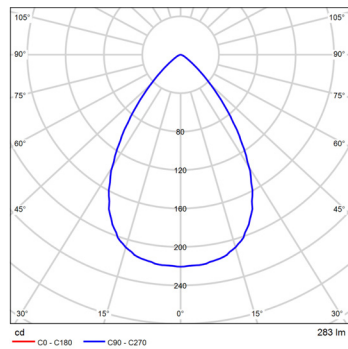

Calumma XS MC RGBW 6500K 100dg

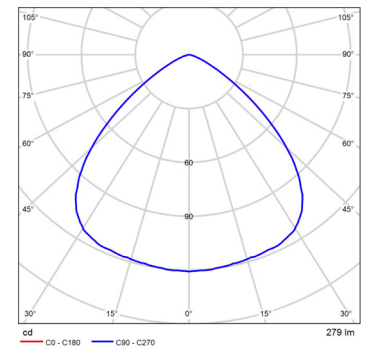

Distance [m]	Cone diameter [m]	Illuminance [lx]	E(0°) E(C0)
0.50	0.29	3183	16.0° 1428
1.0	0.57	796	16.0° 356
1.5	0.86	354	16.0° 158
2.0	1.1	199	16.0° 89
2.5	1.4	127	16.0° 57
3.0	1.7	88	16.0° 40

Distance [m] Cone diameter [m] Illuminance [lx]  
C0 - C180 (Beam angle: 32.0°)

Distance [m]	Cone diameter [m]	Illuminance [lx]	E(0°) E(C0)
0.50	0.45	1613	24.4° 610
1.0	0.91	403	24.4° 153
1.5	1.4	179	24.4° 68
2.0	1.8	101	24.4° 38
2.5	2.3	65	24.4° 34
3.0	2.7	45	24.4° 17

Distance [m] Cone diameter [m] Illuminance [lx]  
C0 - C180 (Beam angle: 48.8°)

Distance [m]	Cone diameter [m]	Illuminance [lx]	E(0°) E(C0)
0.50	0.70	882	34.9° 245
1.0	1.4	221	34.9° 61
1.5	2.1	98	34.9° 27
2.0	2.8	55	34.9° 15
2.5	3.5	35	34.9° 9.8
3.0	4.2	25	34.9° 6.8

Distance [m] Cone diameter [m] Illuminance [lx]  
C0 - C180 (Beam angle: 68.8°)

Distance [m]	Cone diameter [m]	Illuminance [lx]	E(0°) E(C0)
0.50	1.2	483	49.7° 66
1.0	2.4	121	49.7° 16
1.5	3.5	54	49.7° 7.3
2.0	4.7	30	49.7° 4.1
2.5	5.9	19	49.7° 2.6
3.0	7.1	13	49.7° 1.8

Distance [m] Cone diameter [m] Illuminance [lx]  
C0 - C180 (Beam angle: 99.4°)

PHOTOMETRIC DATA

Calumma XS MC RGBW 6500K  
10x30dg

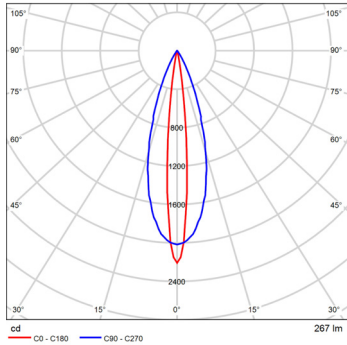

Distance [m]	Cone diameter [m]	E(0°)	E(C90)	E(C0)
0.50	0.35 0.09	8831	16.7° 3865	5.2° 4494
1.0	0.69 0.18	2208	16.7° 890	5.2° 1198
1.5	0.90 0.27	981	16.7° 396	5.2° 493
2.0	1.2 0.36	552	16.7° 233	5.2° 277
2.5	1.5 0.46	383	16.7° 142	5.2° 177
3.0	1.8 0.55	245	16.7° 99	5.2° 123

Distance [m]    Cone diameter [m]    Illuminance [lx]  
 C0 - C180 (Beam angle: 10.4°)    C90 - C270 (Beam angle: 33.4°)

Calumma XS MC RGBW 6500K  
10x60dg

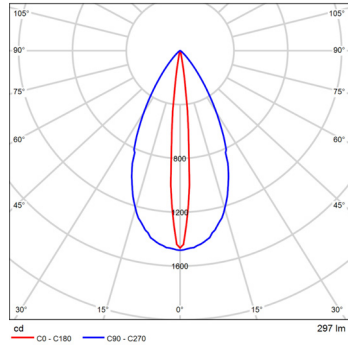

Distance [m]	Cone diameter [m]	E(0°)	E(C90)	E(C0)
0.50	0.50 0.11	5862	28.3° 2146	5.0° 2330
1.0	0.99 0.17	1466	28.3° 536	5.0° 792
1.5	1.5 0.26	691	28.3° 238	5.0° 338
2.0	2.0 0.35	366	28.3° 134	5.0° 183
2.5	2.5 0.44	234	28.3° 86	5.0° 117
3.0	3.0 0.52	163	28.3° 60	5.0° 81

Distance [m]    Cone diameter [m]    Illuminance [lx]  
 C0 - C180 (Beam angle: 10.0°)    C90 - C270 (Beam angle: 32.6°)

Calumma XS MC RGBW 6500K  
15x45dg

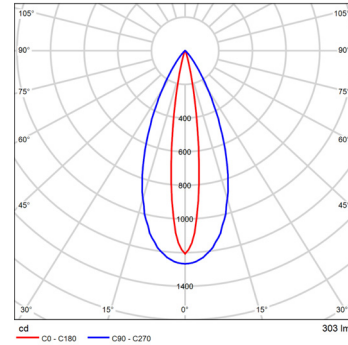

Distance [m]	Cone diameter [m]	E(0°)	E(C90)	E(C0)
0.50	0.45 0.14	4629	22.0° 2021	7.7° 2354
1.0	0.91 0.27	1207	22.0° 568	7.7° 589
1.5	1.2 0.41	537	22.0° 226	7.7° 262
2.0	1.6 0.54	302	22.0° 127	7.7° 147
2.5	2.0 0.68	193	22.0° 81	7.7° 94
3.0	2.4 0.81	134	22.0° 56	7.7° 65

Distance [m]    Cone diameter [m]    Illuminance [lx]  
 C0 - C180 (Beam angle: 15.4°)    C90 - C270 (Beam angle: 44.0°)

Calumma XS MC RGBW 6500K  
15x90dg

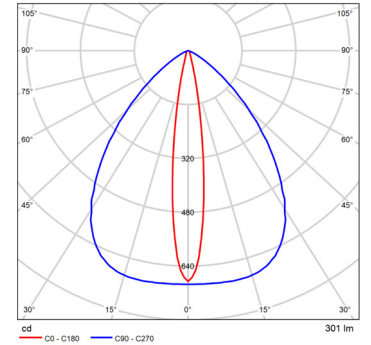

Distance [m]	Cone diameter [m]	E(0°)	E(C90)	E(C0)
0.50	0.80 0.13	2742	41.3° 363	7.6° 1301
1.0	1.6 0.27	686	41.3° 148	7.6° 338
1.5	2.4 0.40	305	41.3° 66	7.6° 150
2.0	3.2 0.53	171	41.3° 37	7.6° 84
2.5	4.0 0.67	110	41.3° 24	7.6° 54
3.0	4.8 0.80	76	41.3° 16	7.6° 38

Distance [m]    Cone diameter [m]    Illuminance [lx]  
 C0 - C180 (Beam angle: 15.2°)    C90 - C270 (Beam angle: 82.6°)

Calumma XS MC RGBW 6500K  
30x60dg

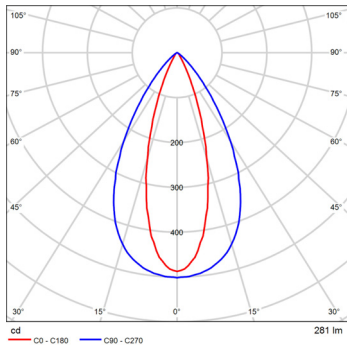

Distance [m]	Cone diameter [m]	E(0°)	E(C90)	E(C0)
0.50	0.58 0.28	1950	29.9° 855	15.7° 871
1.0	1.2 0.56	488	29.9° 164	15.7° 218
1.5	1.7 0.84	217	29.9° 73	15.7° 97
2.0	2.3 1.1	122	29.9° 41	15.7° 54
2.5	2.9 1.4	78	29.9° 26	15.7° 35
3.0	3.5 1.7	54	29.9° 18	15.7° 24

Distance [m]    Cone diameter [m]    Illuminance [lx]  
 C0 - C180 (Beam angle: 31.4°)    C90 - C270 (Beam angle: 58.6°)

Calumma XS MC RGBW 6500K  
30x90dg

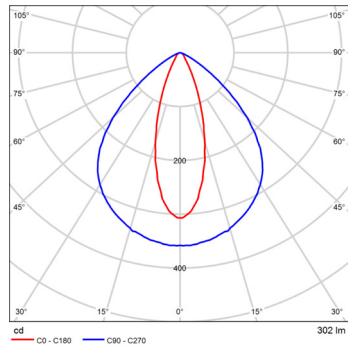

Distance [m]	Cone diameter [m]	E(0°)	E(C90)	E(C0)
0.50	1.0 0.30	1227	45.3° 290	16.8° 339
1.0	2.0 0.60	307	45.3° 63	16.8° 135
1.5	3.0 0.91	136	45.3° 28	16.8° 60
2.0	4.0 1.2	77	45.3° 16	16.8° 34
2.5	5.1 1.5	49	45.3° 10	16.8° 22
3.0	6.1 1.8	34	45.3° 6.9	16.8° 15

Distance [m]    Cone diameter [m]    Illuminance [lx]  
 C0 - C180 (Beam angle: 15.4°)    C90 - C270 (Beam angle: 50.6°)