

EMINERE® INGROUND 1 / 2 / 4 MC

Eminere Inground MC is a robust luminaire designed to be installed into the ground. A stainless steel installation sleeve provides rust protection as well as “armour” for the Eminere fixture itself. Overall, Eminere Inground MC comes with an IP67 protection factor, standard or Anti-skid glass, and as always, perfect colour mixing. With $\pm 15^\circ$ tilt adjustment, precision optics with wide range of beam angles and colour variants, in-ground version of the Eminere MC luminaire is great choice for an exterior applications such as flood lighting, wall grazing, wall washing and accent lighting.



KEY FEATURES

Application

Anti-skid glass option for pedestrian areas application. Easy to install into soft and hard ground.

Light Source

Full spectral LEDs selection with custom option on request. Output up to 1876 lm for Eminere Inground 2 MC (@12°, RGB-CW). Long LED lifetime over 90,000 hrs. Manually adjustable tilt 0° - 15° for fine adjustment of light beam.

Durability

High durability with ingress factor of IP67 and walkover housing for highest durability requirements.

COLOURS

* UPON REQUEST



RGBW
(6500 K)



RGBA



RGBL



PW
(3000 K)



TW
(3000-6500 K) *

CONTROL & PROTOCOLS



VIA
E-BOX
OPTIONAL



WIRELESS
DMX
OPTIONAL



DALI
OPTIONAL



NFC
OPTIONAL

FINISH OPTIONS

* CLOSEST RAL TONE
* HE = Harsh Environment



Graphite Black
RAL 9011*



HE
Graphite Black
RAL 9011*

SLEEVE & COVER PLATES



Stainless
Steel

OPTIC OPTIONS

SYMMETRICAL



12°



15°



25°



30°



45°



65°



100°

BI-SYMMETRICAL



10°x30°



10°x60°



15°x45°



15°x90°



35°x60°



30°x90°

STANDARD & SPECIFICATION



IP67



IK10



CE



ETL
US



ROHS



UK
CA



5
YEAR

Warranty
with
Registration



Vibration
Standard
for Bridge

SPECIFICATION

ELECTRICAL	Input Voltage	120–277 V AC 50/60 Hz		
	Typical Power Consumption	Eminere Inground 1: 30 W	Eminere Inground 2: 50 W	Eminere Inground 4: 90 W
OPTICAL	Light Source	High Power Multi Chip LEDs		
	Colour Variants	RGBW (W - 6500 K) RGBA RGBL Pure White (W - 3000 K)		
		On Request: Tuneable White (3000–6500 K)		
	Beam Angle	Symmetrical	Clear Glass: 12° 15° 25° 35° 45° 65° 100°	
			Anti-Skid: 18° 22° 35° 50° 65° 100° PRELIMINARY	
		Bi-symmetrical	Clear Glass: 10°x30° 10°x60° 15°x45° 15°x90° 35°x60° 30°x90°	
			Anti-Skid: 20°x35° 20°x65° 20°x90° 40°x70° PRELIMINARY	
	Lumen Output Delivered	Asymmetrical	Wallwasher	
Eminere Inground 1 MC		938 lm, (12°, @RGBCW, Clear Glass) 1.011 lm, RGBW @ 18° (Anti-Skid) PRELIMINARY		
Eminere Inground 2 MC		1876 lm, (12°, @RGBCW, Clear Glass) 2.021 lm, RGBW @ 18° (Anti-Skid) PRELIMINARY		
	Eminere Inground 4 MC	3752 lm, (12°, @RGBCW, Clear Glass) 4.042 lm, RGBW @ 18° (Anti-Skid) PRELIMINARY		
Projected Lumen Maintenance	L90B10 >90.000 hrs, Ta = 25°C / 77°F			
CONTROL	Interface Protocol	Via E-Box range Wireless DMX NFC DALI 2		
	E-Box Control Protocols	USITT DMX512, RDM, ArtNet, MA Net, MA Net2, sACN, Kling-Net		
	Wireless DMX (Option)	Lumen Radio CRMX Technology		
	Setting / Addressing	Via Two Row LCD Display with Control Buttons or RDM communicator NFC (Stand-alone)		
	Power Supply	Integrated		
	Connectivity	E-box Lite	Max. 32 pcs of Eminere Inground 1/ 2 / 4 MC	
PHYSICAL	Width x Height x Length	Eminere Inground 1 / 2 / 4:	186 x 228 x 407 / 707 / 1307 mm (7.32 x 8.98 x 16.02 / 27.83 / 51.46 in.)	
	Weight	12.8 kg / 28.2 lbs	(8.5 kg / 18.7 lbs Eminere Inground 1 MC Fixture , (5.5 kg / 12.1 lbs Install. Sleeve)	
		19.6 kg / 43.2 lbs	(12 kg / 26.4 lbs Eminere Inground 2 MC Fixture , 9.5 kg / 20.9 lbs Install. Sleeve)	
		35.4 kg / 78.1 lbs	(21 kg / 46.2 lbs Eminere Inground 4 MC Fixture , 18.7 kg / 41.1 lbs Install. Sleeve)	
	Housing	High Pressure Extruded Aluminium Body End Caps - Die-Cast Aluminium Tempered Glass		
		Anti-Skid (Option) Stainless Steel Installation sleeve for pre-installation		
	Finish Options	Fixture	Graphite Black RAL 9011 Harsh Environment Graphite Black RAL 9011 (Cost option)	
		Sleeve & Cover Plates	Stainless Steel	
	Connections	Junction Box		
Mounting Method	Inground mount			
Adjustability	Tilt 0°–15° (except Wallwasher version)			
Protection Factor (IP IK)	IP67 / Suitable For Wet Locations	IK10		
Max. Static Load	Standard Tempered Glass: 45kN	Anti-Skid Tempered Glass: 23kN		
Cooling System	Convection			
Operating Ambient Temperature	-20°C / +50°C (-4°F / +122°F)			
Operating Temperature	+80°C @ Ambient +40°C (+176°F @ Ambient +104°F)			
CERTIFICATION	Listings	ETL / cETL, CE, RoHS, UKCA		
	Anti - Skid Glass Certification	UNE ENV12633 (Class 3), DIN 51130 (R-12), DIN 51097 (Class B), ASTM C 1028-07 (DRY: ≥ 0,7, WET: ≥ 0,6), EN101:91 MOHS (4-Point scale)		

SPECIFICATION

Not Included Items	
ACCESSORIES	Mounting
	Eminere Inground Mounting Sleeve
	Eminere Inground Cover Plate Continuous (incl. 1x Cover Plate Middle)
	Eminere Inground Cover Plate End
	Eminere Inground Trim StandAlone
	Junction Box for Eminere Inground
Cables & Connectors	
Insulation Re-enterable Electrical Insulating Resin	
Cable CE WCA Cable US WCA	

DIMENSIONS

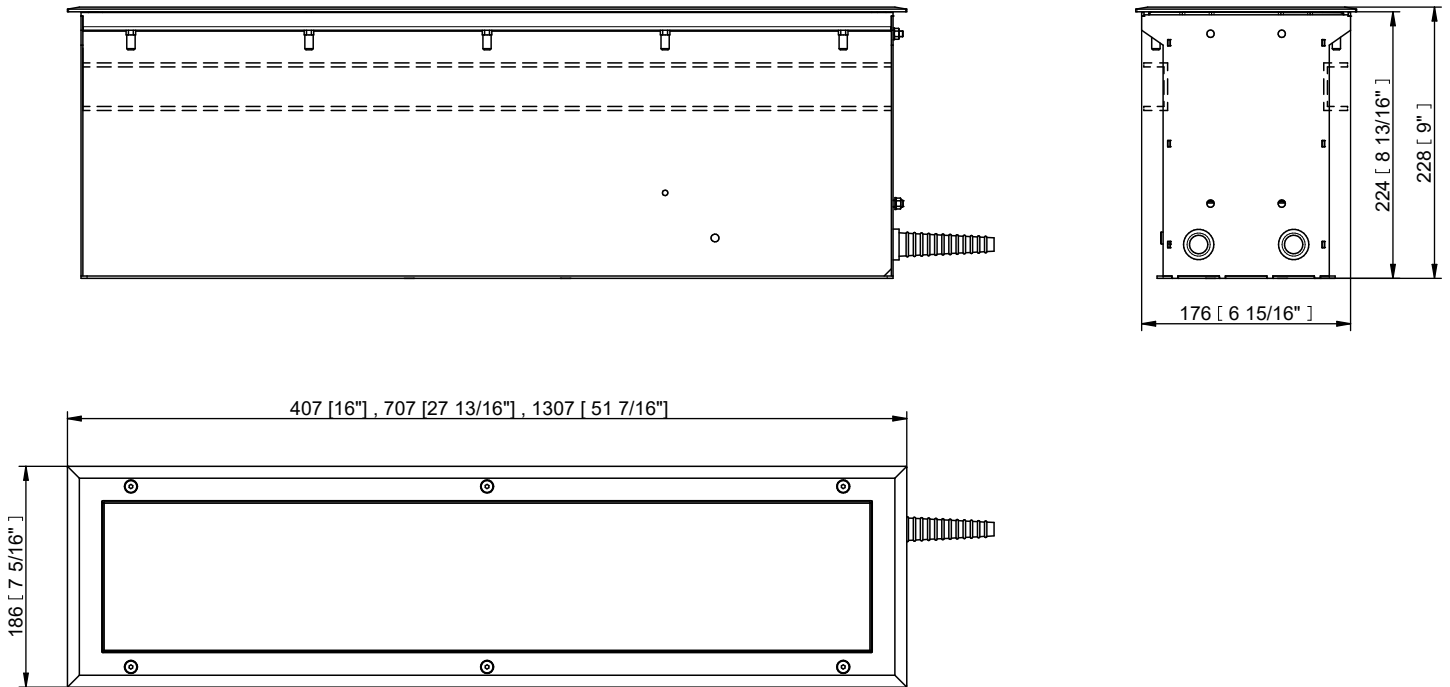

PHOTOMETRIC OVERVIEW

Based on RGBCW (CLEAR GLASS) version, all leds @ full

Lumen Output (lm)

	EMINERE INGROUND 1 MC	EMINERE INGROUND 2 MC	EMINERE INGROUND 4 MC
12°	938	1876	3752
15°	868	1736	3472
25°	870	1739	3478
35°	871	1741	3482
45°	865	1729	3458
65°	996	1728	3456
100°	837	1673	3346
10° x 30°	871	1741	3482
10° x 60°	853	1705	3410
15° x 45°	876	1752	3504
15° x 90°	864	1727	3454
30° x 90°	846	1691	3382
35° x 60°	860	1719	3438

COLOUR MIXING PRINTS

STAND ALONE Specially designed glass printing to achieve optimal colour mixing and intensity distribution.

SYMMETRICAL

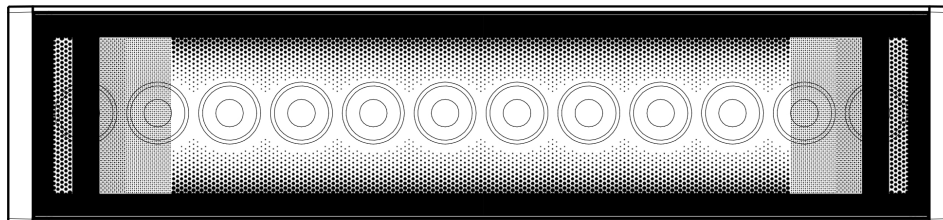

WALLWASHER

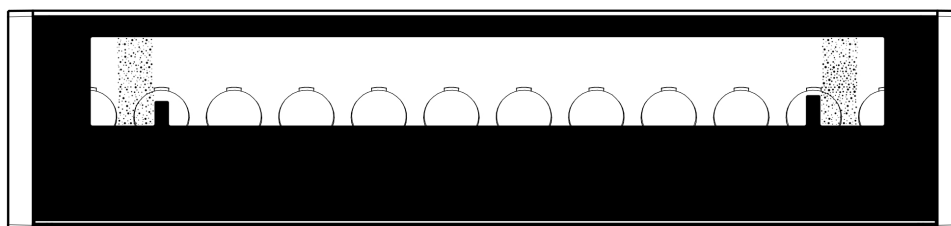

Note: Applies for RGBW, RGBA versions. Pure white and Tunable white versions are always without the end print (no matter on their position to other fixture).

BY-SYMMETRICAL OPTIC OPTIONS

Bi-symmetrical: 10°x30°, 10°x60°, 35°x70°, 15°x90°

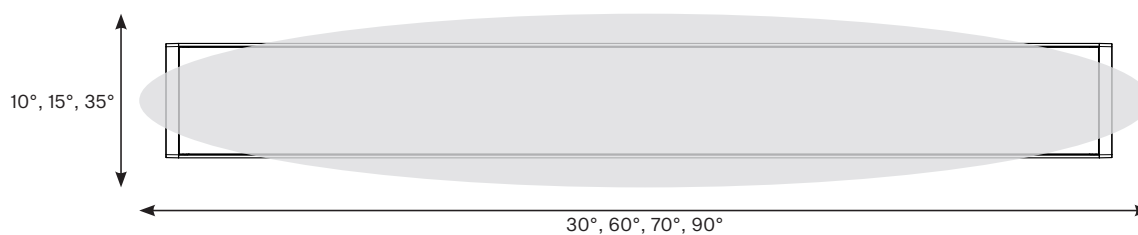

E-BOX SPECIFICATION

ELECTRICAL	Input Voltage	120–277 V AC 50/60 Hz		
	Wireless DMX (Option)	Lumen Radio CRMX Technology		
	Interface Protocol	E-box Lite: USITT DMX512, RDM		
		E-box Daisy / Star: USITT DMX512, RDM, ArtNet, MA Net, MA Net2, sACN, Kling-Net		
Operating Modes	E-box Lite / Daisy: Fixture Mode, Pixel Mode, Output Mode			
	E-Box Star: Total Mode, Fixture Mode, Pixel Mode, Output Mode			
CONTROL	Display	Via Two Row LCD Display with Control Buttons or RDM communicator		
	Control System	E-box With Self Addressing Feature or Custom Setting Via LCD Display/RDM		
	Power Supply	Integrated		
	Connectivity	E-box Lite	144 of Eminere 1 (@ 230 V and 40m cable) via 1 Output	
		E-box Daisy	144 of Eminere 1 (@ 230 V and 40m cable) via 1 Output	
		E-box Star	144 of Eminere 1 (@ 230 V and 40m cable) via 6 Outputs	
	Length x Width x Height	E-box Lite	220 x 120 x 81 mm (8.66 x 4.72 x 3.18 in.)	
		E-box Daisy	260 x 160 x 91 mm (10.24 x 6.30 x 3.58 in.)	
		E-box Star	280 x 230 x 111 mm (11.02 x 9.06 x 4.37 in.)	
	Weight	1.67 kg 3.85 lbs	2.78 kg 6.13 lbs	4.4 kg 9.7 lbs
Housing	Die-Cast Aluminium Case			
PHYSICAL	Finish Options	Standard Colour	Graphite Black RAL 9011 Grey Aluminium RAL 9007 Pure White RAL 9010 Sandstone RAL 1014	
		Harsh Environment	Graphite Black RAL 9011 Grey Aluminium RAL 9007 Pure White RAL 9010 Sandstone RAL 1014	
	Cost Options	Custom RAL		
Cables / Connections	Cable Grommet (stainless steel)			
Mounting Method	Surface Mount , 4 Mounting Holes			
Protection Factor	IP67 / Suitable For Wet Locations			
IK Rating	IK10			
Cooling System	Convection			
Operating Ambient Temperature	-20 °C / +40 °C (-4 °F / +104 °F)			
CERTIFICATION	Listings	ETL / cETL, CE, RoHS, UKCA		

COMPARISON

	E-BOX LITE	E-BOX DAISY	E-BOX STAR
Power input	1	1	1
Fixture Output	1	1	6
Total load (current)	16A	16A	16A
DMX control	YES	YES	YES
RDM	YES	YES	YES
Art-Net	NO	YES	YES
Ethernet switch	NO	YES	YES
Kling-Net	NO	YES	YES
sACN	NO	YES	YES
MA Net, MA Net2	NO	YES	YES

E-BOX DIMENSIONS

E-BOX LITE

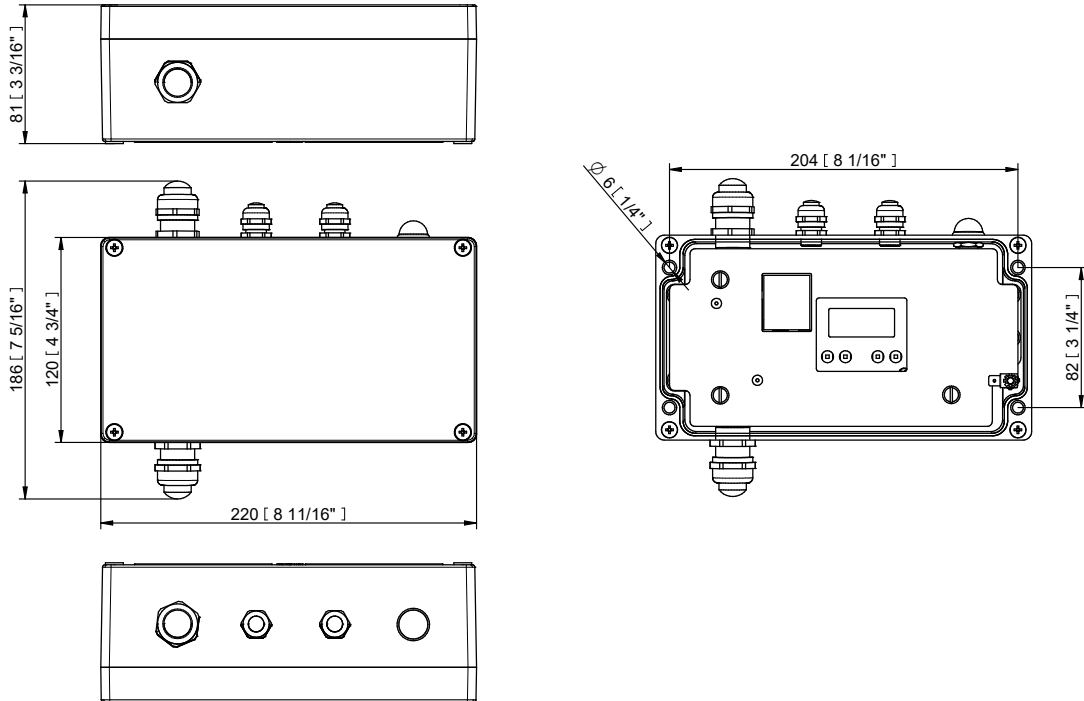

E-BOX DAISY

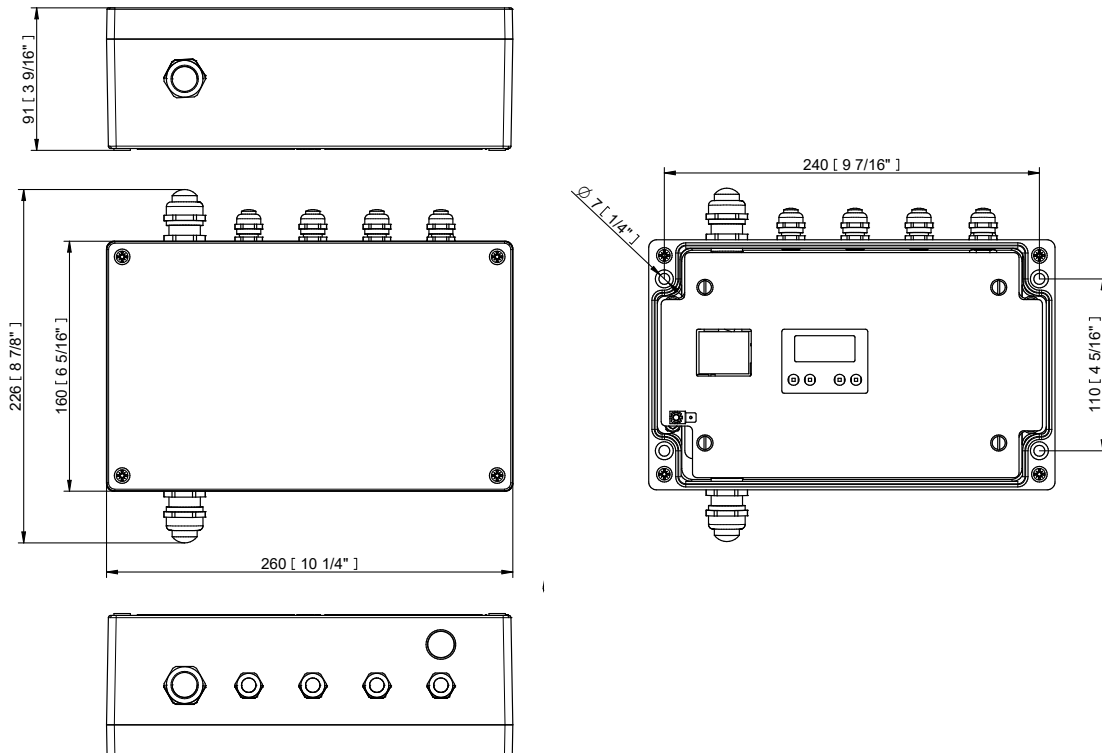

E-BOX STAR

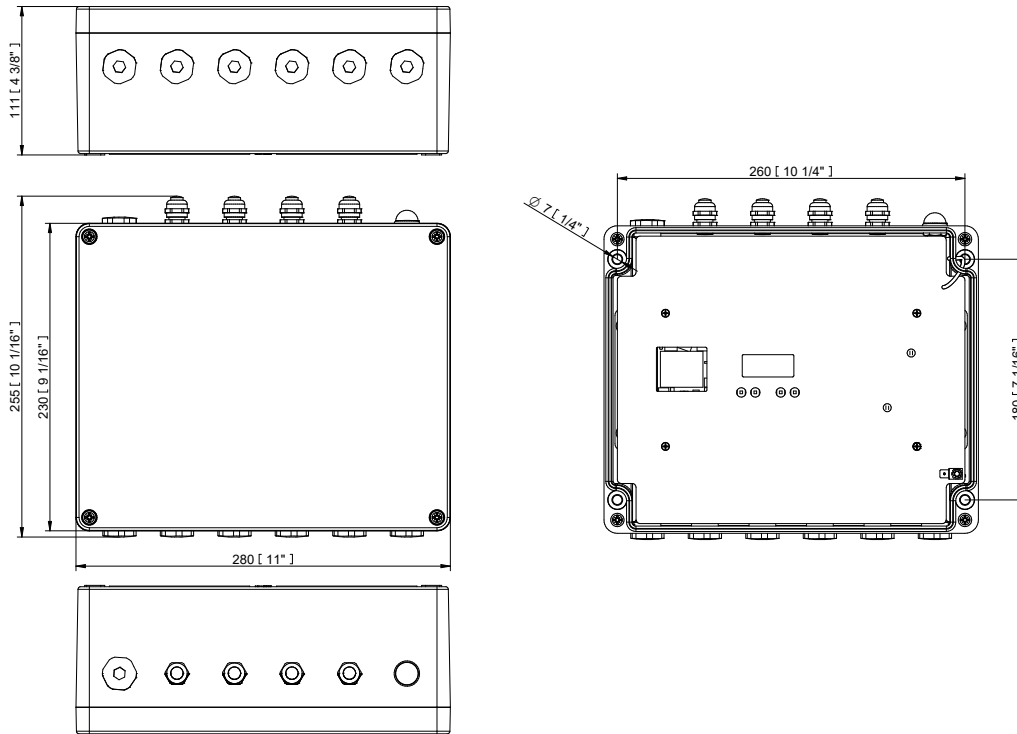

CONNECTIVITY

Following table shows maximum connected Emineres on each output of E-Box with respect of cable length.

	Cable length (m)	Voltage (V)			
		120	190	230	277
EMINERE INGROUND 2 MC	10	32	32	32	32
	20	32	32	32	32
	30	28	32	32	32
	50	17	32	32	32
	70	12	31	32	32
	100	9	21	32	32

	Cable length (m)	Voltage (V)			
		120	190	230	277
EMINERE INGROUND 4 MC	10	21	32	32	32
	20	21	32	32	32
	30	15	32	32	32
	50	9	22	32	32
	70	6	16	23	32
	100	4	11	16	23

Please read the E-boxes user manuals for more information about their setting.

Important: the item "E-box mode" has to be set at "Pass Thr" (Personality - E-box mode - Pass Thr).

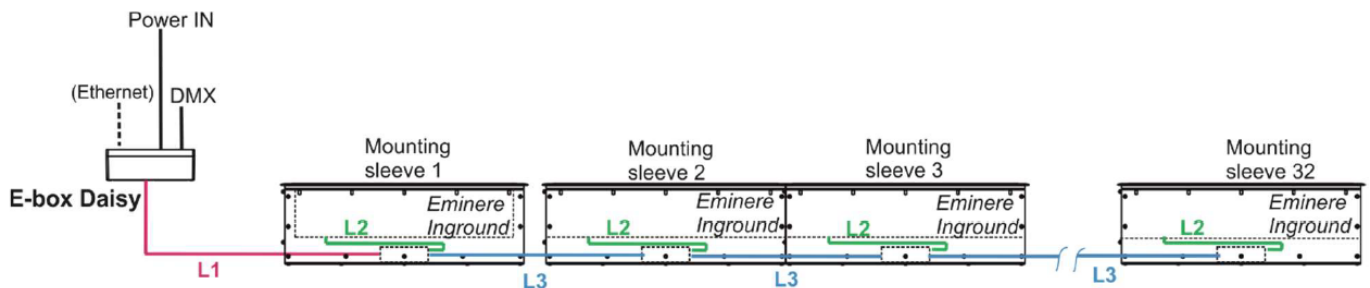

MOUNTING ACCESSORIES (ORDER SEPARATELY)

Mounting sleeve

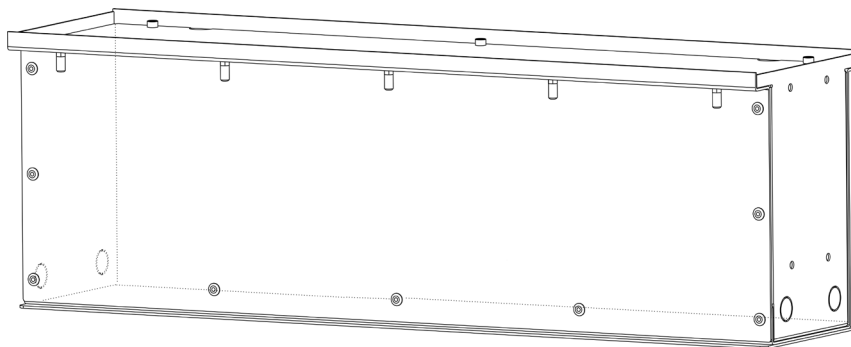

Cover Plates

Two types of Cover Plates must be ordered separately, depending on installation option:

- Cover Plate Continuous (includes set of 2pcs)
- Cover Plate End (includes set of 2pcs)

Examples:



Cover plate set-up for STAND ALONE option (consist of 1x set of Cover Plate Continuous and 1x set of Cover Plate End).
Cover Plate Continuous is always packed together with 1x Cover Plate Middle.

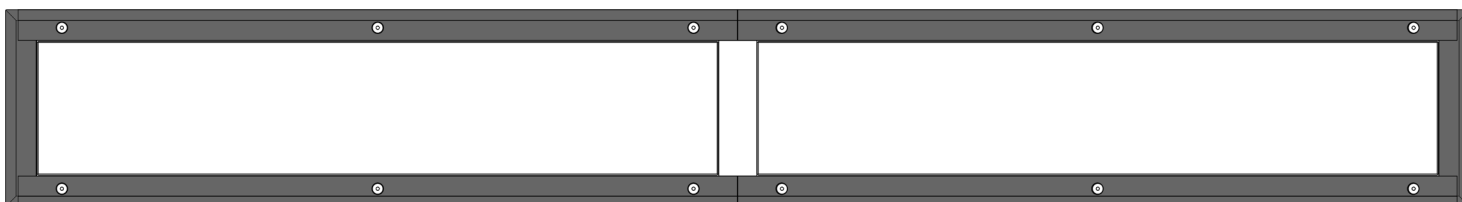

Cover plate set-up for HEAD2HEAD connection option (consist of 2x set of Cover Plate Continuous, 1x Cover Plate Middle and 1x set of Cover Plate End).
Cover Plate Continuous is always packed together with 1x Cover Plate Middle.

PHOTOMETRIC DATA

Eminere Inground 4 MC RGBCW
Clear Glass 9dg

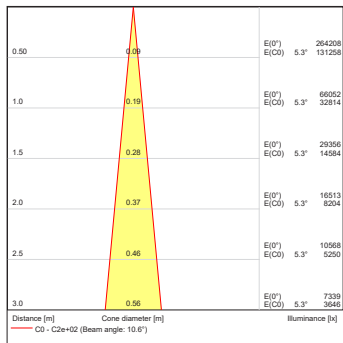
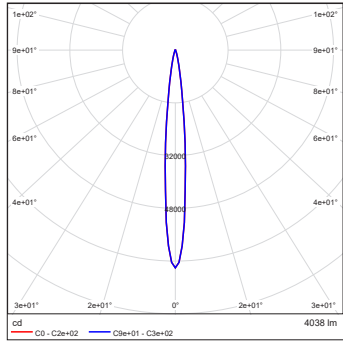

Eminere Inground 4 MC RGBCW
Clear Glass 15dg

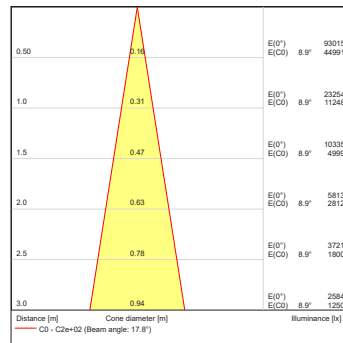
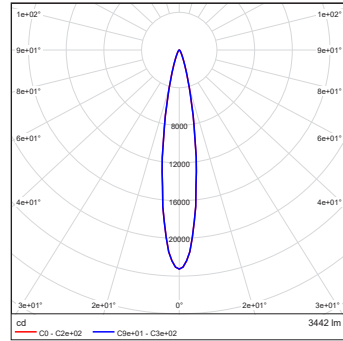

Eminere Inground 4 MC RGBCW
Clear Glass 30dg

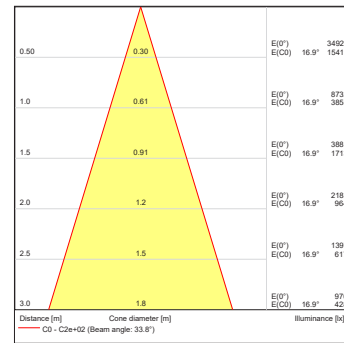
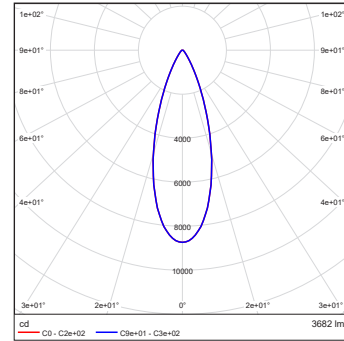

Eminere Inground 4 MC RGBCW
Clear Glass 50dg

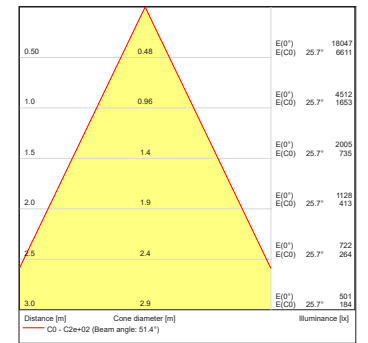
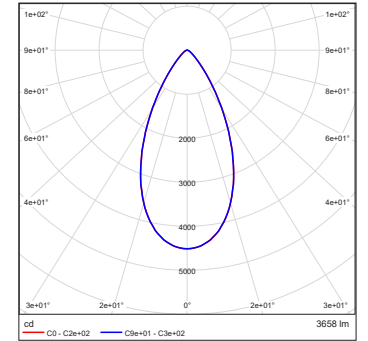

Eminere Inground 4 MC RGBCW
Clear Glass 65dg

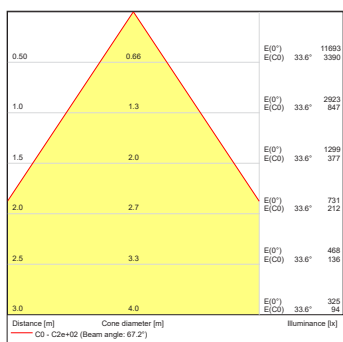
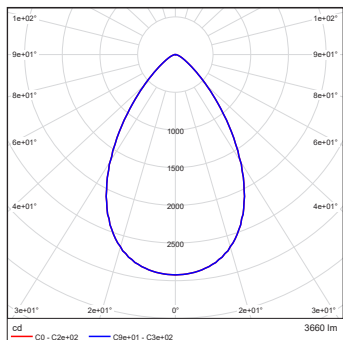

Eminere Inground 4 MC RGBCW
Clear Glass 100dg

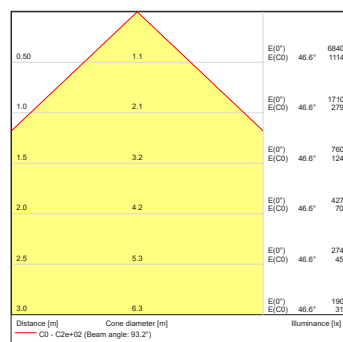
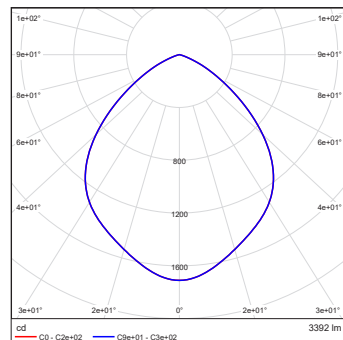

PHOTOMETRIC DATA

Eminere Inground 4 MC RGBCW
Clear Glass 10dg x 30dg

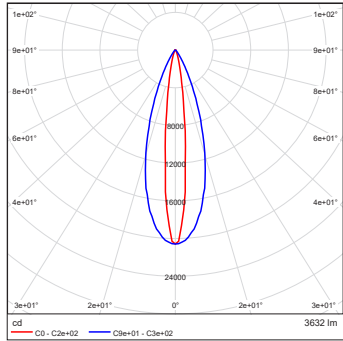

Eminere Inground 4 MC RGBCW
Clear Glass 10dg x 60 dg

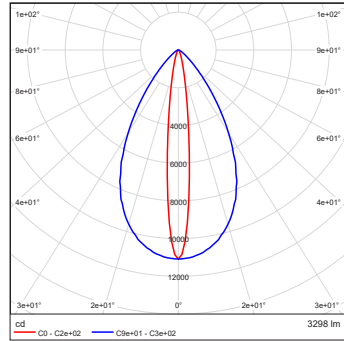

Eminere Inground 4 MC RGBCW
Clear Glass 35dg x 70dg

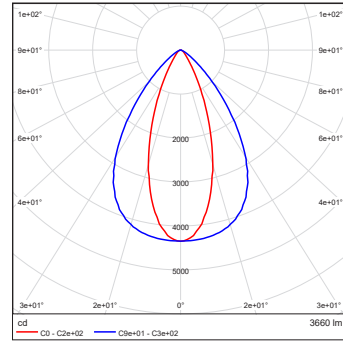

Eminere Inground 4 MC RGBCW
Clear Glass 15dg x 90dg

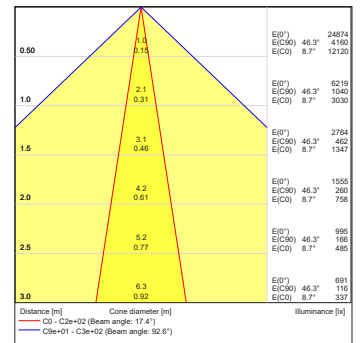
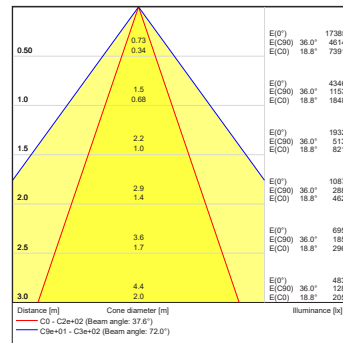
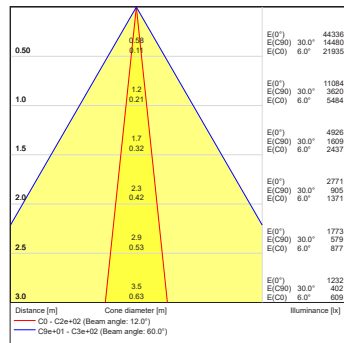
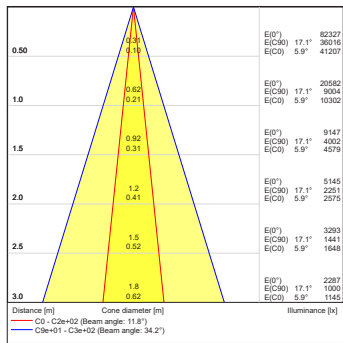
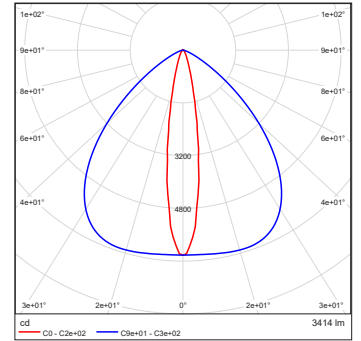

Eminere Inground 4 MC RGBCW
Clear Glass WallWasher

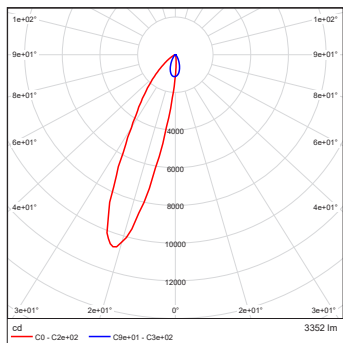

Eminere Inground 4 MC RGBCW
Clear Glass Wide WallWasher

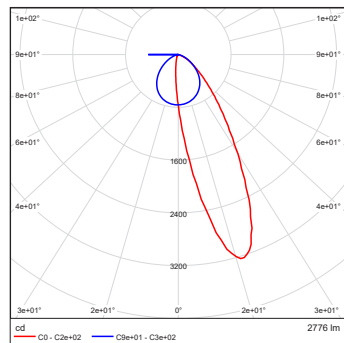

PHOTOMETRIC DATA

Eminere Inground 4 MC RGBCW
Anti-Skid Glass 18dg

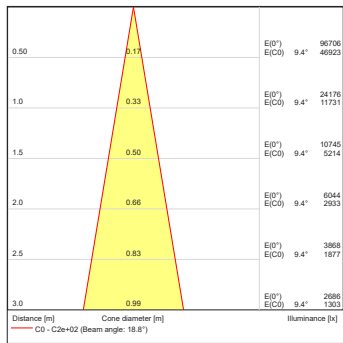
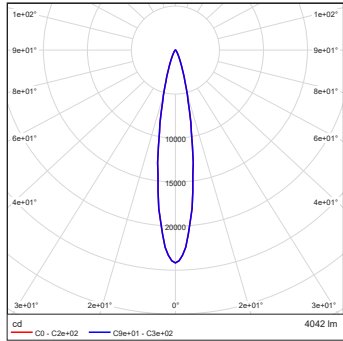

Eminere Inground 4 MC RGBCW
Anti-Skid Glass 22dg

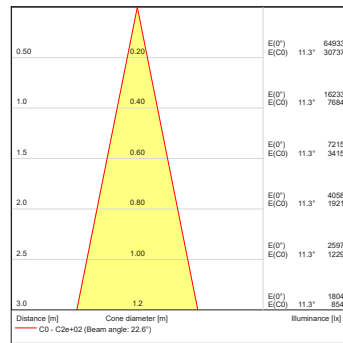
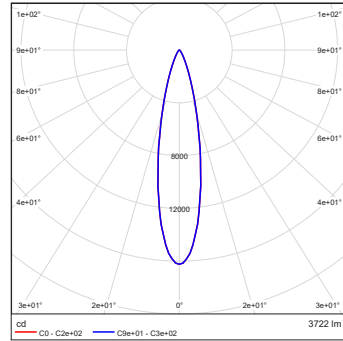

Eminere Inground 4 MC RGBCW
Anti-Skid Glass 35dg

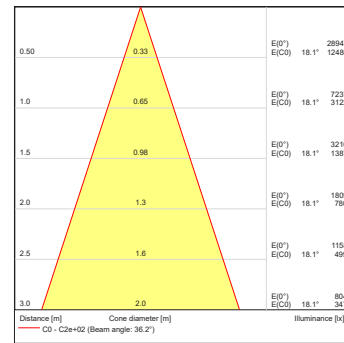
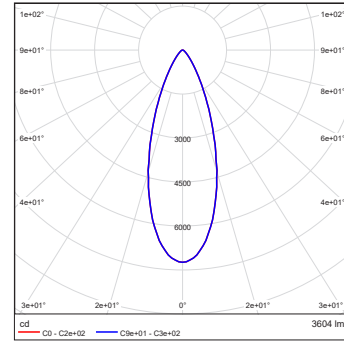

Eminere Inground 4 MC RGBCW
Anti-Skid Glass 50dg

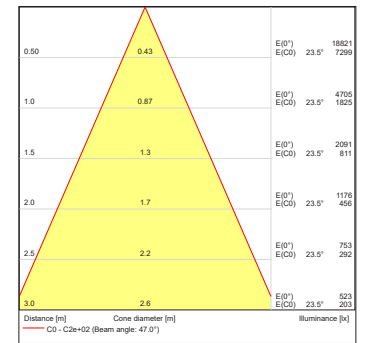
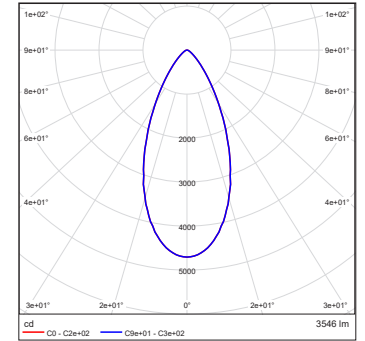

Eminere Inground 4 MC RGBCW
Anti-Skid Glass 65dg

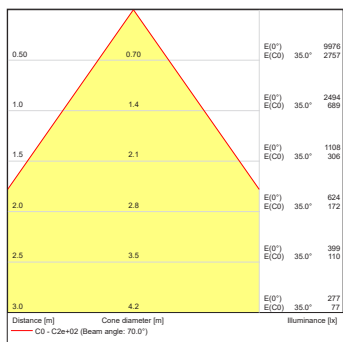
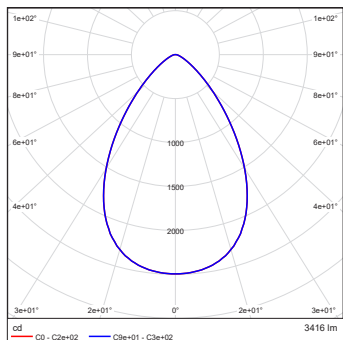

Eminere Inground 4 MC RGBCW
Anti-Skid Glass 100dg

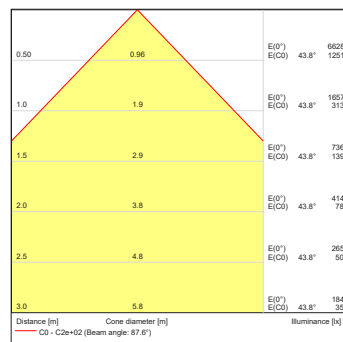
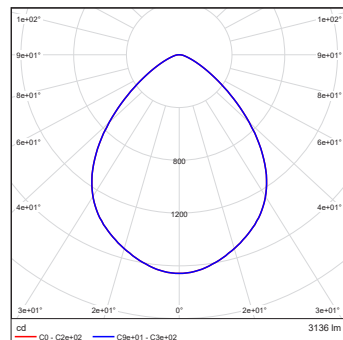

PHOTOMETRIC DATA

Eminere Inground 4 MC RGBCW
Anti-Skid Glass 20dg x 35dg

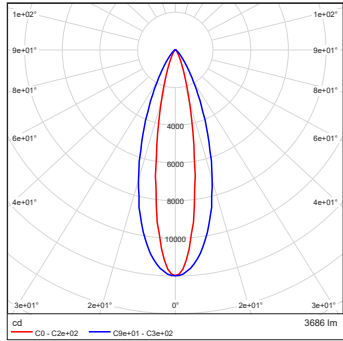

Eminere Inground 4 MC RGBCW
Anti-Skid Glass 20dg x 65dg

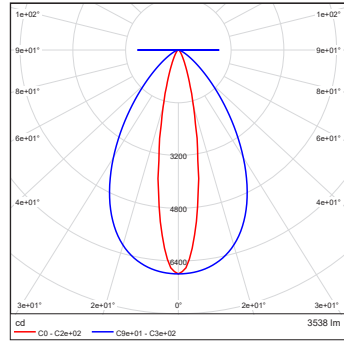

Eminere Inground 4 MC RGBCW
Anti-Skid Glass 40dg x 70dg

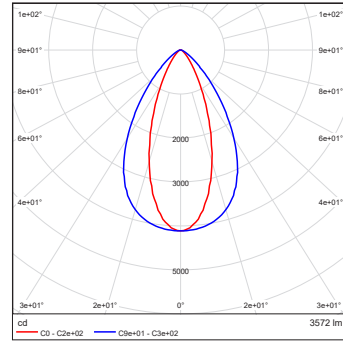

Eminere Inground 4 MC RGBCW
Anti-Skid Glass 20dg x 90dg

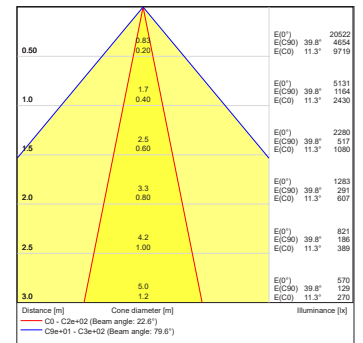
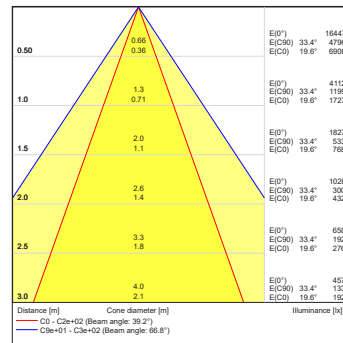
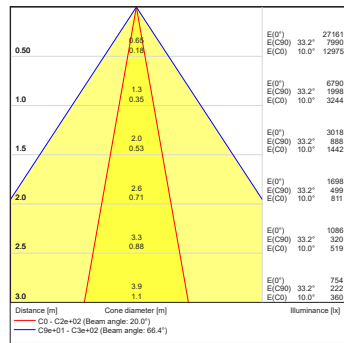
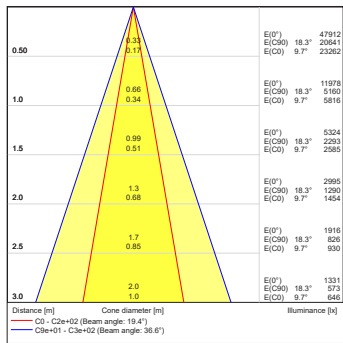
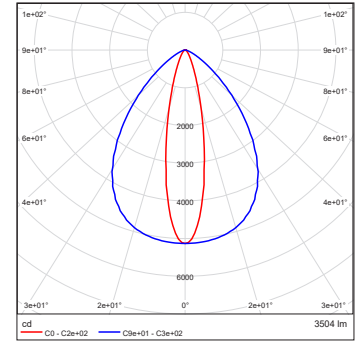

Eminere Inground 4 MC RGBCW
Anti-Skid Glass WallWasher

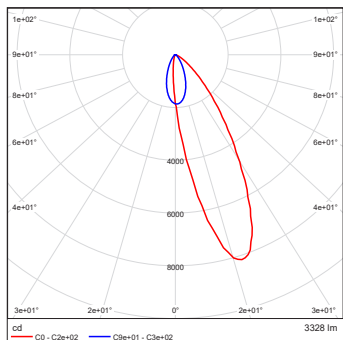

Eminere Inground 4 MC RGBCW
Anti-Skid Glass Wide WallWasher

