

Lamari™ SC 0.5/Lamari™ MC 0.5
Lamari™ SC 1/Lamari™ MC 1
Lamari™ SC 2/Lamari™ MC 2
Lamari™ SC 3/Lamari™ MC 3
Lamari™ SC 4/Lamari™ MC 4

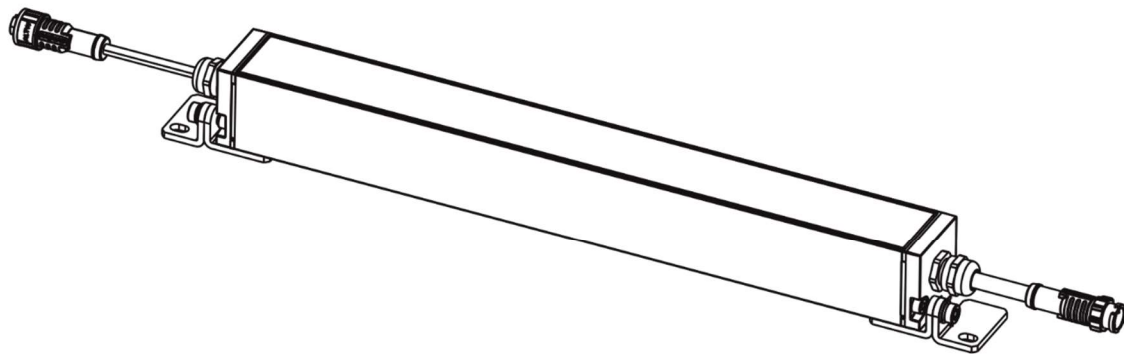

QR code for user manual

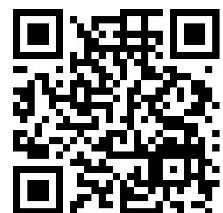

USER MANUAL

Version 1.3

Table of contents

1. Safety instructions	3
2. Fixture exterior view	5
3. Installation	6
3.1 Mounting the fixture	6
3.2 Connection to driver	7
3.3 Wiring of connection cables	15
3.4 Example of Control panel in RDM manager	17
4. Software update	19
5. Technical specifications	20
6. Cleaning and maintenance	26
6.1 Disposing of the product	26
7. ChangeLog	26

**FOR YOUR OWN SAFETY, PLEASE READ THIS USER MANUAL CAREFULLY
BEFORE POWERING OR INSTALLING YOUR Lamari !
Save it for future reference.**

This device has left our premises in absolutely perfect condition. In order to maintain this condition and to ensure safe operation, it is absolutely necessary for the user to follow the safety instructions and warnings written in this manual.

The manufacturer will not accept liability for any resulting damages caused by the non-observance of this manual or any unauthorized modification to the device.

Unauthorized modification will void warranty.

1. Safety instructions

DANGEROUS VOLTAGE CONSTITUTING A RISK OF ELECTRIC SHOCK IS PRESENT WITHIN THIS UNIT!

Always disconnect the fixture from power before cleaning, servicing or installing.

This fixture falls under protection class III.

LED light emission. Risk of eye injury. Do not look into the beam from a short distance without suitable protective eyewear. Do not look at LEDs with magnifiers or similar optical instruments that may concentrate the light output.

The fixture was designed for outdoor use. This fixture must not be used for underwater installation.

When choosing the installation spot, please make sure that the fixture is not exposed to extreme heat or dust. Do not install the unit near an open flame.

Avoid using the unit in locations subject to possible impacts.

The fixture body never must be covered with cloth or other materials when the fixture is under operation.

Only operate the fixture after having checked that the housing is firmly closed and all screws are tightly fastened.

The fixture becomes hot during operation. Allow the fixture to cool approximately 30 minutes prior to servicing or maintenance.

Operate the fixture only after having familiarized yourself with its functions. Do not permit operation by persons not qualified to operate the fixture.

Please consider that unauthorized modifications on the fixture are forbidden due to safety reasons!

Please use the original packaging if the fixture is to be transported.

If the device has been exposed to drastic temperature fluctuation (e.g. after transportation), do not switch it on immediately. The arising condensation water might damage your device. Leave the device switched off until it has reached room temperature.

If this device will be operated in any way different to the one described in this manual, the product may suffer damages and the warranty becomes void. Furthermore, any other operation may lead to dangers like short-circuit, burns, electric shock etc.

Refer servicing to qualified service personnel.

The product (covers and cables) must not be exposed to a high frequency electromagnetic field higher than 3V/m.

Immunity of the equipment is designed according to the standard EN 55035 Electromagnetic compatibility of multimedia equipment - Immunity requirements

Emission of the equipment complies with the standard EN55032 Electromagnetic compatibility of multimedia equipment – Emission Requirements according to class A.

This device complies with part 15 of the FCC Rules. Operation is subject to the following two conditions: (1) This device may not cause harmful interference, and (2) this device must accept any interference received, including interference that may cause undesired operation.

Changes or modifications not expressly approved by the party responsible for compliance could void the user's authority to operate the equipment.

The [Device] wireless operation is safe and complies to RF Exposure requirements.

This equipment has been tested and found to comply with the limits for a Class A digital device, pursuant to part 15 of the FCC Rules. These limits are designed to provide reasonable protection against harmful interference in a residential installation. This equipment generates, uses and can radiate radio frequency energy and, if not installed and used in accordance with the instructions, may cause harmful interference to radio communications. However, there is no guarantee that interference will not occur in a particular installation. If this equipment does cause harmful interference to radio or television reception, which can be determined by turning the equipment off and on, the user is encouraged to try to correct the interference by one or more of the following measures:

- Reorient or relocate the receiving antenna.
- Increase the separation between the equipment and receiver.
- Connect the equipment into an outlet on a circuit different from that to which the receiver is connected.
- Consult the dealer or an experienced radio/TV technician for help.

Warning for fixtures with Harsh Environment Finish (HEF):

Handle with care!

Avoid any damage to the painted surface.

Damaging the paint may result in corrosion and loss of warranty.

2. Fixture exterior view

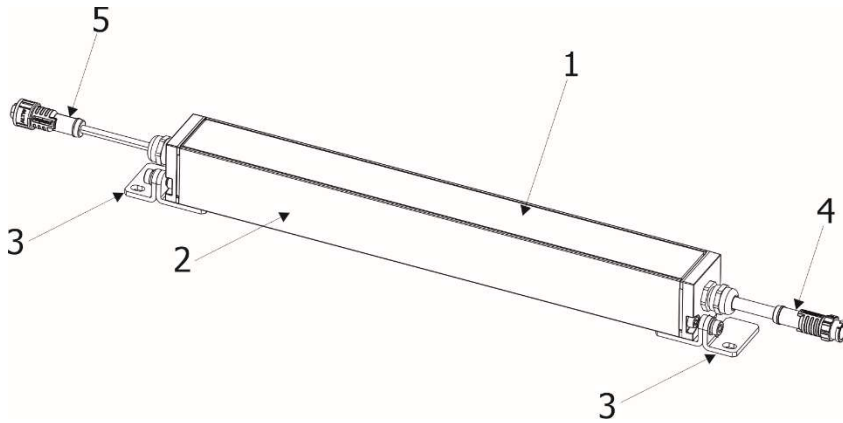

- 1. Transparent glass cover
- 2. Housing
- 3. Mounting brackets
- 4. Input
- 5. Output

Cable entry options

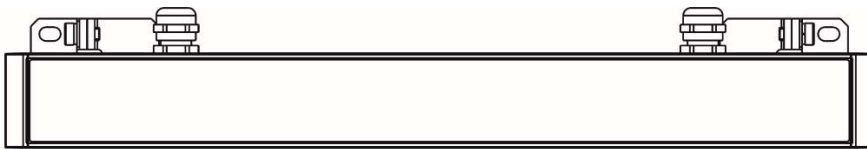

Rear IN/OUT version

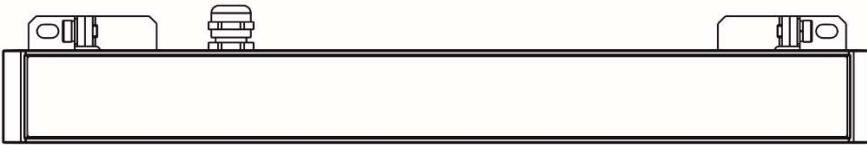

Rear IN version



Side IN/OUT version



Side IN version

3. Installation

3.1 Mounting the fixture.

The Lamari can be arranged in any orientation on a flat, non-flammable surface by means of two mounting brackets (3) with holes of diameter of 5 mm. Both mounting brackets can be tilted by 10° (towards the wall).

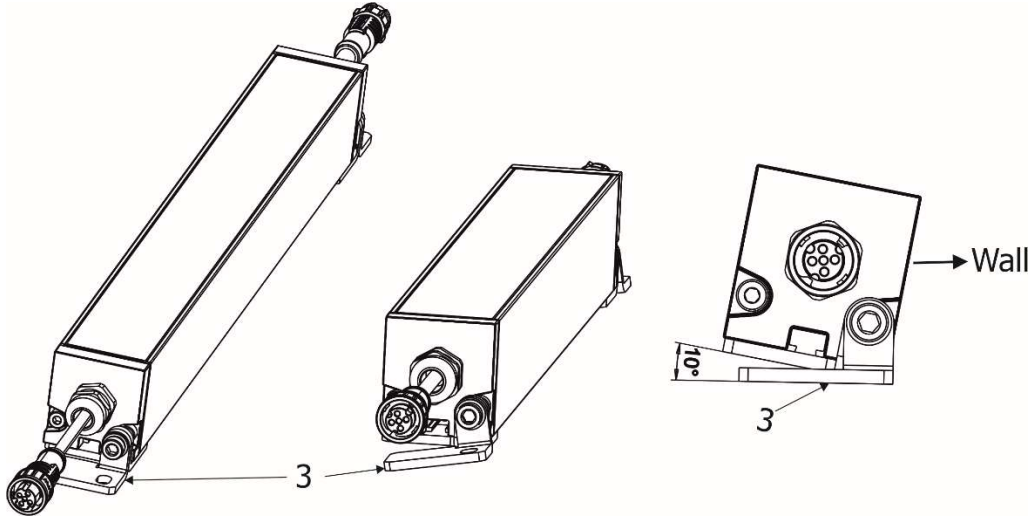

Note for rear version of the Lamari.

Min distance between the Lamari and the wall has to be at least 65mm due to cable bend.

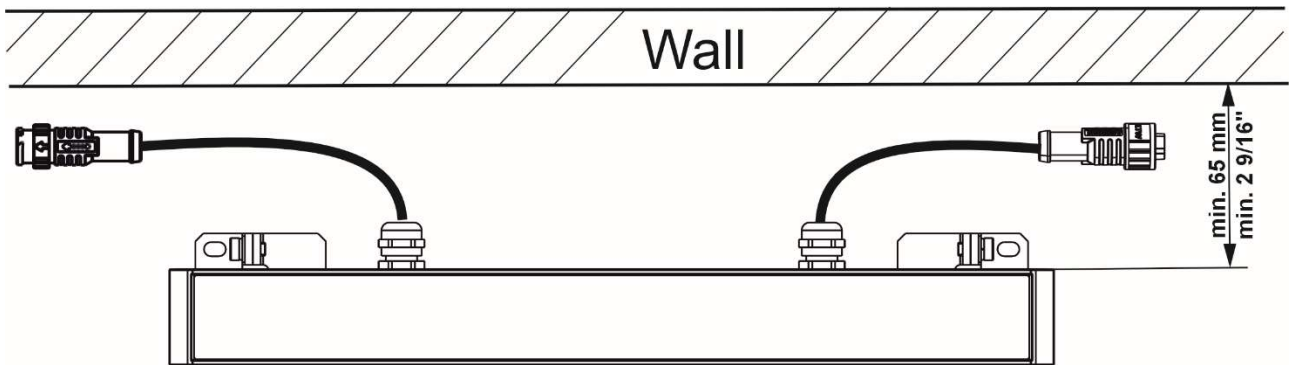

3.2 Connection to driver

The unit must be installed by a qualified electrician in accordance with all national and local electrical and construction codes and regulations.

The Lamari modules should be connected to the E-Box Remote/E-Box Remote basic.

The Lamaris have to be operated in the Pass-Through mode only. The option **Pass-Thr** has to be selected from the menu **E-box mode** of the E-box Remote menu.

⚠ When connecting Lamari to the E-box (E-box Remote/E-box Remote Basic), make sure that the E-box is disconnected from power!

⚠ All unused Lamari cable connectors have to be covered with caps (caps are part of the Lamari), also unused Lamari output T connectors have to be covered by caps.

Example of connection - E-box Remote with cable glands

CE

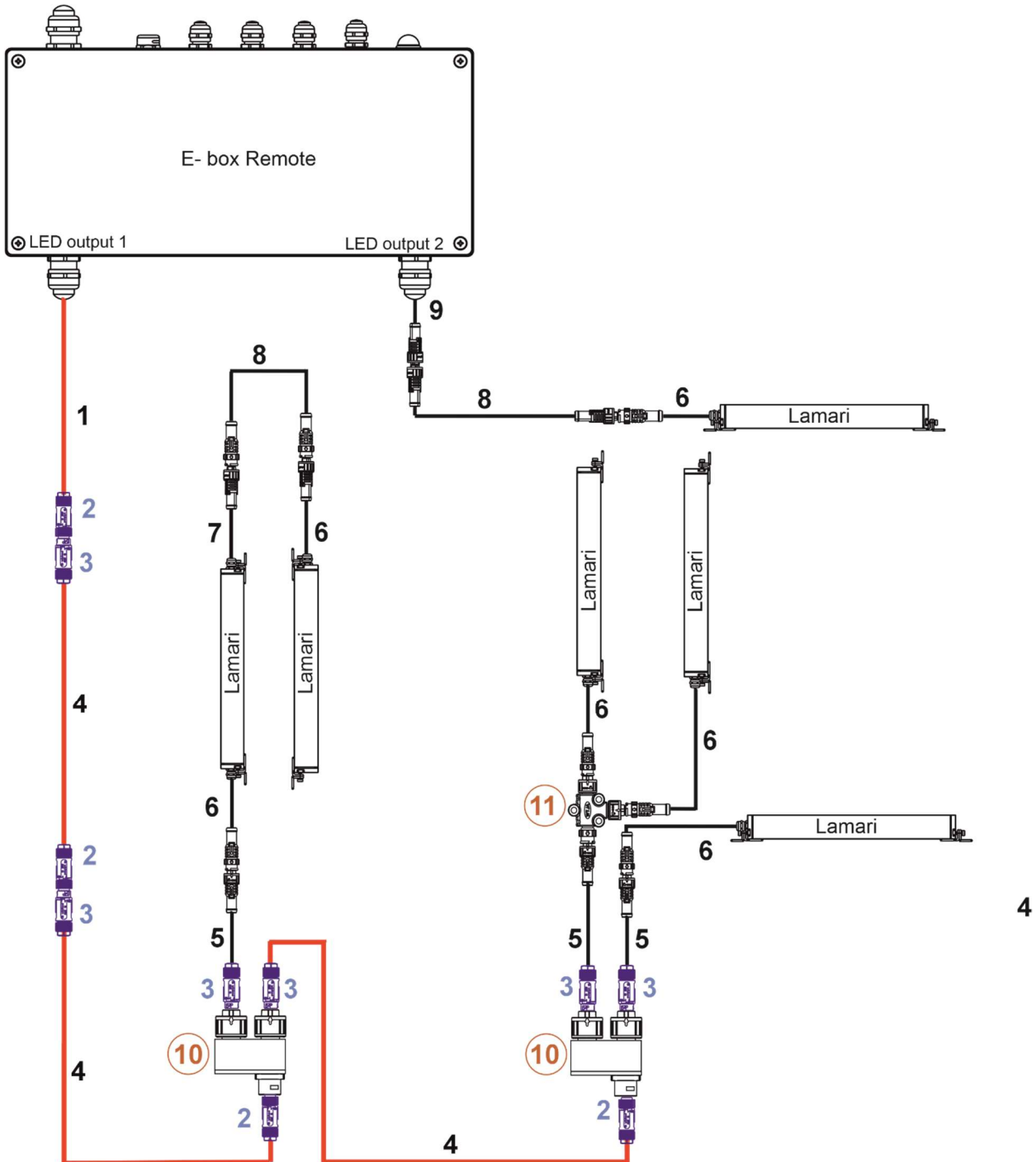

- 1- Cable SJTW 5x AWG 14 (P/N 13053336), Standard with bare-end, black or cable SJTW 5x AWG 14 (P/N 13053697), with bare-end, white (on request).
Leader cables:
 - Leader Cable CE/US FF conMID-05 L=1m (14 AWG), P/N 13054151
 - Leader Cable CE/US FF conMID-05 L=3m (14 AWG), P/N 13054152
 - Leader Cable CE/US FF conMID-05 L=5m (14 AWG), P/N 13054153
 - Leader Cable CE/US FF conMID-05 L=10m (14 AWG), P/N 13054154
- 2- Connector Wieland MID-05FF (P/N 13154127)
- 3- Connector Wieland MID-05MM (P/N 13154126)
- 4- Cable SJTW 5x AWG 14 (P/N 13053336), Standard with bare-end, black or cable SJTW 5x AWG 14 (P/N 13053697), with bare-end, white (on request).
Jumper cables:
 - Jumper cable CE/US MID-05FF/MM L=0.5m (14 AWG), P/N 13054131
 - Jumper cable CE/US MID-05FF/MM L=1m (14 AWG), P/N 13054132
 - Jumper cable CE/US MID-05FF/MM L=3m (14 AWG), P/N 13054133
 - Jumper cable CE/US MID-05FF/MM L=5m (14 AWG), P/N 13054134
 - Jumper cable CE/US MID-05FF/MM L=5m (14 AWG), P/N 13054147
- 5- Cable reduction MID2MINI (P/N 13054149)
- 6- Cable (5x AWG20) 0.5m, with Connector MM (P/N 13053935)
- 7- Cable (5x AWG20) 0.1m, with Connector FF (P/N 13053936)
- 8- Jumper cable (5x AWG20) with Connectors FF-MM
Jumper cables:
 - Jumper cable, L=0.5M AD-05BMMM + AD-05BFFM (P/N 13053937-02)
 - Jumper cable, L=1M AD-05BMMM + AD-05BFFM (P/N 13053938-02)
 - Jumper cable, L=3M AD-05BMMM + AD-05BFFM (P/N 13053939-02)
 - Jumper cable, L=5M AD-05BMMM + AD-05BFFM (P/N 13053940-02)
 - Jumper cable, L=10M AD-05BMMM + AD-05BFFM (P/N 13054148)
- 9- Cable (5x AWG20) 0.1m, with Connector FF (P/N 13053936)
- 10- Connector T MID-05 MFFT Wieland (1 x male, 2 x female) (P/N 13054130)
- 11- Connector T MINI -05 MFF (P/N 13053941-01)

Example of connection - E-box Remote with panel connectors

CE

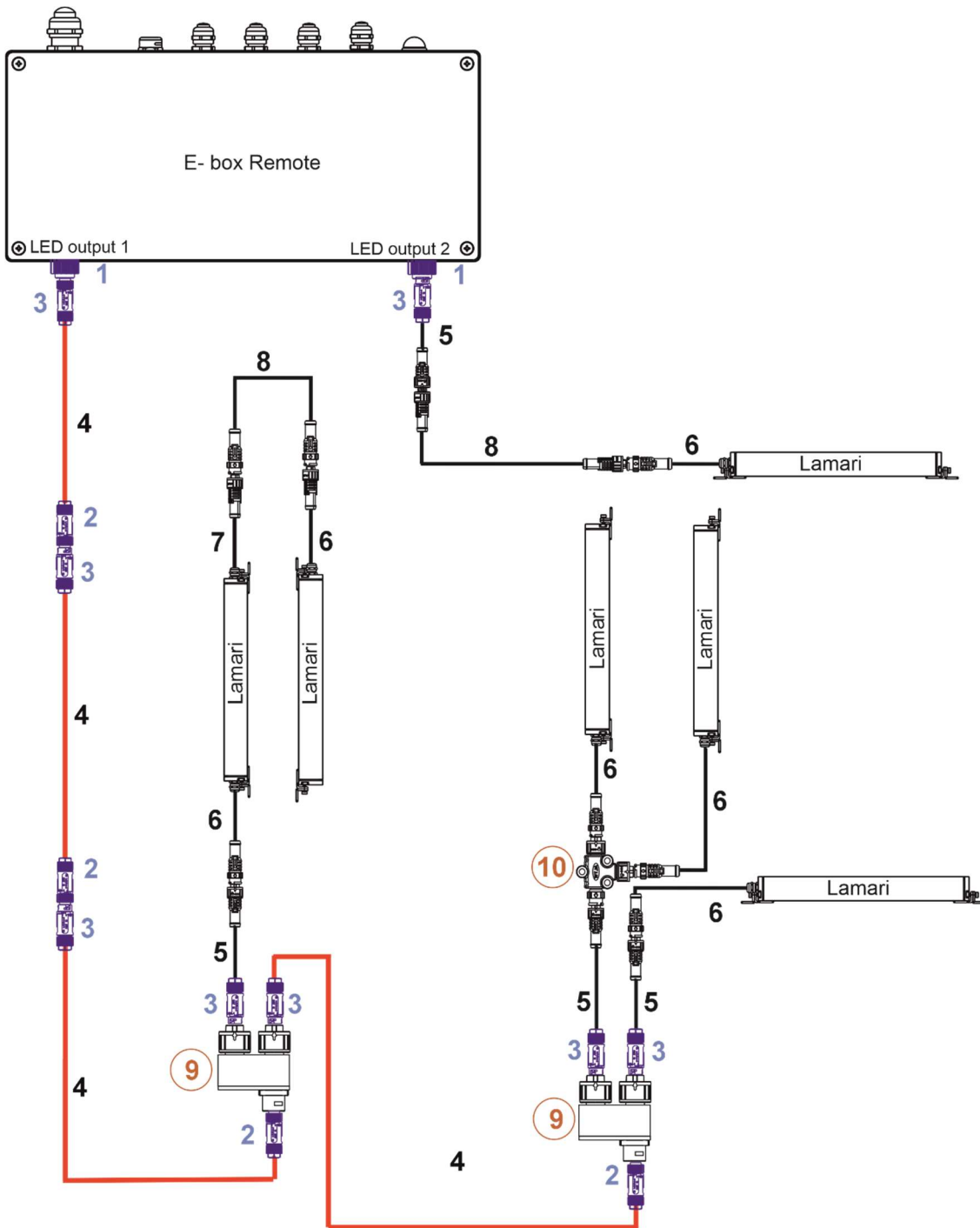

- 1- Panel connector MID-05 FF (14-22AWG), P/N 13054129
- 2- Connector Wieland MID-05FF (P/N 13154127)
- 3- Connector Wieland MID-05MM (P/N 13154126)
- 4- Cable SJTW 5x AWG14 (P/N 13053336), Standard with bare-end, black or cable SJTW 5x AWG14 (P/N 13053697), with bare-end, white (on request).

Jumper cables:

- Jumper cable CE/US MID-05FF/MM L=0.5m (14 AWG), P/N 13054131
- Jumper cable CE/US MID-05FF/MM L=1m (14 AWG), P/N 13054132
- Jumper cable CE/US MID-05FF/MM L=3m (14 AWG), P/N 13054133
- Jumper cable CE/US MID-05FF/MM L=5m (14 AWG), P/N 13054134
- Jumper cable CE/US MID-05FF/MM L=5m (14 AWG), P/N 13054147

- 5- Cable reduction MID2MINI (P/N 13054149)
- 6- Cable (5x AWG20) 0.5m, with Connector MM (P/N 13053935)
- 7- Cable (5x AWG20) 0.1m, with Connector FF (P/N 13053936)
- 8- Jumper cable (5x AWG20) with Connectors FF-MM
Jumper cables:
 - Jumper cable, L=0.5M AD-05BMMM + AD-05BFFM (P/N 13053937-02)
 - Jumper cable, L=1M AD-05BMMM + AD-05BFFM (P/N 13053938-02)
 - Jumper cable, L=3M AD-05BMMM + AD-05BFFM (P/N 13053939-02)
 - Jumper cable, L=5M AD-05BMMM + AD-05BFFM (P/N 13053940-02)
 - Jumper cable, L=10M AD-05BMMM + AD-05BFFM (P/N 13054148)
- 9- Connector T MID-05 MFFT Wieland (1 x male, 2 x female) (P/N 13054130)
- 10- Connector T MINI -05 MFF (P/N 13053941-01)

**Example of connection - E-box Remote with cable glands
US**

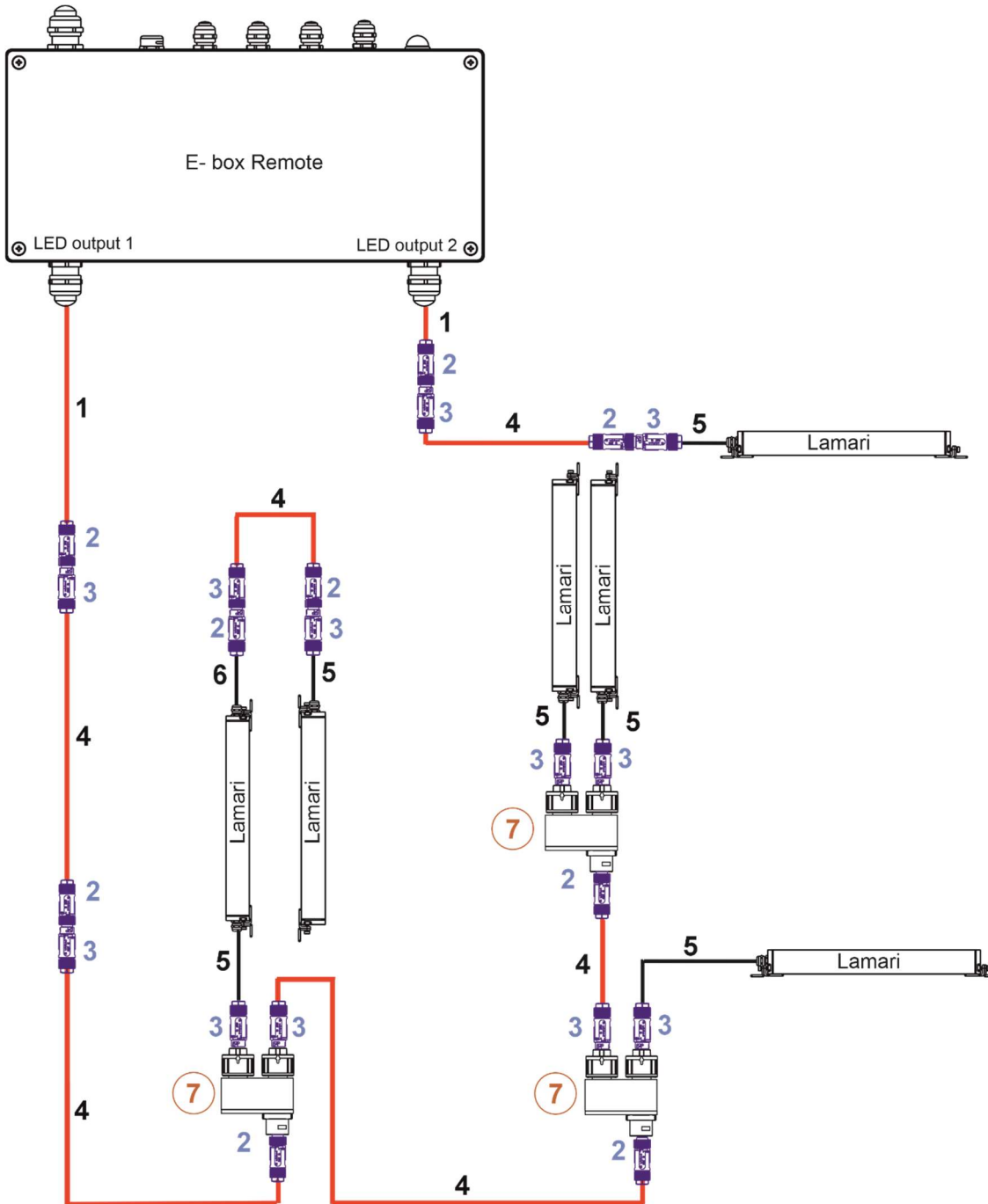

- 1- Cable SJTW 5x AWG14 (P/N 13053336), Standard with bare-end, black or cable SJTW 5x AWG14 (P/N 13053697), with bare-end, white (on request).

Leader cables:

- Leader Cable CE/US FF conMID-05 L=1m (14 AWG), P/N 13054151
- Leader Cable CE/US FF conMID-05 L=3m (14 AWG), P/N 13054152
- Leader Cable CE/US FF conMID-05 L=5m (14 AWG), P/N 13054153
- Leader Cable CE/US FF conMID-05 L=10m (14 AWG), P/N 13054154

- 2- Connector Wieland MID-05FF (P/N 13154127)
- 3- Connector Wieland MID-05MM (P/N 13154126)

Lamari

- 4- Cable SJTW 5x AWG14 (P/N 13053336), Standard with bare-end, black or cable SJTW 5x AWG14 (P/N 13053697), with bare-end, white (on request).
Jumper cables:
 - Jumper cable CE/US MID-05FF/MM L=0.5m (14 AWG), P/N 13054131
 - Jumper cable CE/US MID-05FF/MM L=1m (14 AWG), P/N 13054132
 - Jumper cable CE/US MID-05FF/MM L=3m (14 AWG), P/N 13054133
 - Jumper cable CE/US MID-05FF/MM L=5m (14 AWG), P/N 13054134
 - Jumper cable CE/US MID-05FF/MM L=5m (14 AWG), P/N 13054147
- 5- Cable-UL-20969 black 5x AWG18 (P/N 13054125), 0.5m, with connector Connector Wieland MID-05MM (P/N 13154126)
- 6- Cable-UL-20969 black 5x AWG18 (P/N 13054125), 0.1m, with connector Connector Wieland MID-05FF (P/N 13154127)
- 7- Connector T MID-05 MFFT Wieland (1 x male, 2 x female) (P/N 13054130)

Example of connection - E-box Remote with panel connectors

US

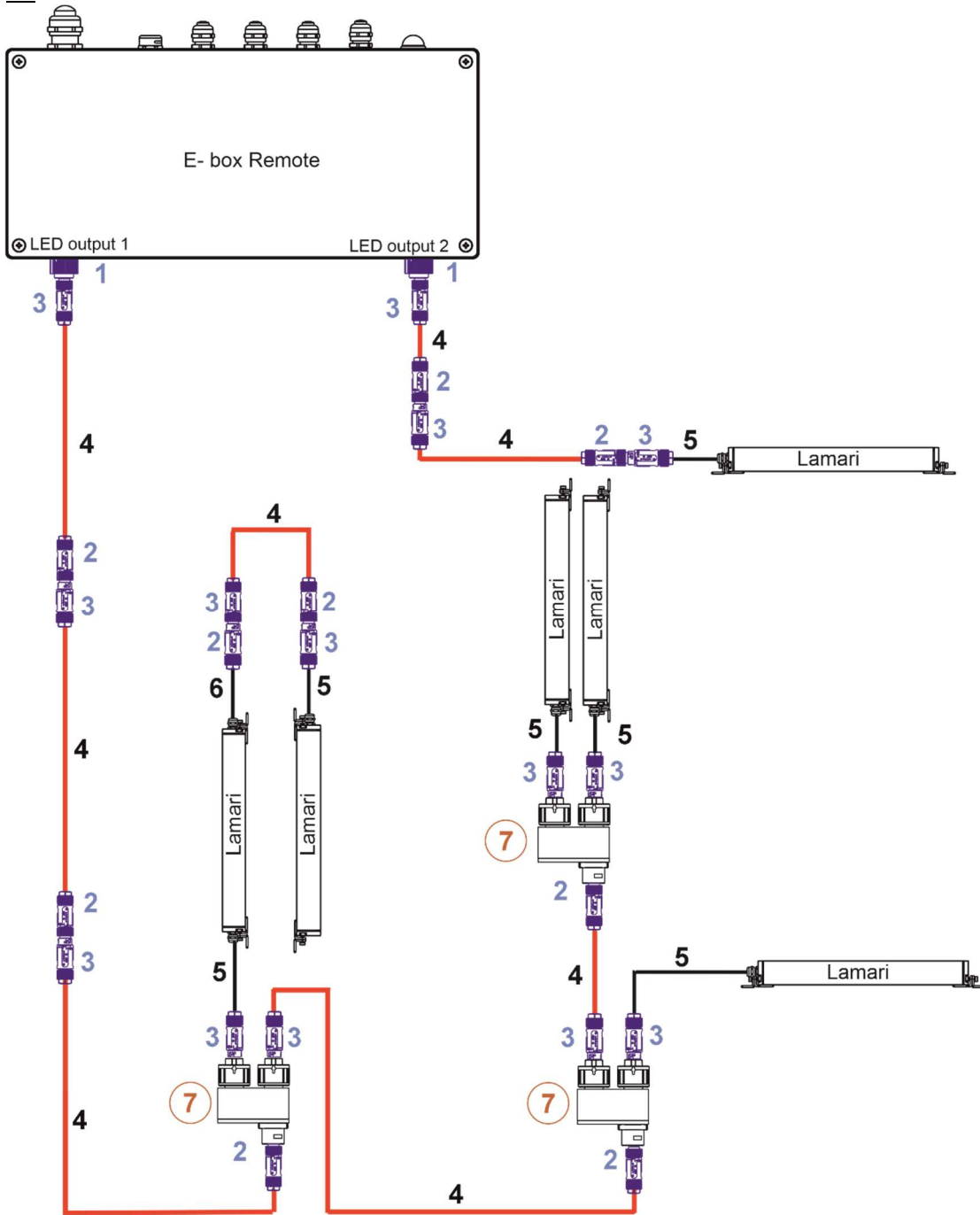

- 1- Panel connector MID-05 FF (14-22AWG), P/N 13054129
- 2- Connector Wieland MID-05FF (P/N 13154127)
- 3- Connector Wieland MID-05MM (P/N 13154126)
- 4- Cable SJTW 5x AWG14 (P/N 13053336), Standard with bare-end, black or cable SJTW 5x AWG14 (P/N 13053697), with bare-end, white (on request).

Jumper cables:

- Jumper cable CE/US MID-05FF/MM L=0.5m (14 AWG), P/N 13054131
- Jumper cable CE/US MID-05FF/MM L=1m (14 AWG), P/N 13054132
- Jumper cable CE/US MID-05FF/MM L=3m (14 AWG), P/N 13054133
- Jumper cable CE/US MID-05FF/MM L=5m (14 AWG), P/N 13054134
- Jumper cable CE/US MID-05FF/MM L=5m (14 AWG), P/N 13054147

Lamari

- 5- Cable-UL-20969 black 5x AWG 18 (P/N 13054125), 0.5m, with connector Connector Wieland MID-05MM (P/N 13154126)
- 6- Cable-UL-20969 black 5x AWG 18 (P/N 13054125), 0.1m, with connector Connector Wieland MID-05FF (P/N 13154127)
- 7- Connector T MID-05 MFFT Wieland (1 x male, 2 x female) (P/N 13054130)



Each line of Lamaris connected to the LED output of the E-box Remote/E-box Remote Basic has to be terminated at the last fixture via RDM Control panel as described in the chapter 3.4 Example of Control panel in RDM manager.

3.3 Wiring of connection cables

1. Jumper cable CE/US MID-05FF/MM (all length)

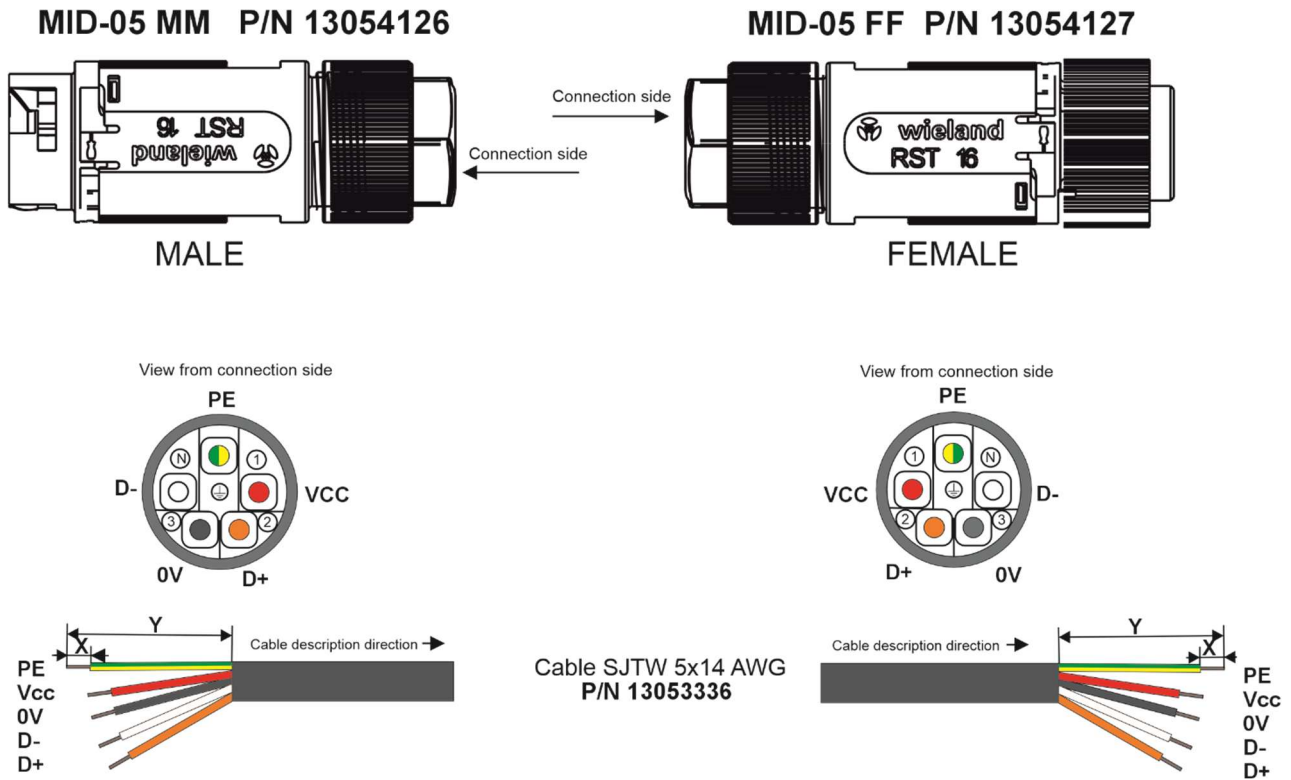

	PE	Vcc, 0V, D-, D+
Cable stripping length Y (mm)	30	25
Wire stripping length X (mm)	8	

IMPORTANT

Do not bend the cable near to the connector, minimum distance for bending is 50mm.



2. Lamari IN/OUT cables (US)

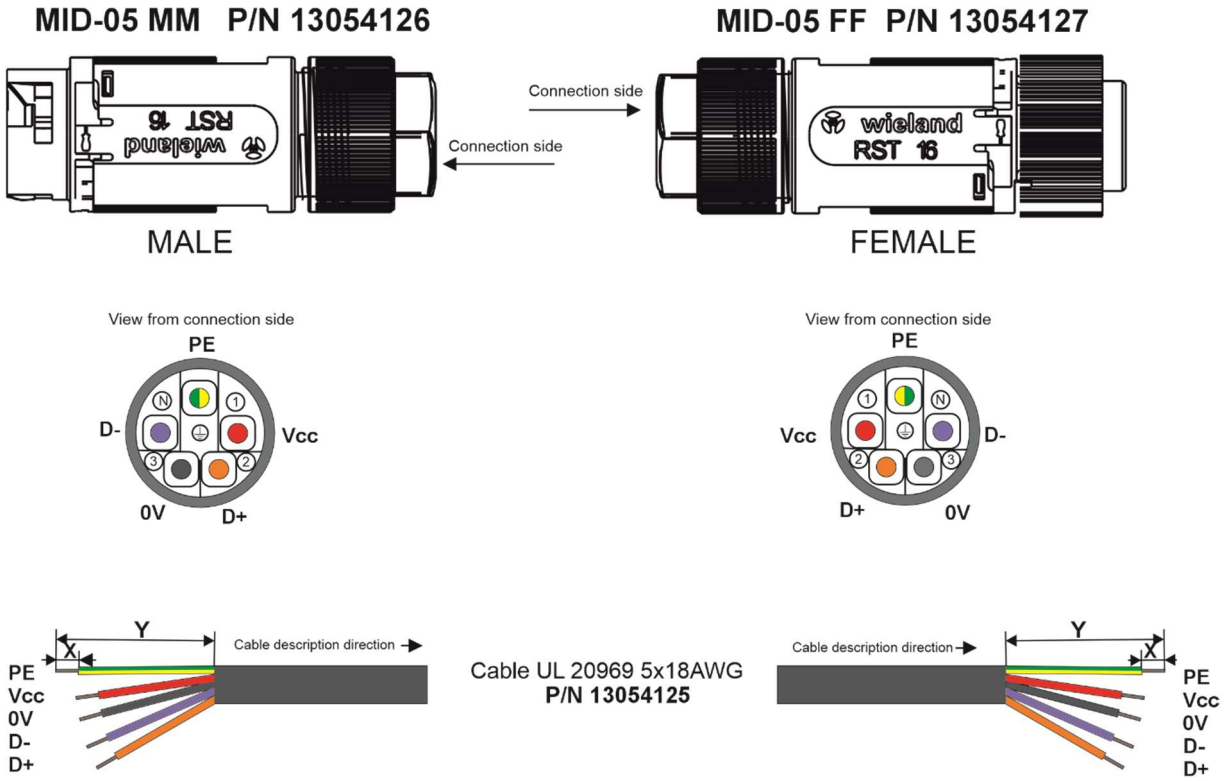

IMPORTANT!

For cable UL 20969 5xAWG18, remove original gasket from the Vieland connector and use gasket P/N 13051388.

	PE	Vcc, 0V, D-, D+
Cable stripping length Y (mm)	30	25
Wire stripping length X (mm)	8, install cord end-sleeves (diameter of 0.75 mm) P/N 13050155 on each wire	

3. Lamari IN/OUT cables (EU)

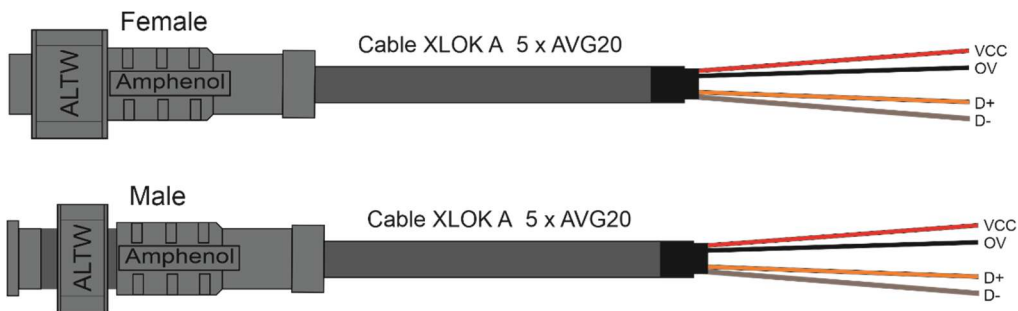

	Vcc	D+	D-	0V
Function	LEDs +	Data +	Data -	LEDs -
Colour of wire*	Red	Orange	Brown	Black

The Amphenol connector is pressed on the cable.

*for cable XLOK A 5x AVG20

3.4 Example of Control panel in RDM manager

The software RDM manager is available on the ROBE website (<https://www.robe.cz/support>), product RUNIT WTX.

Control panel

Device: 52:53-01:2e:00:7f

Product information

RDM protocol version: 0x0100

Device model ID: 0x0154

Product category: 0x0102

Software version: 12

Subdevice count: 0

Sensor count: 1

Manufacturer label: ROBE lighting s.r.o.

Device model description: Lamari

Device label: LamariMC

DMX512 setup

DMX512 footprint: 4

Current personality: DMX Preset 01- 4

Personalities count: 23

DMX address: 1

Power/Lamp setup

Device hours: 0

Configuration

Factory defaults: Set

Control

Identify device: off

Display settings

Manufacturer PIDs

LED calibration 4byte HEX! (RGBW/RGBA): ff ff ff ff (hex)

Insect friendly light (0 = off, 1 = on): 00 (hex)

Pixel swap (0-dis 1-act): 00 (hex)

Terminator active (0-dis 1-en): 00 (hex)

Green arrow saves changes made in the Control panel to the Lamari.

Manufacturer PIDs

LED calibration 4byte HEX! (RGBW/RGBA) - the item shows 4 bytes of calibration values for calibrated white colours of RGBW(RGBA) Lamari.

E.g.

LED calibration 4byte HEX! (RGBW/RGBA): ff 88 00 08 (hex)

CTC channel has to be set to some calibrated white colour (21 DMX-1800K, 66 DMX-2700K, 91 DMX-3200K, 141 DMX-4200K, 211 DMX-5600K, 255 DMX-6500K) otherwise the item shows values "ff ff ff ff" (and calibration values cannot be saved to the Lamari).

Warning!

Changing and saving values in this item will affect calibrated white colour(s) of the Lamari.

Lamari

Insect friendly light - the item effects RGBA Eminere Remote only. If the item is on, blue colour is not used in calibrated white colours. This modification of white lights results in a smaller attraction of white light for insects (mosquitos, moths..). The function is also available from DMX chart (channel Special Function, range 7-10 DMX).

Insect friendly light (0 = off, 1 = on): (hex)

Pixel Swap – the item allows you to swap the pixel order.

Pixel swap (0-dis 1-act): (hex)

Terminator active - the item allows you to terminate line of Lamaris at last Lamari.

Last Lamari in each data line has to be terminated by setting the 'Manufacturer PID' 'Terminator active' to '1'.

Terminator active (0-dis 1-en): (hex)

4. Software update

Software update of Lamari has to be done by means of the software ROBE Uploader running on PC.

The ROBE Uploader is a software for automatized software update of ROBE fixtures. The ROBE Uploader switches Lamari to the update mode automatically.

Please see <https://www.robe.cz/robe-uploader/> for more information about ROBE uploader and the E-box Remote user manual (E-box Remote Basic user manual).

5. Technical specifications

Power supply

- Input voltage: 48 V
- Power consumption:
 - Lamari SC 0.5: 5W
 - Lamari SC 1: 10W
 - Lamari SC 2: 20W
 - Lamari SC 3: 30W
 - Lamari SC 4: 40W

 - Lamari MC 0.5: 5W
 - Lamari MC 1: 10W
 - Lamari MC 2: 20W
 - Lamari MC 3: 30W
 - Lamari MC 4: 40W

Optic

- Light source:
 - Lamari SC 0.5: 4 x high power single chip LEDs
 - Lamari SC 1: 8 x high power single chip LEDs
 - Lamari SC 2: 16 x high power single chip LEDs
 - Lamari SC 3: 24 x high power single chip LEDs
 - Lamari SC 4: 32 x high power single chip LEDs

 - Lamari MC 0.5: 5 x high power multichip LEDs
 - Lamari MC 1: 12 x high power multichip LEDs
 - Lamari MC 2: 24 x high power multichip LEDs
 - Lamari MC 3: 36 x high power multichip LEDs
 - Lamari MC 4: 48 x high power multichip LEDs
- Colour variants Lamari SC: PW 3000K, TW 2200–3000 K
- Colour variants Lamari MC: RGBW (W - 6500 K), RGBA,
- Beam angles Lamari SC (Without Linear Louvre)
 - Symmetrical: 12°, 15°, 25°, 35°, 50°, 70°, 105°
 - Bi-symmetrical: 10° x 20°, 10°x40°, 10° x 80°, 15° x 45°, 15° x 90°, 35° x 110°, 45°x 65°
- Beam angles Lamari SC (With Linear Louvre)
 - Symmetrical: 12°, 15°, 25°
 - Bi-symmetrical: 10°x20°, 10°x40°, 10°x80°, 15°x45°, 15°x90°, 35°x110°
- Beam angles Lamari MC
 - Symmetrical: 15°, 25°, 35°, 50°, 65°, 100°
 - Bi-symmetrical: 15°x40°, 15°x70°, 20°x45°, 20°x80°, 35°x110°, 40°x65°
- Beam angles Lamari MC (With Linear Louvre)
 - Symmetrical: 15°, 25°
 - Bi-symmetrical: 15°x40°, 15°x70°, 20°x45°, 20°x80°, 35°x110°
- Projected Lumen Maintenance: L90B10 >90.000 hrs, Ta = 25°C / 77°F

Compatible drivers

- E-box Remote, E-box Remote Basic

Mounting method

- Via two L-shape brackets with adjustment range 10°

Housing

- Aluminium extruded body
- Tempered glass

Cooling system

- Convection

Total heat dissipation

- Lamari SC 0.5/Lamari MC 0.5: 13 BTU/h (calculated)
- Lamari SC 1/Lamari MC 1: 25 BTU/h (calculated)
- Lamari SC 2/Lamari MC 2: 51 BTU/h (calculated)
- Lamari SC 3/Lamari MC 3: 76 BTU/h (calculated)
- Lamari SC 4/Lamari MC 4: 102 BTU/h (calculated)

Weight

- Lamari 0.5: 0.5 kg (1.1 lbs)
- Lamari 1: 0.9 kg (2.0 lbs)
- Lamari 2: 1.4 kg (3.1 lbs)
- Lamari 3: 2.2 kg (4.9 lbs)
- Lamari 4: 2.5 kg (5.5 lbs)

Dimensions (All dimensions in mm [inch])

Lamari SC 0.5/1/2/3/4 Rear IN

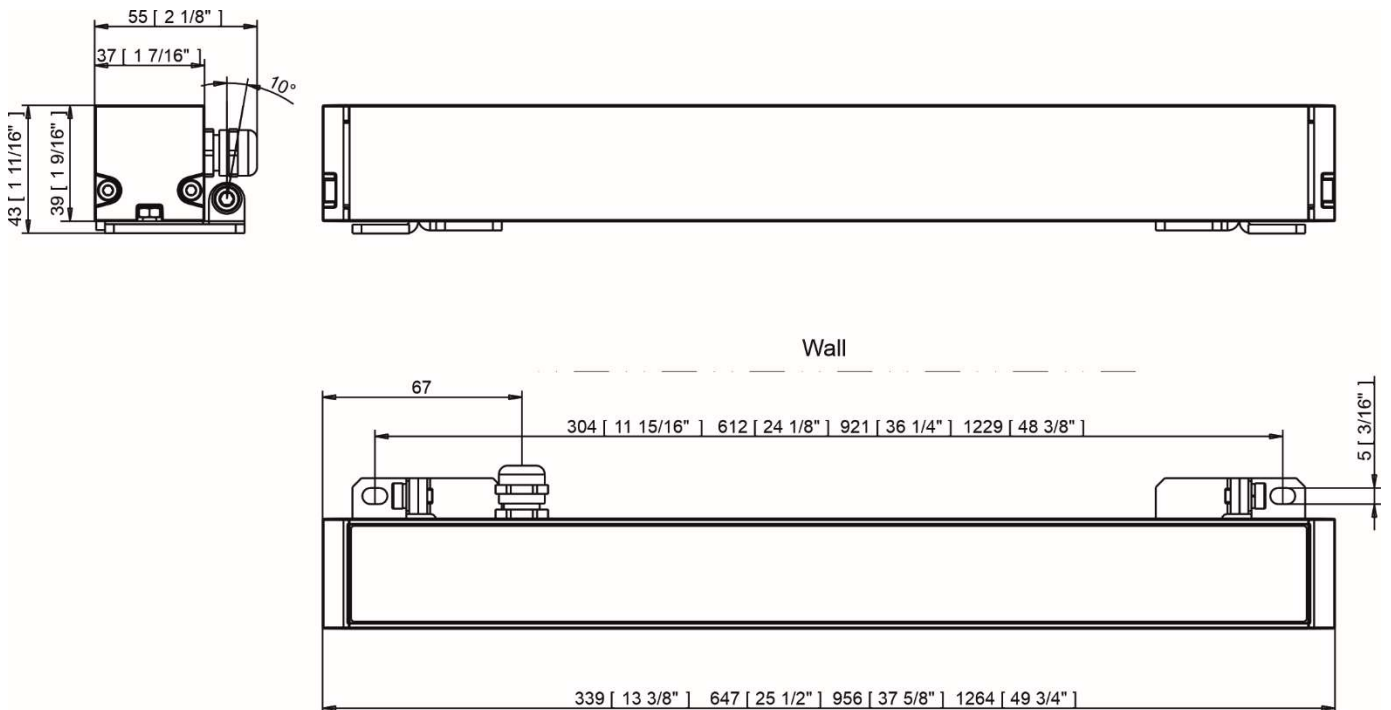

Lamari

Lamari SC 0.5/ 1/2/3/4 Rear IN/OUT

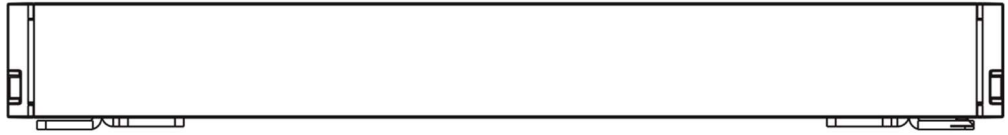
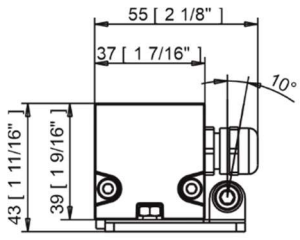

Wall

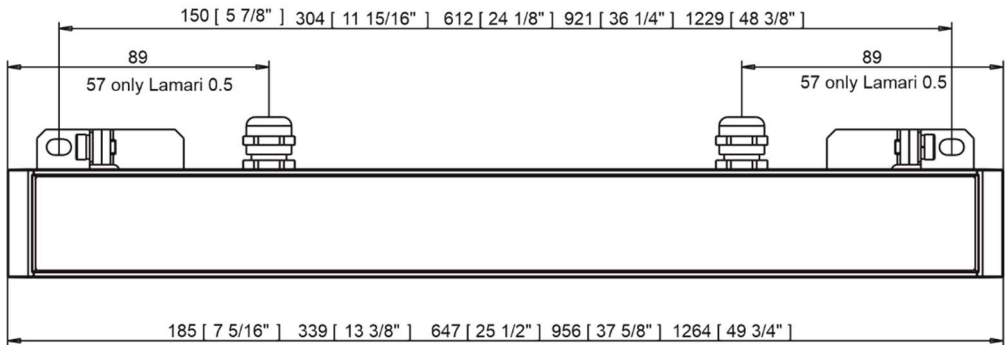

Lamari MC 1/2/3/4 Rear IN

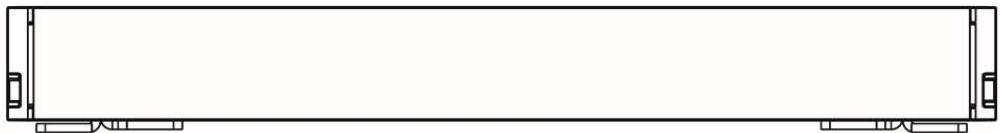
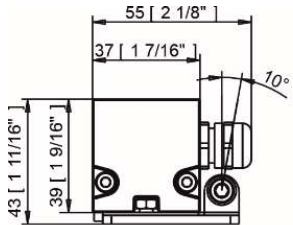

Wall

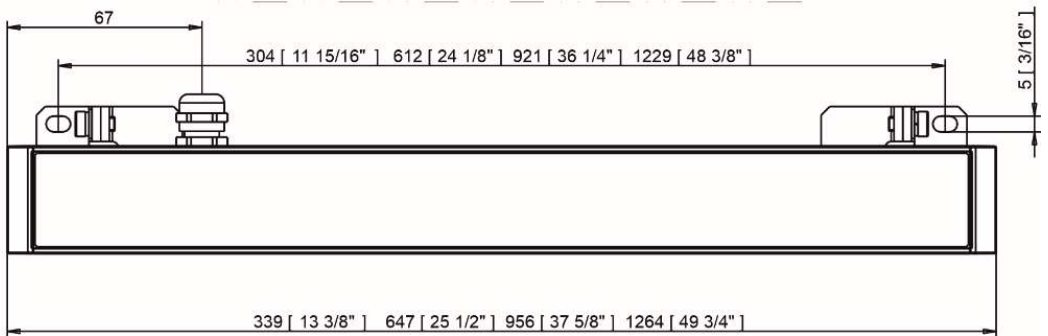

Lamari

Lamari MC 1/2/3/4 Rear IN/OUT

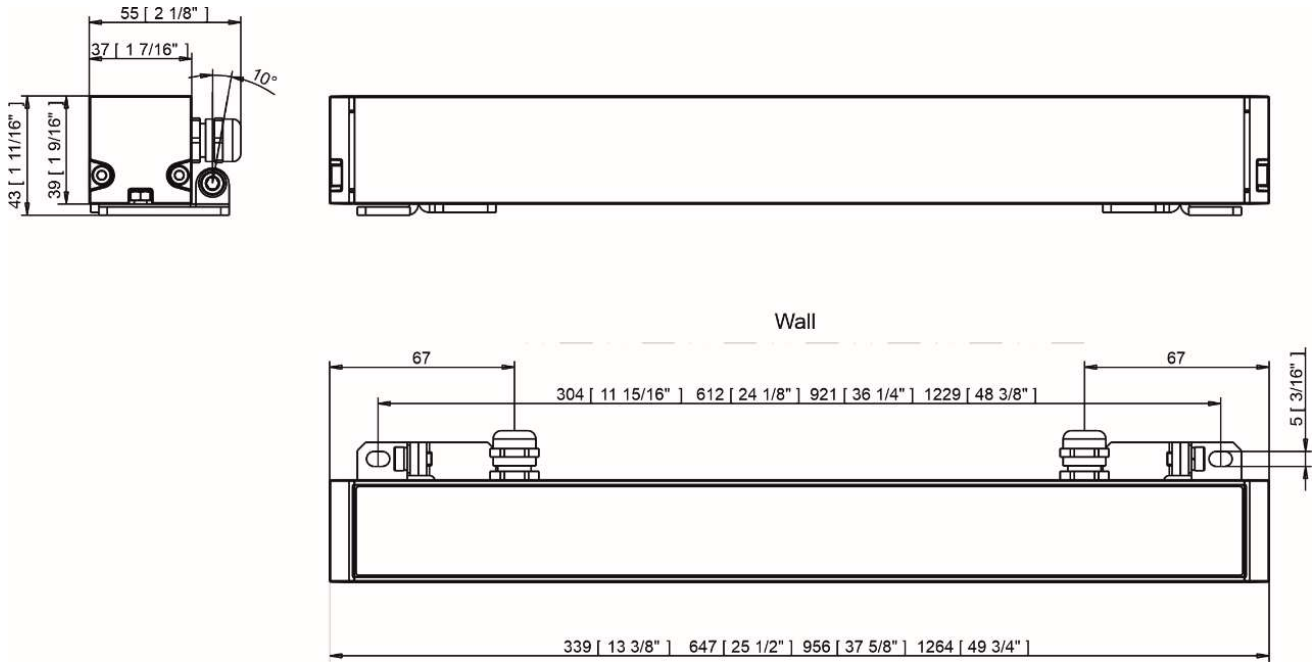

Lamari SC 0.5/ 1/2/3/4 Side IN Lamari MC 1/2/3/4 Side IN

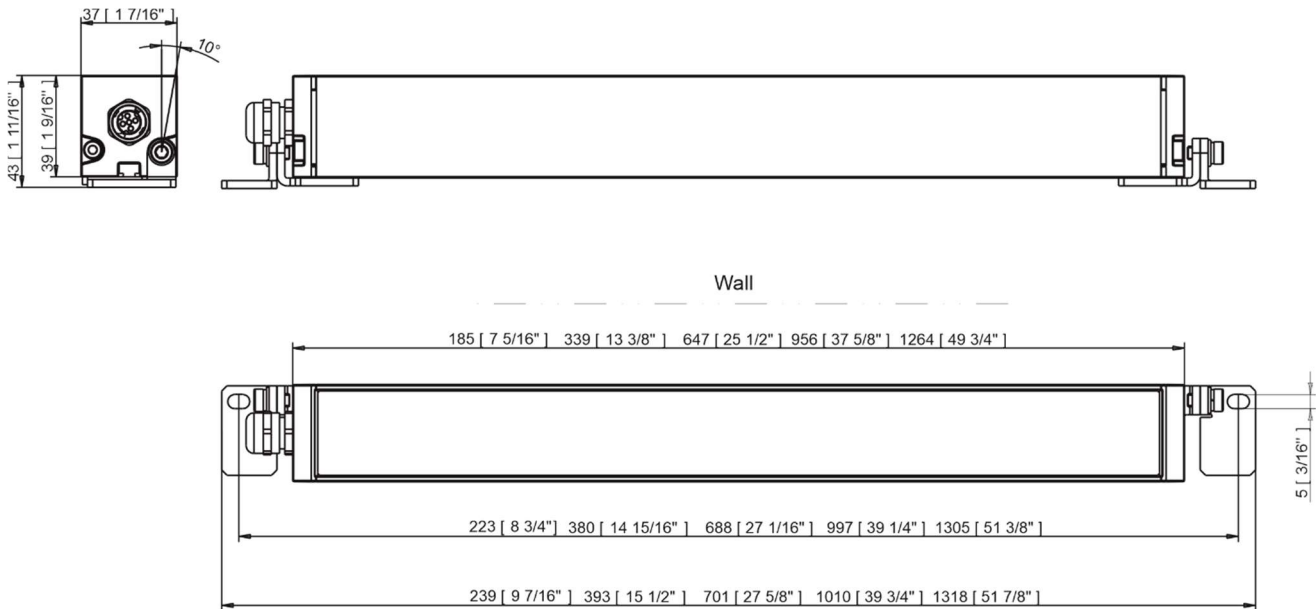

Lamari

Lamari SC 0.5/1/2/3/4 Side IN/OUT

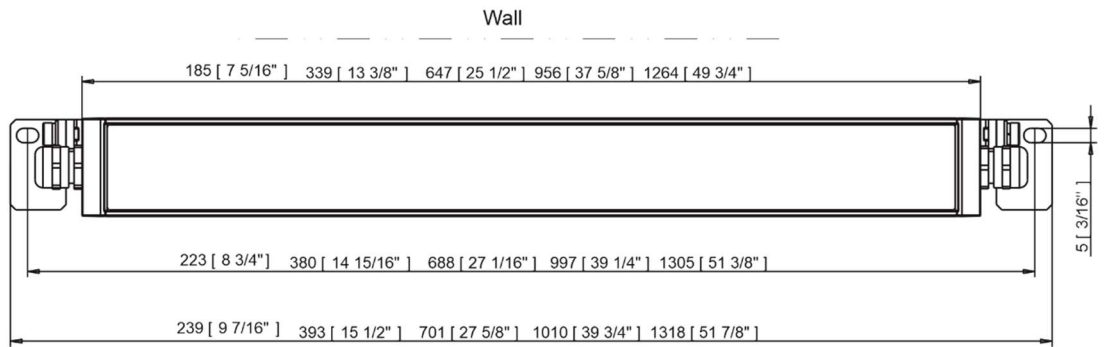
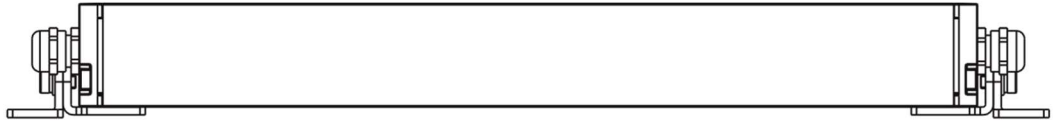
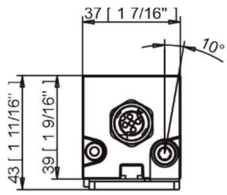

Lamari MC 1/2/3/4 Side IN/OUT

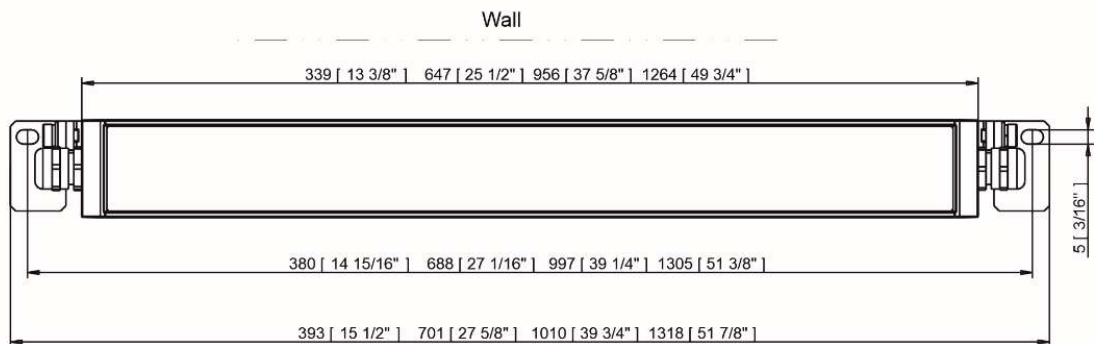
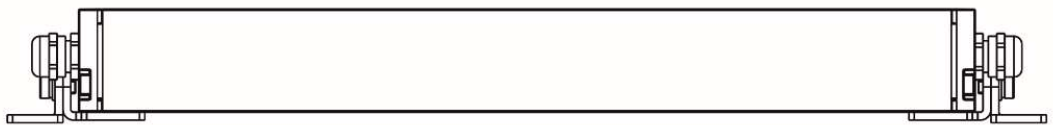
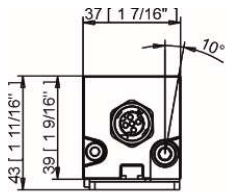

Protection factor

- CE: IP 67
- US: Suitable for wet location

Impact rating

- CE: IK 08

Operating ambient temperature range

- -20°C /+40°C (-4°F /+104°F)

Operating temperature

- +67°C @ Ambient +40°C (+153°F @ Ambient +104°F)

Connection

- CE version
Input: cable 5x AWG 20) 0.5m, with Connector MM (P/N 13053935)
Output: cable (5x AWG 20) 0.1m, with Connector FF (P/N 13053936)
- US version
Input: cable (5x AWG 18) 0.5m, with Connector MM (P/N 13154126)
Output: cable (5x AWG 18) 0.1m, with Connector FF (P/N13154127)

Included items

- 1 x Lamari
- 1 x Waterproof cap for M connector
- 1 x Waterproof cap for F connector
- 1 x User manual

Optional accessories

- Mounting Brackets 100mm
- Mounting Brackets 200mm
- Mounting Brackets 300mm
- Wall Mount Scissors Brackets
- Shield for Lamari 2 RAL 1014 (P/N 10981350):
- Barndoor 1 L32 RAL 1014 (P/N 10981356)
- Jumper cable, L=0.5M AD-05BMMM + AD-05BFFM (P/N 13053937)
- Jumper cable, L=1M AD-05BMMM + AD-05BFFM (P/N 13053938)
- Jumper cable, L=3M AD-05BMMM + AD-05BFFM (P/N 13053939)
- Jumper cable, L=5M AD-05BMMM + AD-05BFFM (P/N 13053940)
- Jumper cable, L=10M AD-05BMMM + AD-05BFFM (P/N 13054148)
- Leader Cable CE/US FF conMID-05 L=1m (14 AWG), P/N 13054151
- Leader Cable CE/US FF conMID-05 L=3m (14 AWG), P/N 13054152
- Leader Cable CE/US FF conMID-05 L=5m (14 AWG), P/N 13054153
- Leader Cable CE/US FF conMID-05 L=10m (14 AWG), P/N 13054154
- Jumper cable CE/US MID-05FF/MM L=0.5m (14 AWG), P/N 13054131
- Jumper cable CE/US MID-05FF/MM L=1m (14 AWG), P/N 13054132
- Jumper cable CE/US MID-05FF/MM L=3m (14 AWG), P/N 13054133
- Jumper cable CE/US MID-05FF/MM L=5m (14 AWG), P/N 13054134
- Jumper cable CE/US MID-05FF/MM L=5m (14 AWG), P/N 13054147
- Cable SJTW 5xAWG 14 black (P/N 13053336),
- Cable SJTW 5xAWG 14 white (P/N 13053697)
- Connector T MID-05 MFFT Wieland (P/N 13054130)
- Connector T MINI -05 MFF (P/N 13053941-01)

6. Cleaning and maintenance

DANGER !
Disconnect from the mains before starting any maintenance or cleaning work

Rinse off loose dirt with low pressure water spray. Wash the housing with a soft brush or sponge and a mild, non-abrasive washing detergent. Rinse it.

Maintenance and service operations are only to be carried out by a qualified person.

Should you need any spare parts, please use ROBE OEM parts.

6.1 Disposing of the product

To preserve the environment please dispose or recycle this product at the end of its life according to the local regulations and codes.

7. ChangeLog

This section summarizes changes in the user manual.

Version of the manual	Date of issue	Description of changes
1.1	20/04/2026	New connectors Wieland
1.2	04/05/2026	Dimensions for Lamari SC 0.5 added
1.3	27/05/2026	Dimensions of all versions of Lamari SC 0.5 added

Specifications are subject to change without notice.

May 27, 2026

Copyright © 2025-2026 Robe Lighting - All rights reserved

Made in CZECH REPUBLIC by ROBE LIGHTING s.r.o. Palackeho 416/20 CZ 75701 Valasske Mezirici

DMX protocol for Lamari 1/2/3/4; Lamari Inground 1/2/3/4;

Version: 1.0 (23 modes in total),

Mode/Channels in all								Mode 1: RGBW(A)-8bit, Mode 2: RGB 8-bit, Mode 3: full RGBW(A)	
1	2	3	4	5	6	7	8-10	Mode 4: White-full control, Mode 5: Reduced RGBW(A)	
4	3	12	3	6	8	15	Reserved	Mode 6- Reduced RGBW(A)+white control	
								Mode 7- full RGBW(A)+virtual colour wheel	
								RGBW(A) / RGB modes	
Mode/channels							DMX Value	Function	Type of control
1	2	3	4	5	6	7			
-	-	-	-	-	-	1		Special functions	
							0	No function	step
								<i>To activate following functions , stop in DMX value for at least 3 sec.</i>	
							1-2	Save current DMX values to fixture as initial DMX values.	step
							3-4	Show saved initial DMX values	step
							5-6	Run factory demo sequences at switching fixture on (without DMX)	step
							7-8	Insect friendly light On (RGBA version only)	step
							9-10	Insect friendly light Off (RGBA version only)	step
							11-255	Reserved	
1	1	1	-	1	1	2		Red	
							0-255	Red LEDs saturation control (0-100%)	proportional
-	-	2	-	-	-	3		Red Fine	
							0-255	Red LEDs saturation control fine	proportional
2	2	3	-	2	2	4		Green	
							0-255	Green LEDs saturation control (0-100%)	proportional
-	-	4	-	-	-	5		Green Fine	
							0-255	Green LEDs saturation control fine	proportional
3	3	5	-	3	3	6		Blue	
							0-255	Blue LEDs saturation control (0-100%)	proportional
-	-	6	-	-	-	7		Blue Fine	
							0-255	Blue LEDs saturation control fine	proportional
4	-	7	-	4	4	8		White (Amber)	
							0-255	White LEDs saturation control (0-100%)	proportional
-	-	8	-	-	-	9		White (Amber) Fine	
							0-255	White LEDs saturation control fine	proportional
-	-	9	1	-	5	10		Green correction	
							0	Uncorrected white	step
							1-127	Minus green --> uncorrected white	proportional
							128	Uncorrected white (128=default)	step
							129-255	Uncorrected white --> Plus green	proportional
-	-	10	2	-	6	11		Colour temperature correction (CTC)	
							0	No function	step
							1-10	Tungsten dimming 2700 K	step
							11-20	Tungsten dimming 3200 K	step
							21-255	Colour temperature changing from 1800 K --> 6500 K	proportional

DMX protocol

Mode/channels							DMX Value	Function	Type of control
1	2	3	4	5	6	7			
								(21-1800K, 66-2700K, 91-3200K,141-4200K, 211-5600K, 255-6500K)	
-	-	-	-	-	-	12		Virtual Colour Wheel	
							0	No function	step
							1-2	White 1800 K	step
							3-4	White 2700 K	step
							5-6	White 3200 K	step
							7-8	White 4200 K	step
							9-10	White 5600 K	step
							11-12	White 6500 K	step
							13	Blue (Blue=full, Red+Green+White/Amber=0)	step
							14-23	Red=0, Green->up,Blue =full, White/Amber=0	proportional
							24	Cyan (Red=0, Green=full, Blue =full, White/Amber=0)	step
							25-34	Red=0, Green=full, Blue->down, White/Amber=0	proportional
							35	Green (Red=0, Green=full, Blue =0, White/Amber=0)	step
							36-45	Red->up, Green=full, Blue=0, White/Amber=0	proportional
							46	Yellow (Red=full, Green=full, Blue=0, White/Amber=0)	step
							47-56	Red=full, Green->down, Blue=0, White/Amber=0	proportional
							57	Red(Red=full, Green=0, Blue=0, White/Amber=0)	step
							58-67	Red=full, Green=0, Blue->up, White/Amber=0	proportional
							68	Magenta (Red=full, Green=0, Blue=full, White/Amber=0)	step
							69-78	Red -> down, Green=0, Blue=full, White/Amber=0	proportional
							79	Blue (Red=0, Green=0, Blue=full, White/Amber=0)	step
								Transition effects	
							80-87	Rainbow effect (with fade time) from slow-> fast	proportional
							88-95	Rainbow effect (without fade time) from slow-> fast	proportional
							96-103	Full dynamic white (1800K->6500K->1800K) (with fade time) from slow-> fast	proportional
							104-111	Full dynamic white (1800K->6500K->1800K) (without fade time) from slow-> fast	proportional
							112-119	Dynamic warm white (1800K-3000K-1800K) (with fade time) from slow-> fast	proportional
							120-127	Dynamic warm white (1800K-3000K-1800K) (without fade time) from slow-> fast	proportional
							128-135	Rainbow effect + full dynamic white (with fade time) from slow-> fast	proportional
							136-143	Rainbow effect + full dynamic white (without fade time) from slow-> fast	proportional
							144-151	Blue/Green effect (with fade time) from slow-> fast	proportional
							152-159	Blue/Green effect (without fade time) from slow-> fast	proportional
							160-167	Red/Blue effect (with fade time) from slow-> fast	proportional
							168-175	Red/Blue effect (without fade time) from slow-> fast	proportional
							176-183	Green/Red effect (with fade time) from slow-> fast	proportional
							184-191	Green/Red effect (without fade time) from slow-> fast	proportional
							192-199	Blue/4000K effect (with fade time) from slow-> fast	proportional
							200-207	Blue/4000K effect (without fade time) from slow-> fast	proportional
							208-215	Green/4000K effect (with fade time) from slow-> fast	proportional
							216-223	Green/4000K effect (without fade time) from slow-> fast	proportional
							224-231	Red/4000K effect (with fade time) from slow-> fast	proportional
							232-239	Red/4000K effect (without fade time) from slow-> fast	proportional
							240-255	Reserved	

DMX protocol

Mode/channels							DMX Value	Function	Type of control
1	2	3	4	5	6	7			
						13		Shutter/Strobe	
							0-31	Shutter closed	step
							32-63	Shutter open	step
							64-95	Strobe-effect from slow to fast	proportional
							96-127	Shutter open	step
							128-143	Opening pulse in sequences from slow to fast	proportional
							144-159	Closing pulse in sequences from fast to slow	proportional
							160-191	Shutter open	step
							192-223	Random strobe-effect from slow to fast	proportional
							224-255	Shutter open	step
-	-	11	3	5	7	14		Dimmer	
							0-255	Light intensity coarse (0-100%)	proportional
-	-	12	-	6	8	15		Dimmer Fine	
							0-255	Light intensity fine	proportional
Copyright © 2025 Robe Lighting s.r.o. - All rights reserved									
All Specifications subject to change without notice									

DMX protocol

DMX protocol for Lamari 1/2/3/4; Lamari Inground 1/2/3/4;

Version: 1.0 (23 modes in total)

Mode/Channels in all				Mode 11: White selection, Mode 12: WW + CW	
11	12	13	14-16	Mode 13: Only dimmer	
3	4	2	Reserved		
TW and PW modes					
Mode/channels			DMX Value	Function	Type of control
11	12	13			
1	-	-	0 - 255	White colour selection White from 2700 K - 6500 K	proportional
-	1	-	0 - 255	Warm White Warm White LEDs saturation control (0-100%)	proportional
-	2	-	0 - 255	Cool White Cool White LEDs saturation control (0-100%)	proportional
2	3	1	0 - 255	Dimmer Light intensity coarse (0 - 100%)	proportional
3	4	2	0 - 255	Dimmer Fine Light intensity fine	proportional
Copyright © 2025 Robe Lighting s.r.o. - All rights reserved					
All Specifications subject to change without notice					

DMX protocol for Lamari 1/2/3/4; Lamari Inground 1/2/3/4;

Version: 1.0 (23 modes in total)

Mode/Channels in all					Mode 17: RGBW(A) pixels, Mode 18: RGB pixels, Mode 19: TW pixels, Mode 20: PW dimmer pixels		
17	18	19	20	21-23			
16	12	8	8	Reserved			
Mode/channels					DMX Value	Function	Type of control
17	18	19	20				
1	1	-	-	0 - 255	Red 1 -Lamari 1/2/3/4 Red LEDs saturation control (0-100%)	proportional	
2	2	-	-	0 - 255	Green 1-Lamari 1/2/3/4 Green LEDs saturation control (0-100%)	proportional	
3	3	-	-	0 - 255	Blue 1-Lamari 1/2/3/4 Blue LEDs saturation control (0-100%)	proportional	
4	-	-	-	0 - 255	White (Amber) 1-Lamari 1/2/3/4 White LEDs saturation control (0-100%)	proportional	
5	4	-	-	0 - 255	Red 2 -Lamari 1/ 2/3/4 Red LEDs saturation control (0-100%)	proportional	
6	5	-	-	0 - 255	Green 2-Lamari 1/2/3/4 Green LEDs saturation control (0-100%)	proportional	
7	6	-	-	0 - 255	Blue 2-Lamari 1/2/3/4 Red LEDs saturation control (0-100%)	proportional	
8	-	-	-	0 - 255	White (Amber) 2-Lamari 1/2/3/4 White LEDs saturation control (0-100%)	proportional	
9	7	-	-	0 - 255	Red 3-Lamari 2/3/4 Red LEDs saturation control (0-100%)	proportional	
10	8	-	-	0 - 255	Green 3-Lamari 2/3/4 Green LEDs saturation control (0-100%)	proportional	
11	9	-	-	0 - 255	Blue 3-Lamari 2/3/4 Blue LEDs saturation control (0-100%)	proportional	
12	-	-	-	0 - 255	White (Amber) 3-Lamari 2/3/4 White LEDs saturation control (0-100%)	proportional	
13	10	-	-	0 - 255	Red 4-Lamari 2/3/4 Red LEDs saturation control (0-100%)	proportional	
14	11	-	-	0 - 255	Green 4-Lamari 2/3/4 Green LEDs saturation control (0-100%)	proportional	
15	12	-	-	0 - 255	Blue 4-Lamari 2/3/4 Blue LEDs saturation control (0-100%)	proportional	
16	-	-	-	0-255	White (Amber) 4 -Lamari 2/3/4 White LEDs saturation control (0-100%)	proportional	
17	13	-	-	0 - 255	Red 5 -Lamari 3/4 Red LEDs saturation control (0-100%)	proportional	
18	14	-	-	0 - 255	Green 5-Lamari 3/4 Green LEDs saturation control (0-100%)	proportional	
19	15	-	-		Blue 5-Lamari 3/4		

DMX protocol

Mode/channels				DMX Value	Function	Type of control
17	18	19	20			
				0 - 255	Blue LEDs saturation control (0-100%)	proportional
20	-	-	-		White (Amber) 5-Lamari 3/4	
				0 - 255	White LEDs saturation control (0-100%)	proportional
21	16	-	-		Red 6 -Lamari 3/4	
				0 - 255	Red LEDs saturation control (0-100%)	proportional
22	17	-	-		Green 6-Lamari 3/4	
				0 - 255	Green LEDs saturation control (0-100%)	proportional
23	18	-	-		Blue 6-Lamari 3/4	
				0 - 255	Red LEDs saturation control (0-100%)	proportional
24	-	-	-		White (Amber) 6-Lamari 3/4	
				0 - 255	White LEDs saturation control (0-100%)	proportional
25	19	-	-		Red 7-Lamari 4	
				0 - 255	Red LEDs saturation control (0-100%)	proportional
26	20	-	-		Green 7-Lamari 4	
				0 - 255	Green LEDs saturation control (0-100%)	proportional
27	21	-	-		Blue 7-Lamari 4	
				0 - 255	Blue LEDs saturation control (0-100%)	proportional
28	-	-	-		White (Amber) 7-Lamari 4	
				0 - 255	White LEDs saturation control (0-100%)	proportional
29	22	-	-		Red 8-Lamari 4	
				0 - 255	Red LEDs saturation control (0-100%)	proportional
30	23	-	-		Green 8-Lamari 4	
				0 - 255	Green LEDs saturation control (0-100%)	proportional
31	24	-	-		Blue 8-Lamari 4	
				0 - 255	Blue LEDs saturation control (0-100%)	proportional
32	-	-	-		White (Amber) 8 -Lamari 4	
				0-255	White LEDs saturation control (0-100%)	proportional
-	-	1	-		Warm White 1 -Lamari 1/2/3/4	
					Warm White LEDs saturation control (0-100%)	proportional
-	-	2	-		Cool White 1-Lamari 1/2/3/4	
				0 - 255	Cool White LEDs saturation control (0-100%)	proportional
-	-	3	-		Warm White 2-Lamari 1/2/3/4	
				0 - 255	Warm White LEDs saturation control (0-100%)	proportional
-	-	4	-		Cool White 2-Lamari 1/2/3/4	
				0 - 255	Cool White LEDs saturation control (0-100%)	proportional
-	-	5	-		Warm White 3-Lamari 2/3/4	
				0 - 255	Warm White LEDs saturation control (0-100%)	proportional
-	-	6	-		Cool White 3-Lamari 2/3/4	
				0 - 255	Cool White LEDs saturation control (0-100%)	proportional
-	-	7	-		Warm White 4 -Lamari 2/3/4	
				0 - 255	Warm White LEDs saturation control (0-100%)	proportional
-	-	8	-		Cool White 4 -Lamari 2/3/4	
				0 - 255	Cool White LEDs saturation control (0-100%)	proportional
-	-	9	-		Warm White 5 -Lamari 3/4	
					Warm White LEDs saturation control (0-100%)	proportional
-	-	10	-		Cool White 5-Lamari 3/4	
				0 - 255	Cool White LEDs saturation control (0-100%)	proportional

DMX protocol

Mode/channels				DMX Value	Function	Type of control
17	18	19	20			
-	-	11	-	0 - 255	Warm White 6-Lamari 3/4 Warm White LEDs saturation control (0-100%)	proportional
-	-	12	-	0 - 255	Cool White 6-Lamari 3/4 Cool White LEDs saturation control (0-100%)	proportional
-	-	13	-	0 - 255	Warm White 7-Lamari 4 Warm White LEDs saturation control (0-100%)	proportional
-	-	14	-	0 - 255	Cool White 7-Lamari 4 Cool White LEDs saturation control (0-100%)	proportional
-	-	15	-	0 - 255	Warm White 8 -Lamari 4 Warm White LEDs saturation control (0-100%)	proportional
-	-	16	-	0 - 255	Cool White 8 -Lamari 4 Cool White LEDs saturation control (0-100%)	proportional
-	-	-	1	0 - 255	Dimmer 1-Lamari 1/2/3/4 Light intensity coarse (0 - 100%)	proportional
-	-	-	2	0 - 255	Dimmer 1 Fine-Lamari 1/2/3/4 Light intensity fine	proportional
-	-	-	3	0 - 255	Dimmer 2-Lamari 1/2/3/4 Light intensity coarse (0 - 100%)	proportional
-	-	-	4	0 - 255	Dimmer 2 Fine -Lamari 1/2/3/4 Light intensity fine	proportional
-	-	-	5	0 - 255	Dimmer 3-Lamari 2/3/4 Light intensity coarse (0 - 100%)	proportional
-	-	-	6	0 - 255	Dimmer 3 Fine-Lamari 2/3/4 Light intensity fine	proportional
-	-	-	7	0 - 255	Dimmer 4-Lamari 2/3/4 Light intensity coarse (0 - 100%)	proportional
-	-	-	8	0-255	Dimmer 4 Fine -Lamari 2/3/4 Light intensity fine	proportional
-	-	-	9	0 - 255	Dimmer 5-Lamari 3/4 Light intensity coarse (0 - 100%)	proportional
-	-	-	10	0 - 255	Dimmer 5 Fine-Lamari 3/4 Light intensity fine	proportional
-	-	-	11	0 - 255	Dimmer 6-Lamari 3/4 Light intensity coarse (0 - 100%)	proportional
-	-	-	12	0 - 255	Dimmer 6 Fine -Lamari 3/4 Light intensity fine	proportional
-	-	-	13	0 - 255	Dimmer 7-Lamari 4 Light intensity coarse (0 - 100%)	proportional
-	-	-	14	0 - 255	Dimmer 7 Fine-Lamari 4 Light intensity fine	proportional
-	-	-	15	0 - 255	Dimmer 8-Lamari 4 Light intensity coarse (0 - 100%)	proportional
-	-	-	16	0-255	Dimmer 8 Fine -Lamari 4 Light intensity fine	proportional
Copyright © 2025 Robe Lighting s.r.o. - All rights reserved						
All Specifications subject to change without notice						