

LAMARI™ 0.5 / 1 / 2 / 3 / 4 M

Our linear LED fixture is the ideal choice for professional lighting, offering outstanding color mixing, particularly in the multichip version. For enhanced safety, the fixture operates at 48V and is controlled via DALI 2 and E-Box Remote series controllers. The fixture's body is made from durable aluminum, boasting IK10 and IP67 ratings, ensuring high resistance to mechanical damage and harsh weather conditions. A wide range of beam angles is available, allowing precise adjustment to meet specific project requirements. The fixture is available in four length variants and offers multiple surface mounting options.



KEY FEATURES

Optic & Control

Advanced technology ensures precise blending of colours, especially in multichip versions. Choose from a variety of beam angles to suit different lighting needs. 48V operation for safe usage in various environments.

Compact design

At only 39 mm of total height, Lamari MC has been designed as a compact and slim LED luminaire suitable for any low-profile application. Available in four length options with multiple mounting configurations.

Durability

Thanks to its tempered glass and high-pressure, extruded aluminum housing, Lamari MC is IK10 and IP67 certified. For more extreme and marine applications, a harsh environment finish option is also available.

COLOURS



RGBW



RGBA

CONTROL & PROTOCOLS



REMOTE



REMOTE

FINISH OPTIONS

* CLOSEST RAL TONE
* HE = Harsh Environment



Graphite Black
RAL 9011*



Grey Aluminium
RAL 9007



Sandstone
RAL 1014*



Pure White
RAL 9010



HE Graphite Black
RAL 9011*



HE Grey Aluminium
RAL 9007



HE Sandstone
RAL 1014*



HE Pure White
RAL 9010



RAL
Custom Paint Colour

OPTIC OPTIONS

SYMMETRICAL



15°



25°



35°



50°



65°



100°

BI-SYMMETRICAL



15°x40°



15°x70°



20°x45°



20°x80°



35°x110°



40°x65°

STANDARD & SPECIFICATION



SPECIFICATION

ELECTRICAL	Input Voltage	48 V			
	Typical Power Consumption	Lamari SC 0.5: 5 W	Lamari MC 1: 10 W		
		Lamari MC 2: 20 W	Lamari MC 3: 30 W		
		Lamari MC 4: 40 W			
OPTICAL	Light Source	Lamari MC 0.5 / 1 / 2 / 3 / 4: 5 / 10 / 20 / 30 / 40 Mid Power LEDs			
	Colour Variants	RGBW (W - 6.500 K) RGBA			
	Beam Angle	Symmetrical:	15° 25° 35° 50° 65° 100°		
		Bi-symmetrical:	15°x40° 15°x70° 20°x45° 20°x80° 35°x110° 40°x65°		
	Linear Louvre (Low Glare Accessories) - Available For	Symmetrical:	15° 25°		
		Bi-symmetrical:	15°x40° 15°x70° 20°x45° 20°x80° 35°x110°		
	Lumen Output Delivered	Lamari MC 1: 509 lm, (MC, RGBA @3000K) TBC	Lamari MC 3: 1527 lm, (MC, RGBA @3000K) TBC		
Lamari MC 2: 1018 lm, (MC, RGBA @3000K) TBC		Lamari MC 4: 1627 lm, (MC, RGBA @3000K) TBC			
Projected Lumen Maintenance	L90B10 >90.000 hrs, Ta = 25°C / 77°F				
CONTROL	Interface Protocol	Via E-Box Remote range, DALI 2			
	E-Box Remote Control Protocols	USITT DMX512, RDM, ArtNet, MA Net, MA Net2, sACN, Kling-Net			
	Operating Modes	Pixel (per 1/2 Foot) or Fixture mode			
	Setting/Addressing	Via Two Row LCD Display with Control Buttons on E-Box Remote or RDM communicator			
	Power Supply	Via E-Box Remote range			
	Connectivity	E-box Remote E-box Remote Basic			
PHYSICAL	Width x Height x Length		Rear:	Side:	
		Lamari MC 0.5	39.5 x 39 x 185 mm (1.46 x 1.54 x 7.28 in.)	39.5 x 39 x 185 mm (1.46 x 1.54 x 7.28 in.)	
		Lamari MC 1	39.5 x 39 x 339 mm (1.56 x 1.54 x 13.35 in.)	39.5 x 39 x 339 mm (1.56 x 1.54 x 13.35 in.)	
		Lamari MC 2	39.5 x 39 x 649 mm (1.56 x 1.54 x 25.55 in.)	39.5 x 39 x 649 mm (1.56 x 1.54 x 25.55 in.)	
		Lamari MC 3	39.5 x 39 x 959 mm (1.56 x 1.54 x 37.76 in.)	39.5 x 39 x 959 mm (1.56 x 1.54 x 37.76 in.)	
	Lamari MC 4	39.5 x 39 x 1269 mm (1.56 x 1.54 x 49.96 in.)	39.5 x 39 x 1269 mm (1.56 x 1.54 x 49.96 in.)		
Weight 1 / 2 / 3 / 4	0.9 kg 2.0 lbs	1.6 kg 3.5 lbs	2.2 kg 4.9 lbs	2.8 kg 6.2 lbs	
Housing	High Pressure Extruded Aluminium Body End Caps – Die-Cast Aluminium Tempered Glass				
Finish Options	Standard Colour	Graphite Black RAL 9011* Grey Aluminium RAL 9007 Pure White RAL 9010 Sandstone RAL 1014*		*Closest RAL Tone	
	Standard Colour Harsh Environment	Graphite Black RAL 9011* Grey Aluminium RAL 9007 Pure White RAL 9010 Sandstone RAL 1014*		*Closest RAL Tone	
	Cost Option	Custom RAL			
Cables/Connections	IP67 Hybrid Connection (Power + Data)				
Mounting Method	Surface Mount With Different Type of Brackets				
Adjustability	+10° (With Standard Mounting Bracket)				
Protection Factor IK Rating	IP67 / Suitable For Wet Locations IK10				
Cooling System	Convection				
Operating Ambient Temperature	-20°C / +40°C (-4°F / +104°F)				
Operating Temperature	+67°C @ Ambient +40°C (+153°F @ Ambient +104°F)				
CERTIFICATION	Listings	ETL / cETL, CE, RoHS, UKCA			
ACCESSORIES	Included Items	CE: Waterproof Cap for MM connector MINI-05	US: Waterproof Cap for MM connector MID-05		
		CE: Waterproof Cap for FF connector MINI-05	US: Waterproof Cap for FF connector MID-05		
		Optical Demo Set for Lamari 0.5 1 2 3 4		Mounting Brackets	
	Not Included Items	Wall Mount Brackets		Wall Mount Scissors Brackets	
		Shield for Lamari:	Rear 0.5 1 2 3 4		Side 0.5 1 2 3 4
	Barndoors (with or without Side Covers) for Lamari 0.5 1 2 3 4				

SPECIFICATION

	CE	US
	DMX - CONNECTOR SOLUTION	DMX - CONNECTOR SOLUTION
	Cable SJTW 5x14 AWG (13053336), standard with bare-end, black - 1/3/5/10 m	Cable SJTW 5x14 AWG (13053336), standard with bare-end, black - 1/3/5/10 m
	Cable SJTW 5x14 AWG (13053697), with bare-end, white (on request) - 1/3/5/10 m	Cable SJTW 5x14 AWG (13053697), with bare-end, white (on request) - 1/3/5/10 m
	Leader CE Cable FF, 0.1 m, MINI-05 (13053978)	Cable UL 20969 (5x18 AWG) - (13054125)
	Jumper Cable CE/US MID-05 FF/MM (5x14 AWG), 0.5 m, (13054131) - 0.5/1/3/5 m	Jumper Cable CE/US MID-05 FF/MM (5x14 AWG), 0.5 m, (13054131) - 0.5/1/3/5 m
	Jumper Cable MINI-05 FF/MM (5x20 AWG), 0.5 m, (13053937-02) - 0.5/1/3/5/10 m	T-connector MID-05 MFF (13054130)
	Cable 5x20 AWG, 0.5 m, with connector MM (Lamari component)	Field Installable Connector MID-05 FF (14-22 AWG) - (13054127)
	Adaptor MID2MINI (13054149)	DMX - BARE-END
	Adaptor MINI2MID (13054150)	Cable SJTW 5x14 AWG (13053336), standard with bare-end, black
	T-connector MID-05 MFF (13054130)	Cable SJTW 5x14 AWG (13053697), with bare-end, white (on req.)
	T-connector MINI-05 MFF (13053941-01)	Cable UL 20969 (5x18 AWG) - (13054125)
	Field Installable Connector MID-05 FF (14-22 AWG) - (13054127)	Junction Box Remote (1x Output) - (10980715)
	DMX - BARE-END	Junction Box Remote (4x Output) - (10980716)
CABLES AND CONNECTORS	Cable SJTW 5x14 AWG (13053336), standard with bare-end, black - 1/3/5/10 m	
	Cable SJTW 5x14 AWG (13053697), with bare-end, white (on request) - 1/3/5/10 m	
	Cable UL 20969 (5x20 AWG), 1 m, (13053481), black	
	Cable UL 20969 (5x20 AWG), 1 m, (13053696), white (on request)	
	Junction Box Remote (4x Output) - (10980716)	
	Junction Box Remote (1x Output) - (10980715)	
	DALI - CONNECTOR SOLUTION	
	Cable SJTW 5x14 AWG (13053336), standard with bare-end, black - 1/3/5/10 m	
	Cable SJTW 5x14 AWG (13053697), with bare-end, white (on request) - 1/3/5/10 m	
	Jumper Cable CE/US MID-05 FF/MM (5x14 AWG), 0.5 m, (13054131) - 0.5/1/3/5 m	
	T-connector MID-05 MFF (13054130)	
	Field Installable Connector MID-05 FF (14-22 AWG) - (13054127)	
	Junction Box Remote (1x Output) - (10980715)	
	DALI - BARE-END	
	Cable SJTW 5x14 AWG (13053336), standard with bare-end, black - 1/3/5/10 m	
	Cable SJTW 5x14 AWG (13053697), with bare-end, white	
	Cable UL 20969 (5x18 AWG) - (13054125)	
	Junction Box Remote (4x Output) - (10980716)	
	Junction Box Remote (1x Output) - (10980715)	

Not Included Items

LAMARI INPUT OPTIONS

STANDARD

UPON REQUEST

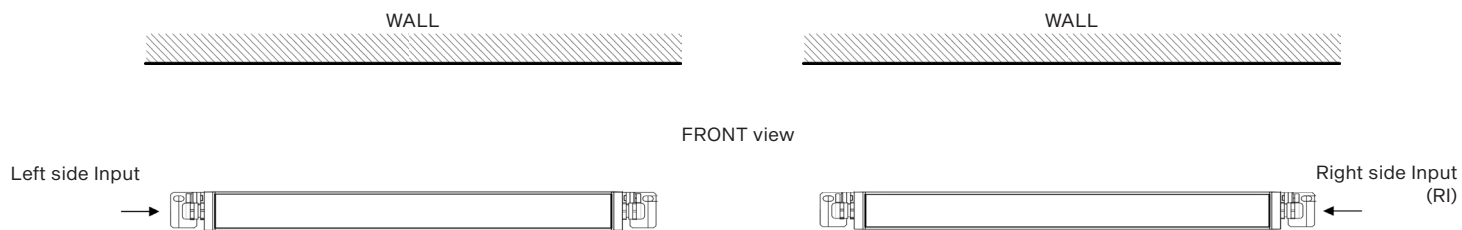

DISTANCE FROM THE WALL

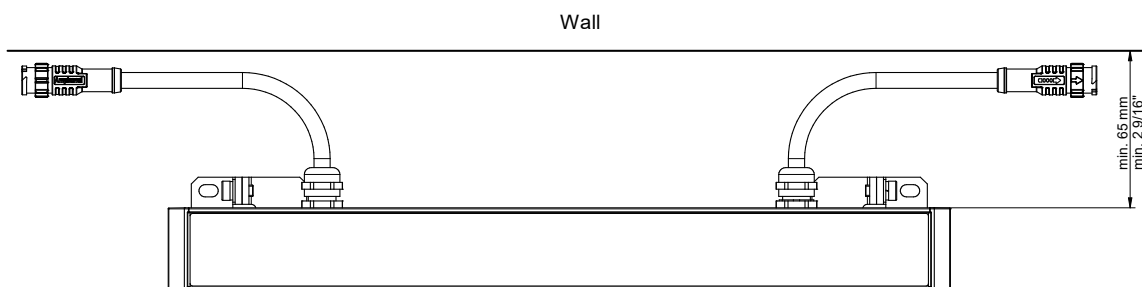

CONTROL AND CONNECTION OPTIONS

STANDARD

- 1) Leader CE Cable FF, 0.1 m, MINI-05 (13053978)
- 2) Cable 5x20 AWG, 0.5 m, with connector MINI-05 MM

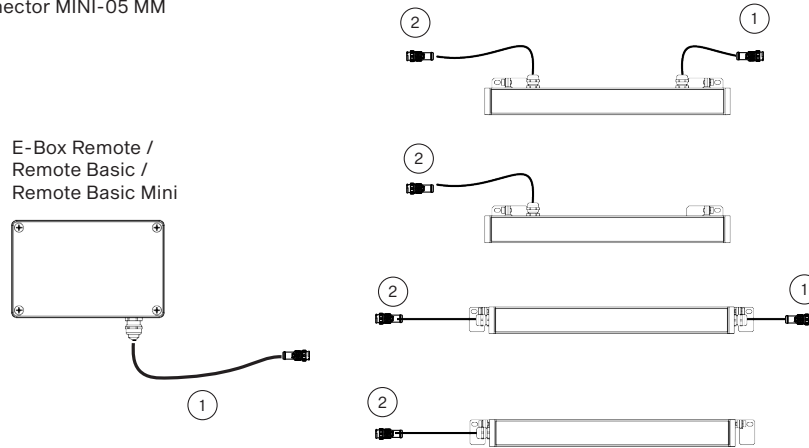

Note: The last unplugged connector must be fitted with a Waterproof Cap to protect the IP rating.

STANDARD WITH JUMPER CABLE

- 1) Leader Cable FF, 0.1 m , CE MINI-05 (13053978)
- 2) Cable 5x20 AWG, 0.5 m, with connector MINI-05 MM
- 3) Jumper Cable MINI-05 FF/MM (20 AWG), 0.5 m (13053937-02)

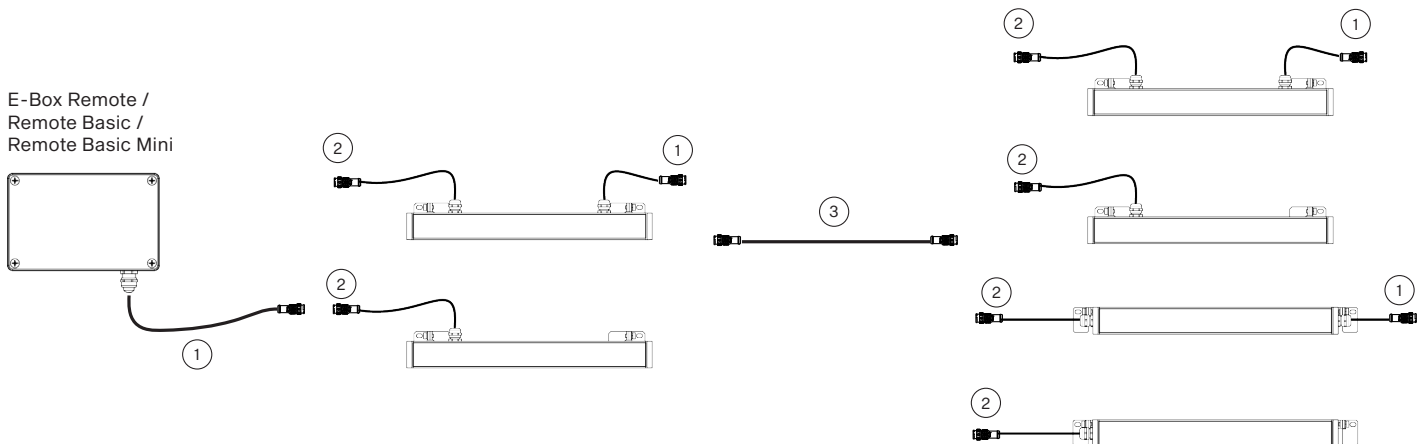

Note: The last unplugged connector must be fitted with a Waterproof Cap to protect the IP rating.

CONTROL AND CONNECTION OPTIONS - CE

DMX - CONNECTOR SOLUTION

A E-BOX REMOTE / REMOTE BASIC / REMOTE BASIC MINI

- 1) SJTW 5x14 AWG (13053336), standard with bare-end, black
- 2) Field Installable Connector MID-05 FF (14-22 AWG) - (13054127)
- 3) T-connector MID-05 MFF (13054130)
- 4) Jumper Cable CE/US MID-05 FF/MM (5x14 AWG), 0.5 m (13054131)
- 5) Adaptor MID2MINI (13054149)
- 6) Cable 5x20 AWG, 0.5 m, with connector MINI-05 MM (Lamari component)

Note: The last unmated connector must be fitted with an Waterproof Cap to protect the IP rating.

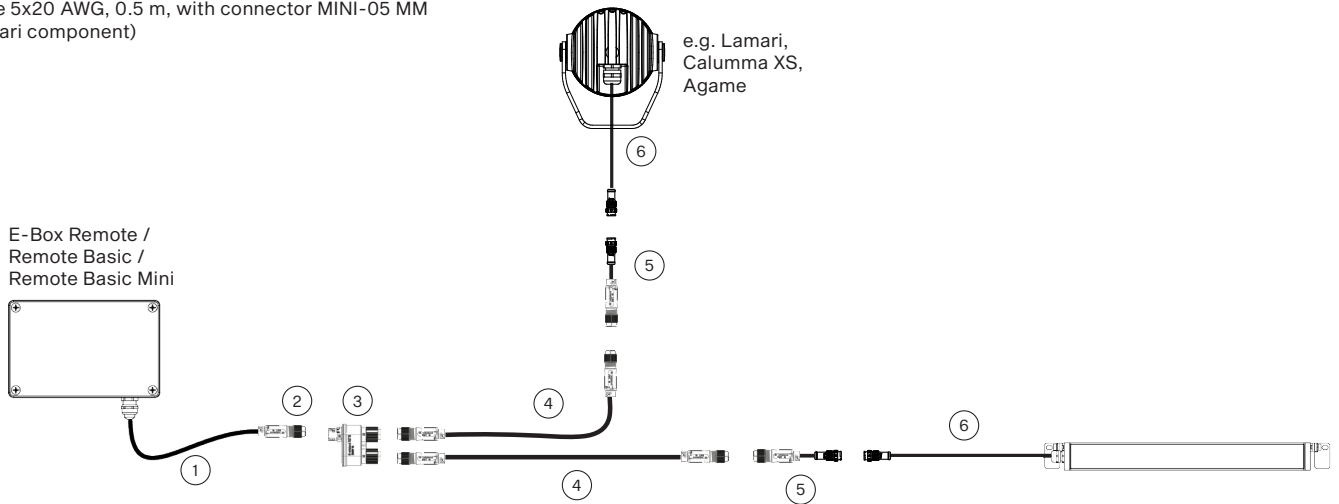

B E-BOX REMOTE / REMOTE BASIC / REMOTE BASIC MINI WITH PANEL CONNECTORS

- 1) Jumper Cable CE/US MID-05 FF/MM (5x14 AWG), 0.5 m (13054131)
- 2) Adaptor MID2MINI (13054149)
- 3) Jumper Cable MINI-05 FF/MM (20 AWG), 0.5 m (13053937-02)
- 4) T-connector MINI-05 MFF (13053941-01)
- 5) Cable 5x20 AWG, 0.5 m, with connector MINI-05 MM (Lamari component)

Note: The last unmated connector must be fitted with an Waterproof Cap to protect the IP rating.

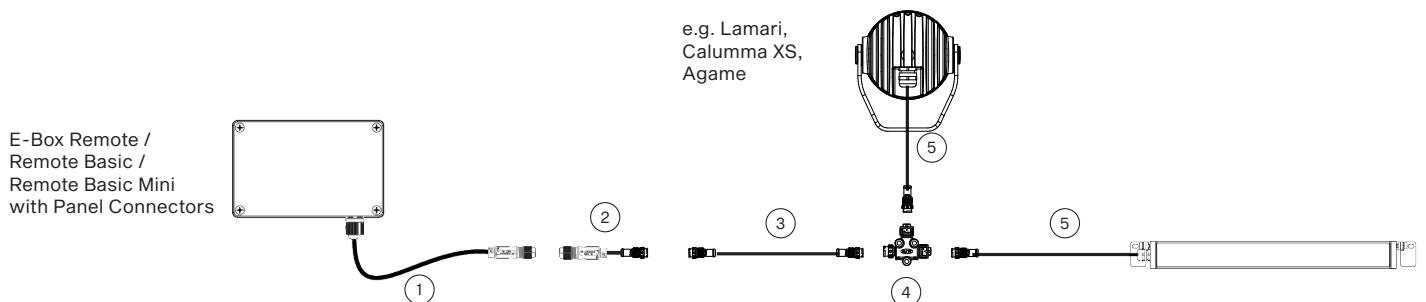

CONTROL AND CONNECTION OPTIONS - CE

DMX - BARE-END CE

- 1) SJTW 5x14 AWG (13053336), standard with bare-end, black
- 2) Junction Box Remote (4x Output) - (10980716)
- 3) Cable UL 20969 (5x20 AWG), 1 m, (13053481), black

Note: The last unmated connector must be fitted with an Waterproof Cap to protect the IP rating.

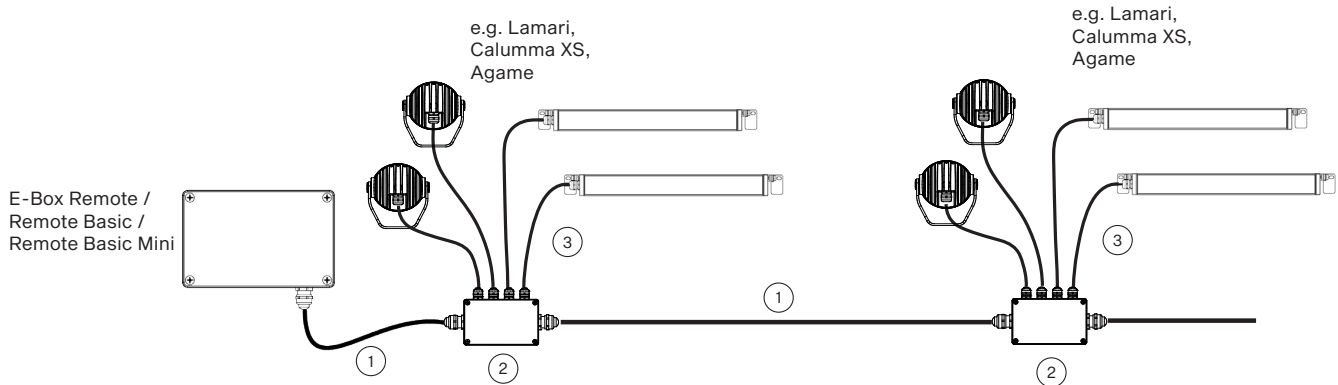

DALI - CONNECTOR SOLUTION CE

- 1) SJTW 5x14 AWG (13053336), standard with bare-end, black
- 2) Field Installable Connector MID-05 FF (14-22 AWG) - (13054126)
- 3) T-connector MID-05 MFF (13054130)
- 4) Jumper Cable CE/US MID-05 FF/MM (5x14 AWG), 0.5 m (13054131)
- 5) Cable UL 20969 (5x18 AWG) - (13054125)
- 6) Junction Box Remote 1x Output - (10980715)

Note: The last unmated connector must be fitted with an Waterproof Cap to protect the IP rating.

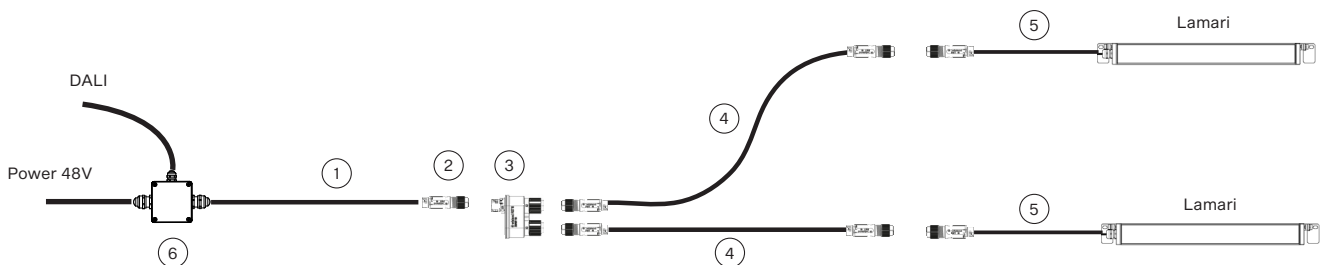

CONTROL AND CONNECTION OPTIONS - CE

DALI - BARE-END

- 1) SJTW 5x14 AWG (13053336), standard with bare-end, black
- 2) Junction Box Remote (4x Output) - (10980716)
- 3) Cable UL 20969 (5x18 AWG) - (13054125)
- 4) Junction Box Remote (1x Output) - (10980715)

Note: The last unmated connector must be fitted with an Waterproof Cap to protect the IP rating.

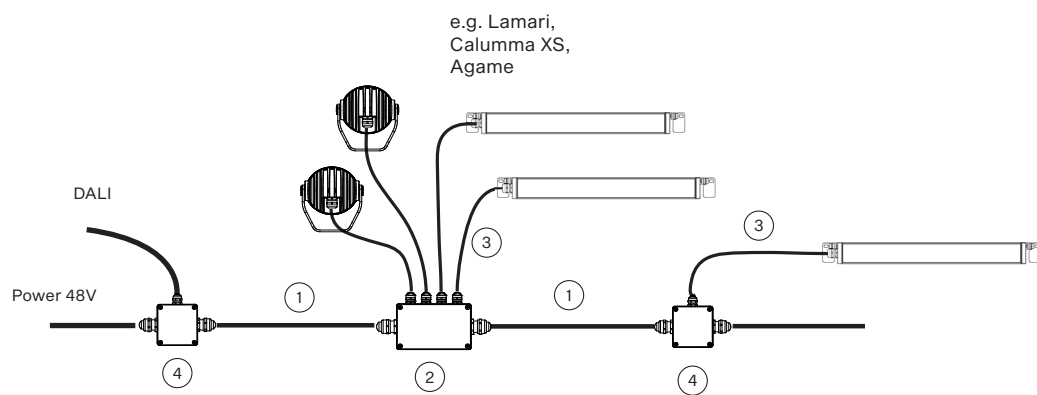

CONTROL AND CONNECTION OPTIONS - US

DMX - CONNECTOR SOLUTION

- 1) SJTW 5x14 AWG (13053336), standard with bare-end, black
- 2) Field Installable Connector MID-05 FF (14-22 AWG) - (13054127)
- 3) T-connector MID-05 MFF (13054130)
- 4) Jumper Cable CE/US MID-05 FF/MM (5x14 AWG), 0.5 m (13054131)
- 5) Cable UL 20969 (5x18 AWG) - (13054125)

Note: The last unmated connector must be fitted with an Waterproof Cap to protect the IP rating.

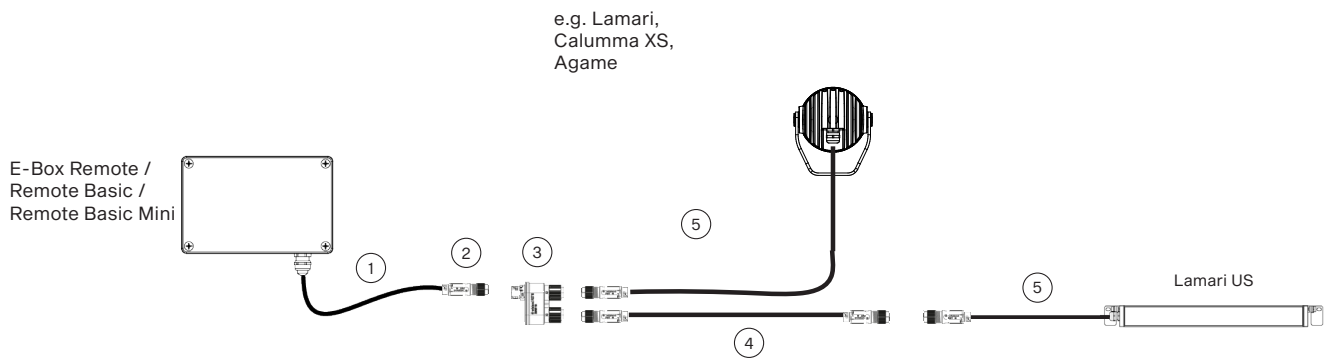

DMX - BARE-END

- 1) SJTW 5x14 AWG (13053336), standard with bare-end, black
- 2) Junction Box Remote (4x Output) - (10980716)
- 3) Cable UL 20969 (5x18 AWG) - (13054125)

Note: The last unmated connector must be fitted with an Waterproof Cap to protect the IP rating.

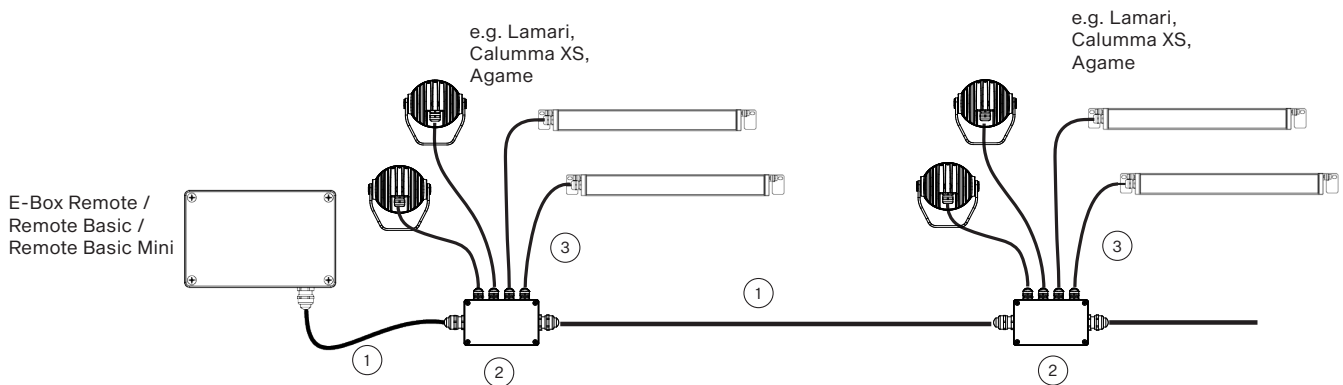

LAMARI CABLE ENTRY OPTIONS

Rear IN/OUT Version



Rear IN Version



Side IN/OUT Version



Side IN Version

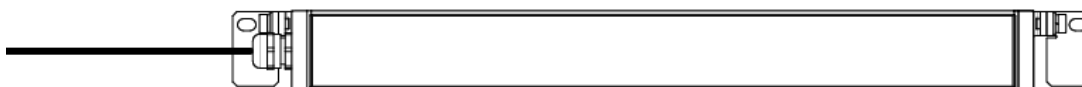

DIMENSIONS

Rear IN/OUT Version

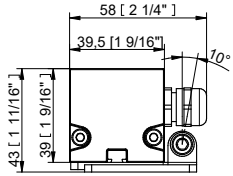

Wall

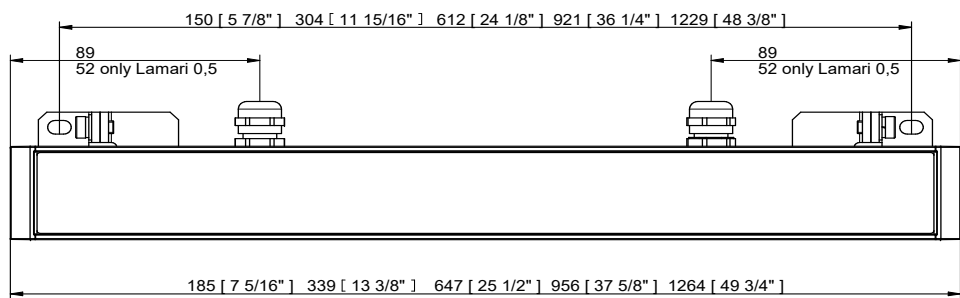

Rear IN Version

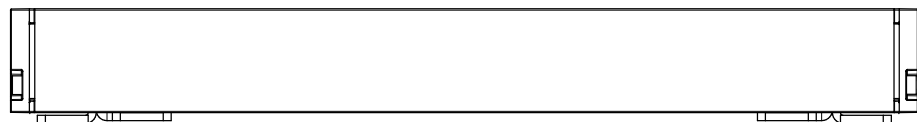
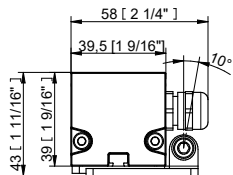

Wall

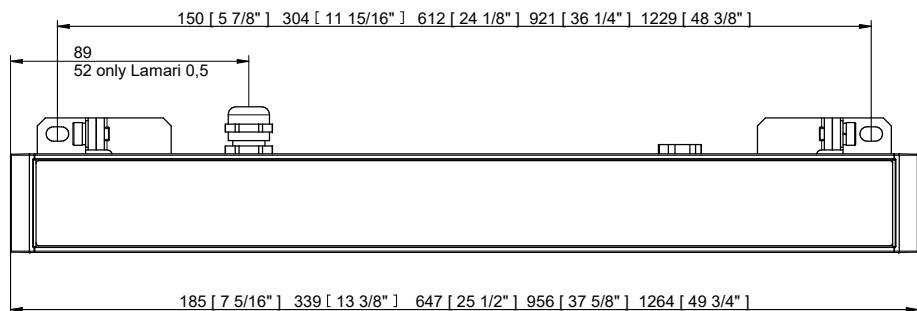

Side IN/OUT Version

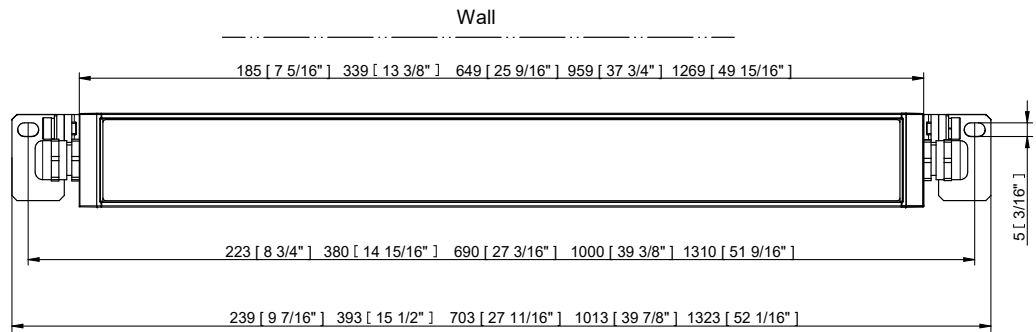
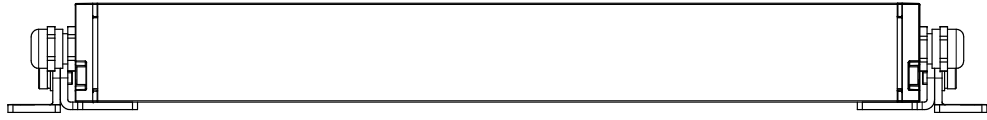
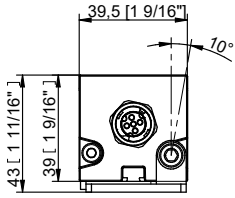

Side IN Version

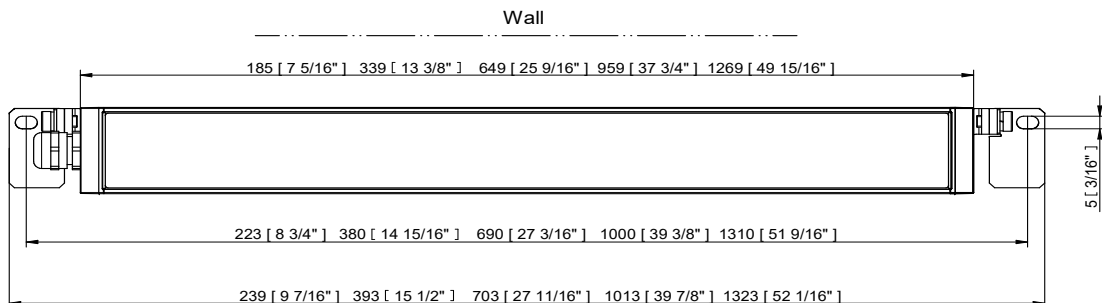
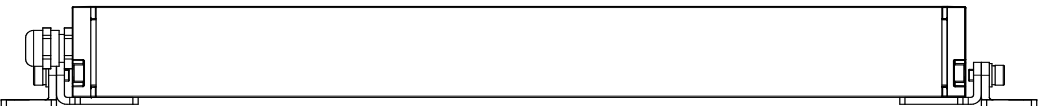
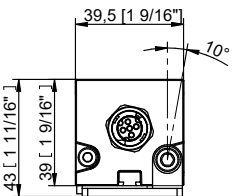

ACCESSORIES

Barndoors for Lamari Side

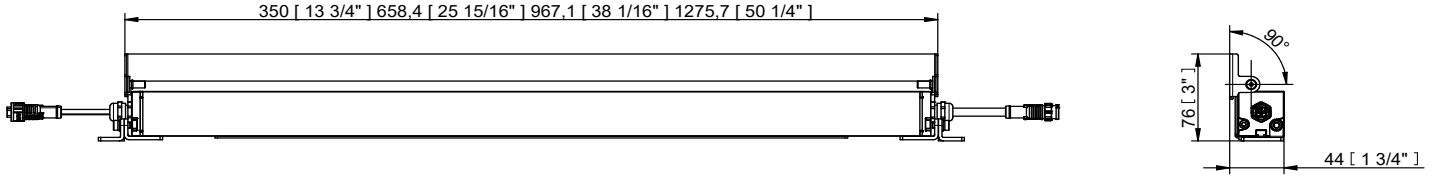

Barndoors for Lamari Rear

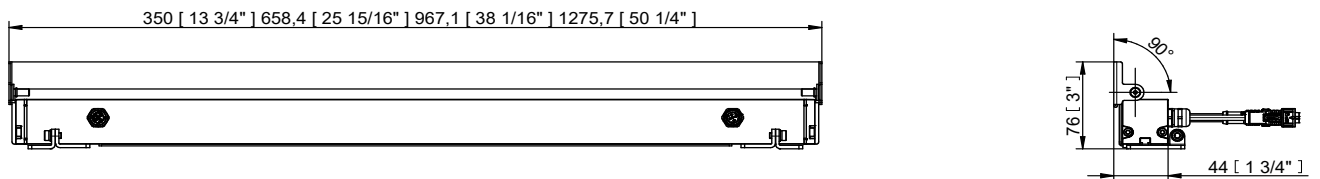

Shields for Lamari Side

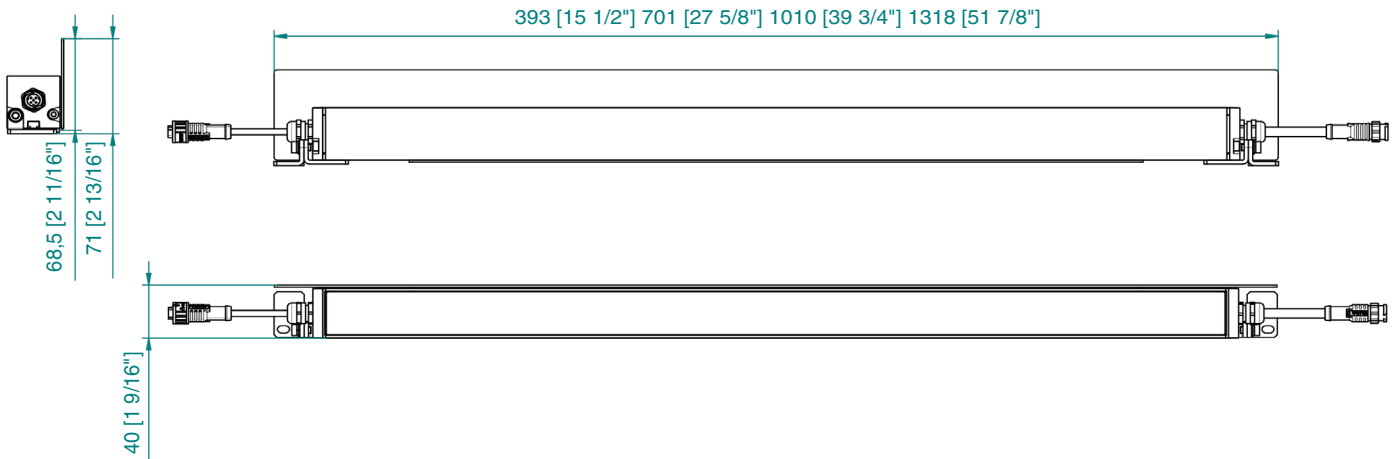

Shields for Lamari Rear

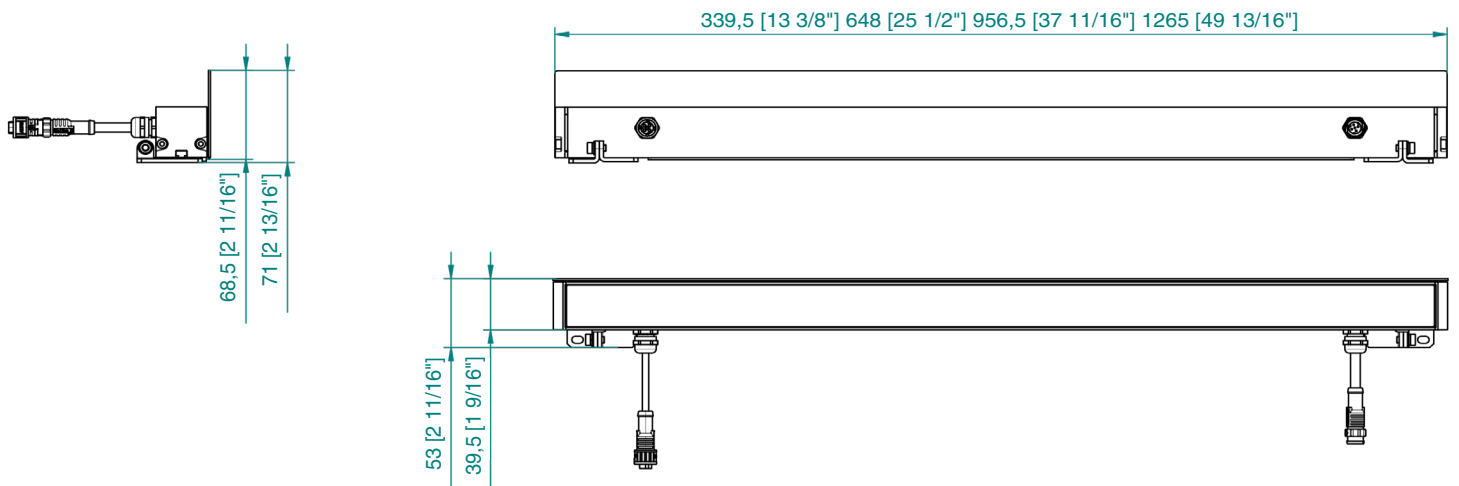

BI-SYMMETRICAL BEAM ANGLES

Bi-symmetrical: 15°x40°, 15°x70°, 20°x45°, 20°x80°, 35°x110°, 40°x65°

